

PROCENTEC



ComBricks

User Manual

User Manual ComBricks

Monitoring, Networking and Control



- PROFIBUS data hub for repeaters and fiber optic modules
- Transparent for all PROFIBUS DP protocols
- ProfiTrace for monitoring 4 networks
- Drives 32 modules (10 communication modules)
- Hot swap
- Powerful web server
- 100 Mbps Ethernet
- 12 Mbps PROFIBUS
- DIN-rail
- IP 20

Safety Guidelines

This manual contains notices which you should observe to ensure your own personal safety, as well as to protect the product and connected equipment. These notices are highlighted in the manual by a warning sign and are marked as follows according to the level of danger:



Draws your attention to important information on handling the product, a particular part of the documentation or the correct functioning of the product.

Warning

This device and its components may only be used for the applications described in this manual and only in connection with devices or components that comply with PROFIBUS and RS-485 interface.

This product can only function correctly and safely if it is transported, stored, set up, installed, operated and maintained as recommended. ComBricks is a CE class A product. In a domestic environment it may cause radio interference in which case the user may be required to take adequate measures.

Warranty

Warranty is void if you open ComBricks.

Qualified Technicians

Only qualified technicians should be allowed to install and work with this equipment. Qualified technicians are defined as persons who are authorized to commission, to ground, to tag circuits and systems in accordance with established safety practices and standards. It is recommended that the technicians carry a Certified PROFIBUS Installer or Certified PROFIBUS Engineer certificate.

Disclaimer of Liability

We have checked the contents of this manual as much as possible. Since deviations cannot be precluded entirely, we cannot guarantee full agreement. However, the content in this manual is reviewed regularly and necessary corrections will be included in subsequent editions. Suggestions for improvements are welcome.

Copyright © 2019 PROCENTEC

All rights reserved. No part of this publication may be reproduced, stored in a retrieval system, or transmitted, in any form or by any means, electronic, mechanical, photocopying, recording or otherwise, without the prior written permission of the publisher.

ComBricks is a registered trademark of PROCENTEC. Other products or company names are or may be registered trademarks and are the property of their respective companies.

Important information

Purpose of the Manual

This user manual provides information how to work with ComBricks.

Recycling and Disposal

The parts of the ComBricks can be recycled. For further information about environment-friendly recycling and the procedure for disposing of your old equipment, please contact:

PROCENTEC
Klopperman 16
2292 JD WATERINGEN
The Netherlands

Tel.: +31-(0)174-671800
Fax: +31-(0)174-671801
Email: info@procentec.com

Document Updates

You can obtain constantly updated information on PROCENTEC products on the Internet at www.procentec.com

You can also contact PROCENTEC Customer Support:

- by phone at +31-(0)174-671800
- by fax at +31-(0)174-671801
- by email at support@procentec.com

Contents

Important information.....	4
1 Product description.....	10
1.1 Introduction.....	10
1.2 Application areas.....	10
1.3 Product features.....	10
1.4 Modular PROFIBUS repeaters.....	11
1.4.1 Cable Redundancy.....	12
1.4.2 Comparison between ProfiHub and ComBricks.....	13
1.4.3 Typical applications.....	13
1.5 ProfiTrace OE - Remote monitoring in a web browser.....	14
1.5.1 Web server.....	14
1.5.2 Email.....	15
1.5.3 Channel List.....	15
1.5.4 Comparison between ComBricks and ProfiTrace 2.....	15
1.5.5 Offshore applications.....	16
1.5.6 Mining applications.....	16
1.5.7 Robot cells.....	17
1.5.8 Logistics.....	17
1.5.9 Traffic control.....	18
1.5.10 Cranes.....	18
1.5.11 Other applications.....	19
1.6 Output control.....	19
1.7 CommDTM.....	20
2 Quick start.....	21
2.1 Quick start checklist.....	21
2.2 Prepare the backplane.....	22
2.3 Insert modules.....	22
2.4 Configure the repeater modules.....	22
2.5 Wire the repeater modules.....	22
2.6 Power the Head Station.....	22
2.7 Customizing the IP number through the web server.....	22
2.8 Customizing the IP number through the Discovery Tool.....	24
2.9 Checking the modules and the administrative info in the web server.....	25
2.10 Testing ProfiTrace OE on the PROFIBUS installation.....	26
2.11 Resetting the Head Station.....	27
3 Installation instructions.....	28
3.1 Location.....	28
3.2 Position.....	28
3.3 Mounting and un-mounting backplane units.....	28
3.4 Adding backplane units.....	29
3.5 Detaching backplane units.....	30
3.6 Inserting modules.....	31
3.7 Removing modules.....	31
3.8 Wiring Ethernet.....	32
3.9 Power Supply.....	34
3.9.1 Procedure.....	34
3.9.2 Testing and commissioning.....	34
3.10 Configuring repeater modules.....	36
3.10.1 Customizing the PROFIBUS network (NW0/NW1).....	36
3.10.2 Redundancy (RED).....	36
3.10.3 Hardware or software settings (H/S).....	37
3.11 Wiring repeater modules.....	38

3.11.1	Screw terminals	39
3.11.2	DB9 connector	40
3.11.3	Testing and commissioning	40
4	Web server	41
4.1	Status	42
4.2	Channel list	44
4.3	System log	45
4.4	Diagnostic slave info	46
4.4.1	ProfiHub diagnostic slave overview	47
4.5	General configuration	47
4.6	Network configuration	48
4.7	IP Configuration	50
4.7.1	Server port configuration	50
4.8	Output Control	51
4.9	Password setup and login	52
4.9.1	Access rights	52
4.9.2	Password best practice	53
4.9.3	External protocols.....	54
4.9.4	Clearing password(s)	54
4.10	License update.....	55
4.11	Document download page	56
4.12	Email account config.....	57
4.12.1	Alive email	58
4.12.2	Email Troubleshooting.....	59
4.13	Device Management.....	59
4.13.1	Backup settings to SD-Card.....	60
4.13.2	Restore settings from SD-Card	60
4.13.3	Restore settings to factory defaults	60
4.13.4	Clear all data	60
4.13.5	Restart the device.....	60
4.13.6	Maintenance mode	60
4.14	Diagnostic Slave configuration	61
5	ProfiTrace OE.....	63
5.1	Live List	63
5.1.1	Updating the GSD file library	64
5.2	Statistics.....	65
5.3	Message recording	66
5.4	Email & Log event configuration	67
5.5	SNMP event config	68
5.6	Tag name configuration.....	69
5.7	Oscilloscope images.....	71
5.7.1	Oscilloscope Configuration	72
5.7.2	Oscilloscope Images	73
5.7.3	Oscilloscope errors	73
5.8	Bar graph	75
5.9	Streaming with ProfiTrace 2	75
5.10	Summary of Statistics and Events.....	78
6	Head Station 1A/1B/1C	80
6.1	Overview.....	80
6.2	Relay contact	81
6.3	SD card.....	81
6.3.1	Inserting/replacing the SD card	81
6.3.2	Life cycle of the SD card.....	82
6.3.3	Directories and files	82
6.4	Audio jack	83

6.5	Switch navigation of the Head Station 1A/1B/1C.....	84
6.6	LEDs on the Head Station	85
7	Repeater modules (RS-485)	87
7.1	Multiple channels per module.....	88
7.2	Channel structure	89
7.3	EMC barrier.....	90
7.4	Grounding system.....	90
7.5	Baudrate detection.....	90
7.6	PROFIBUS DP cable lengths	90
7.7	PROFIBUS DP cable specifications	91
7.8	PROFIBUS DP cable types	92
7.9	Redundancy.....	93
7.10	Mixing with other repeaters.....	94
7.11	LEDs of the repeater module.....	95
8	RS-485-IS Barrier module	96
8.1	Compliance and certificates	97
8.2	Channel structure	98
8.3	Connecting the cable.....	98
8.4	Grounding system.....	98
8.5	Baudrate detection.....	98
8.6	PROFIBUS DP cable lengths	99
8.7	PROFIBUS DP cable specifications	99
8.8	LEDs and DIP switches of the repeater module.....	100
8.9	Redundancy.....	100
9	Fiber optic module (2FO-001)	101
9.1	Topologies	101
9.1.1	Bus topology with ComBricks	102
9.1.2	Star/Hub topology with ComBricks	102
9.2	Delay time.....	102
9.3	Baudrate detection.....	103
9.4	Fiber optic modules in redundancy mode.....	103
9.5	Use of FO modules in combination with other brands.....	103
10	Fiber Optic Ring module (FOR-MM1 / SM1 / XM1)	104
10.1	Topologies	104
10.2	Delay time.....	105
10.3	Dipswitches.....	107
10.4	LEDs	108
10.5	Setting up Fiber Optic alarms	108
11	PROFIBUS Slave Module PBS-001	111
11.1	Status LEDs	111
11.1.1	RDY LED	112
11.1.2	PROFIBUS LEDs	112
11.1.3	Dipswitches.....	112
11.2	Quick Start checklist	114
11.3	Setting up the slave module	114
11.3.1	Hardware addressing.....	115
11.3.2	Software addressing	116
11.4	Remote I/O mode	117
11.4.1	Strict Check Configuration	119
11.4.2	Failsafe behaviour of outputs	119
11.4.3	Input test patterns.....	120
11.5	DP/DP coupling or Gateway mode	122
11.6	PROFIBUS / PROFINET gateway	123

11.7	Data consistency.....	124
11.7.1	Consistency over 2 bytes.....	125
11.7.2	Consistency over 4 bytes.....	125
11.7.3	Consistency over 8 bytes.....	126
12	PA Link/Coupler module.....	127
12.1	Quick Start checklist.....	128
12.2	Monitoring mode.....	129
12.2.1	Module status.....	129
12.2.2	PA oscilloscope images.....	130
12.2.3	PA Bar Graph.....	130
12.2.4	PA measurements.....	131
12.2.5	Oscilloscope configuration.....	132
12.3	Link mode (module firmware v2.10.1 and higher only).....	133
12.3.1	Converting PA GSD files.....	133
12.3.2	Link configuration – bus parameters.....	133
12.3.3	Cycle time calculations.....	134
12.4	Coupler mode.....	134
12.4.1	Bus Parameters.....	134
12.5	Physical layer.....	135
12.5.1	Connecting a PA segment.....	135
12.5.2	Cable specifications.....	136
12.5.3	Spur lines.....	137
12.5.4	Current consumption calculations.....	137
12.5.5	Voltage at the end of the segment.....	138
13	PROFINET Device PND-001.....	139
13.1	Topologies.....	139
13.2	Status LEDs.....	140
13.2.1	RDY LED.....	140
13.2.2	PROFINET LEDs.....	141
13.3	Quick Start checklist.....	142
13.4	Identification and name assignment.....	143
13.4.1	MAC address.....	143
13.4.2	Assigning a custom name.....	143
13.4.3	Assigning a pre-defined name.....	144
13.5	Remote I/O mode.....	144
13.6	PN/PN coupling or Proxy mode.....	145
13.7	PROFINET / PROFIBUS proxy.....	146
14	CommDTM.....	148
14.1	Installing drivers, CommDTM and server.....	148
14.2	Setting up the PCD server.....	148
14.3	Using the CommDTM.....	149
15	OPC.....	152
15.1	Installing the OPC drivers.....	152
15.2	Setting up a stream.....	153
15.3	Selecting OPC tags.....	153
15.4	Activating the OPC server.....	154
16	SNMP.....	157
16.1	List of data items.....	157
16.2	Viewing the MIB file.....	158
16.3	Viewing SNMP traps.....	159
17	Firmware updates.....	161
17.1	Updating the Head Station.....	161
17.2	Updating modules.....	163

18	Tips and Tricks	164
18.1	Ident Number lookup	164
18.2	Solution for secured email connections	164
18.3	IP address adjustment tool.....	164
18.4	Free Wi-Fi channel detector	164
18.5	Some SNMP tools	164
19	Technical Data - ComBricks in general	165
20	Technical Data - Head Station 1A/1B/1C.....	166
21	Technical Data - SCOPE Repeater (101-201210).....	169
22	Technical Data - 2 Channel Repeater (101-201102)	173
23	Technical Data - 1 Channel Repeater (101-201101)	176
24	Technical Data - Fiber Optic Module (101-201510).....	179
25	Technical Data - Fiber Optic Ring MM1 (101-201530).....	182
26	Technical Data - Fiber Optic Ring SM1 (101-201531)	186
27	Technical Data - Fiber Optic Ring XM1 (101-201532)	190
28	Technical Data - SALT Repeater (101-201710).....	193
29	Technical Data - PA Module (101-201610)	196
30	Technical Data - 4 CH Relay Module (101-210210)	199
31	Technical Data - 8 CH D-out Module (101-210110).....	200
32	Technical Data - 8 CH D-in Module (101-210010)	201
33	Technical Data – RS-485-IS Barrier (101-201410)	202
34	Technical Data - PROFIBUS Slave Module PBS-001.....	204
35	Technical Data - PROFINET Device PND001	206
36	Technical Data - 6A Power Module T1 (101-230010)	208
37	Frequently asked questions / FAQ	210
38	Products and spare parts	213
39	Glossary	218
40	Revision history	223
41	Other PROCENTEC products.....	224
42	Sales offices and distributors	226
43	Certificates	231
44	About PROCENTEC	235
45	Notes	236

1 Product description

1.1 Introduction

ComBricks™ - The first PROFIBUS and PROFINET-based automation system that unites network components, permanent monitoring with ProfiTrace and remote I/O.

ComBricks is a modular system that allows a mix of automation components on a backplane. Repeater modules can be inserted next to a PROFIBUS slave and at the same time, in a web browser over Ethernet, the condition of the installation can be remotely inspected with ProfiTrace OE.



1.2 Application areas

- Remote maintenance station with ProfiTrace OE
- Modular repeater backbone with hot swap
- Transparent data hub (repeaters, fiber optic, RS-485-IS, DP slave, PROFINET, etc.)

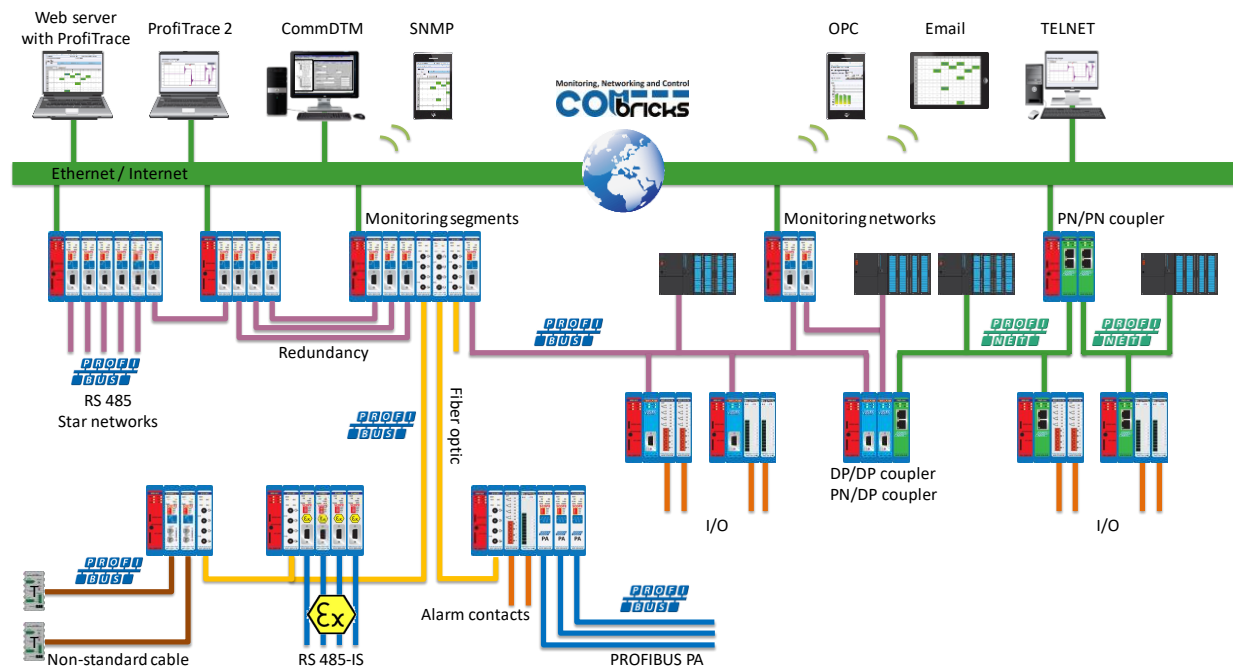

1.3 Product features

- Drives 32 modules (10 high-speed modules)
- Wide range of modules available
- Hot swap and extendible
- Powerful web server
- ProfiTrace OE for monitoring 4 networks
- Multi-language
- DIN-rail mounting
- IP 20

1.4 Modular PROFIBUS repeaters

The current trend in PROFIBUS projects is to use segmentation with repeaters, fiber optic and ProfiHubs to bridge the common faults of the end-user concerning his cabling difficulties. ComBricks adds another important element; the creation of modular and random repeater hubs which can be maintained remotely with a permanent internal ProfiTrace (see **Fig. 1**).

ComBricks is based on a backplane which can hold up to 10 hot swap repeater modules. Each module has one or two channels (so a total of max 20 galvanic isolated transparent segments). Every channel can handle 31 PROFIBUS stations and maximum 1200 m cable length (depends on the baudrate). **Fig. 2** illustrates some configurations.

Each channel has a fail-safe circuit which ensures that the remainder of the PROFIBUS network continues to operate correctly and that the availability of the installation remains optimal.

The connection of the bus cable allows for a high degree of flexibility as the repeater modules contain both a 9-pin and screw connector.

It is possible to dynamically exchange equipment during operation. ComBricks is ideal for flow meters, pH analysers, actuators, drives and especially motor control centres that make use of drawer systems.

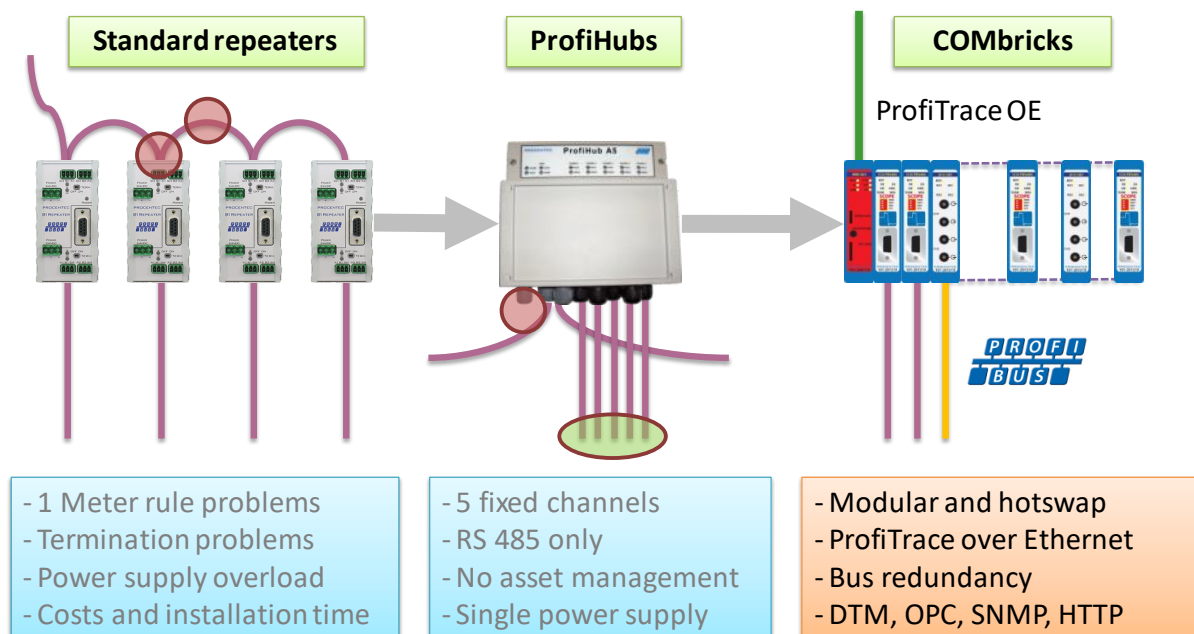

Fig. 1 - Latest trend in segmentation

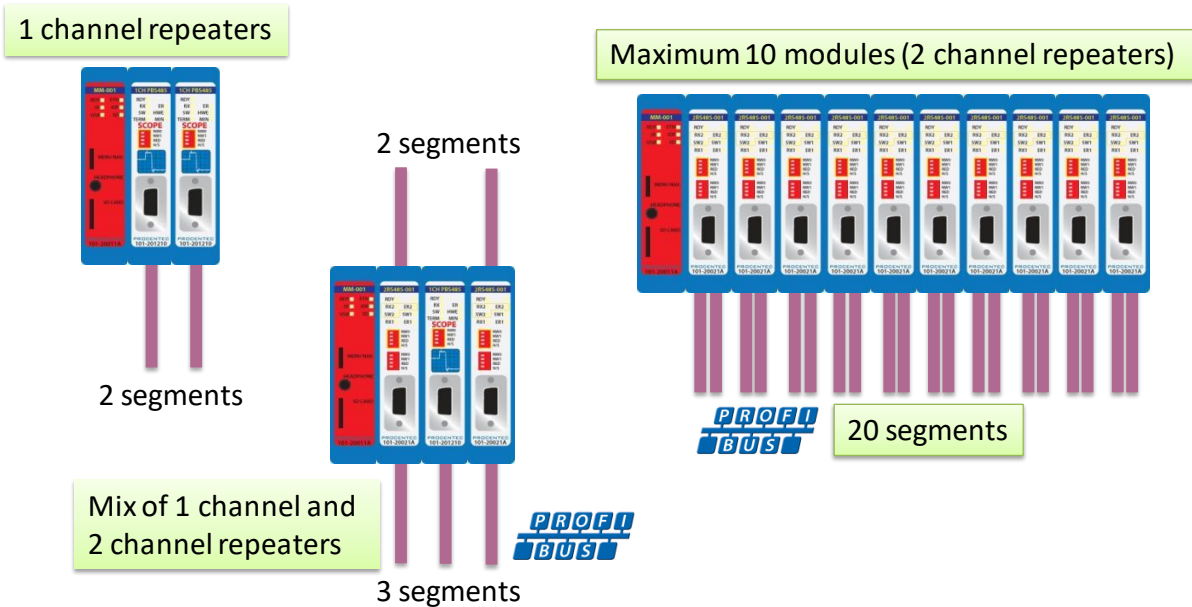

Fig. 2 - Repeater configuration examples

1.4.1 Cable Redundancy

The bus redundancy technology of the repeater modules is very advanced. A redundant system can be built using 10 parallel cables. This architecture provides extremely high availability. Most suppliers only allow 2 cables (see Fig. 3).

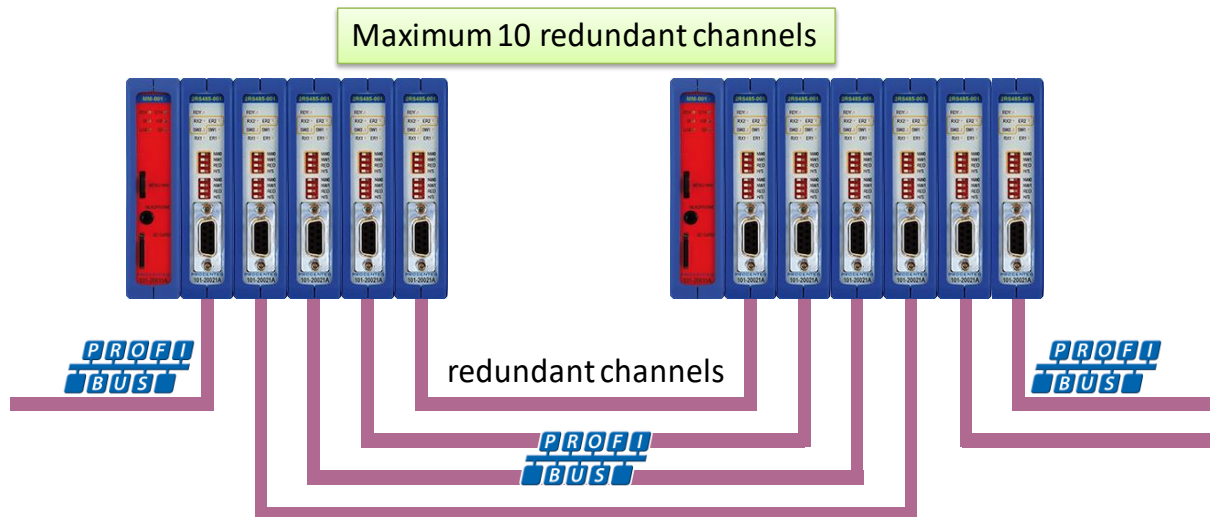

Fig. 3 - Redundancy configuration example

1.4.2 Comparison between ProfiHub and ComBricks

ProfiHub A5 and B5 (simple)	ComBricks (flexible and high-tech)
<ul style="list-style-type: none">• One component• PROFIBUS• RS-485 only• Easy installation• IP 65 version• Low cost	<ul style="list-style-type: none">• Modular• Multi interface• Multi network• ProfiTrace OE• Asset management• Light weight

1.4.3 Typical applications

- Repeaters with permanent ProfiTrace
- Removable drives and motors
- Star, tree and bus structured networks
- Motor control centers (drawers)
- Redundancy for high availability
- EMC vulnerable applications
- Spur lines
- Isolator for sensitive devices

1.5 ProfiTrace OE - Remote monitoring in a web browser

Permanent and simultaneous monitoring of 4 PROFIBUS networks is a powerful feature of ComBricks. Global projects and a shortage of (qualified) technical staff members are causing significant capacity problems. ComBricks offers a solution by remotely monitoring PROFIBUS installations over the Internet and alerting the user by email.

The user can simply connect surrounding PROFIBUS networks and every network can be set to a unique baudrate. The modular technology of ComBricks enables the network to be monitored when multiple repeater modules are installed. All transparent messages from the backplane are constantly analysed.

Up to 10 Repeater modules with 2 channels each (20 galvanic isolated segments in total) can be inserted into the backplane. Using DIP switches or the web server, repeater modules can be assigned to a network group. This ensures isolated communication from the repeaters which are assigned to other network groups; the networks are not combined or connected in any way. Only the Head Station can see all networks groups.

1.5.1 Web server

A web server with a ProfiTrace shell visualizes the information in an understandable format (ProfiTrace OE). Because of the web browser, additional software is NOT required and a constant connection with a PC to the ComBricks is NOT necessary.

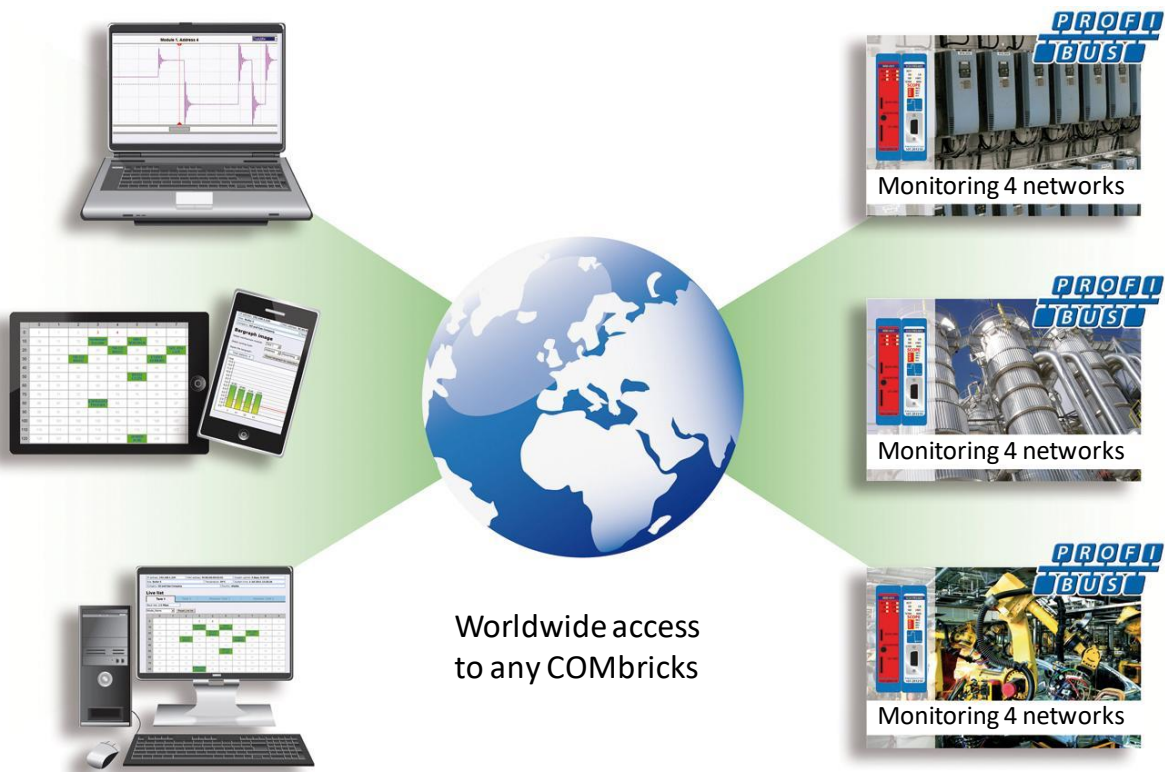

The monitoring and logging is performed by the repeater modules which are inserted in the backplane. ComBricks is the first system that has integrated a busmonitor in network components. Deploying ComBricks repeaters for regular automation means automatic availability of ProfiTrace OE.

1.5.2 Email

Email messages provide real-time alerts in the event of detected faults in the PROFIBUS communication. These email alerts are easy to set up in the web server.

1.5.3 Channel List

A brand new functionality within ProfiTrace OE is the Channel List. It gives a detailed overview of all repeater channels (segments) and all connected stations.

1.5.4 Comparison between ComBricks and ProfiTrace 2

The application area for ComBricks (ProfiTrace OE) compared to ProfiTrace 2 is completely different. ProfiTrace OE should be seen as a watchdog and ProfiTrace 2 as the mobile analyzer to do on-site work.

ProfiTrace 2 (troubleshooting on-site)	ComBricks (watchdog)
<ul style="list-style-type: none">• USB (power supply)• Mobile• Software	<ul style="list-style-type: none">• Ethernet / Internet• Permanent installation• Web server
<ul style="list-style-type: none">• C1 Master• Triggers and filters• Large file recording• Reporting• Fast	<ul style="list-style-type: none">• Multi network monitor• Multi access• Email and Log

1.5.5 Offshore applications

With satellite internet offshore PROFIBUS networks can be remotely monitored. Emails can inform the mainland about the status of the installation.

These applications simplify maintenance and eliminate the hassle to fly an expert over to fix a possible problem. On the LAN local technicians can also monitor the networks.

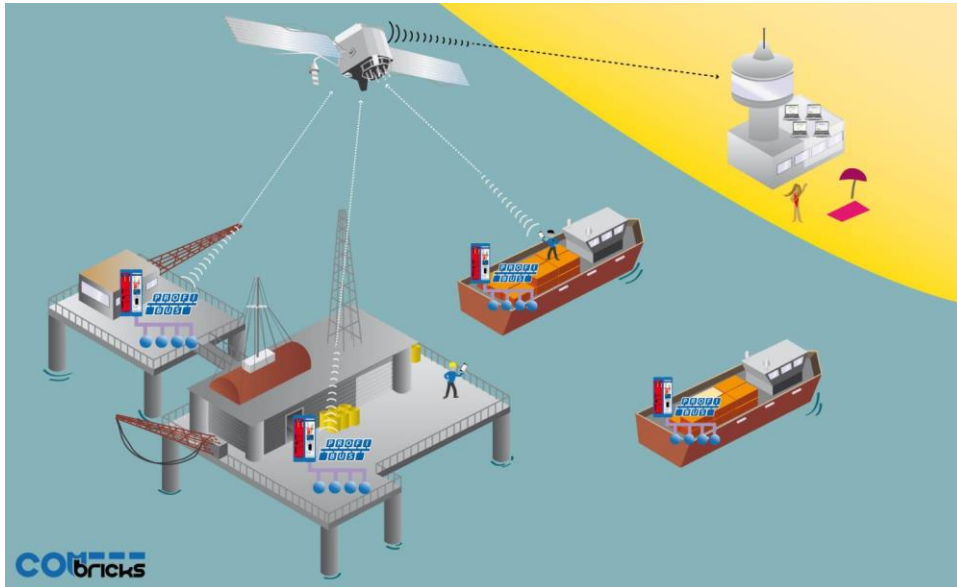

Fig. 4 - Offshore applications

1.5.6 Mining applications

Because of the depth, gasses and inaccessible areas, ComBricks is required to keep the control room and the experts on a distance to monitor the PROFIBUS installations.

Multiple WLAN routers can bring Ethernet up to the surface.

With DTM technology the devices can also be diagnosed and parameterized.



Fig. 5 - Mining applications

1.5.7 Robot cells

Robot cells are hazardous environments with many safety zones. Crossing a safety border can cause a machine shutdown and restarting can take a long time. Measuring PROFIBUS remotely decreases costs and improves human safety.



Fig. 6 - Robot cells

1.5.8 Logistics

In demanding high-speed applications, ComBricks is ideal. The technician does not have to touch the installation and can measure the network from a distance. This is also convenient if the installation is behind a high-security zone such as baggage handling systems at airports, or parcel handling systems.



Fig. 7 - Baggage handling or parcel systems

1.5.9 Traffic control

When distance and downtime are critical factors, ComBricks can be very helpful. Difficult to reach speed indicators above the highway can be monitored from the road-side control cabinet, or even from the control room.

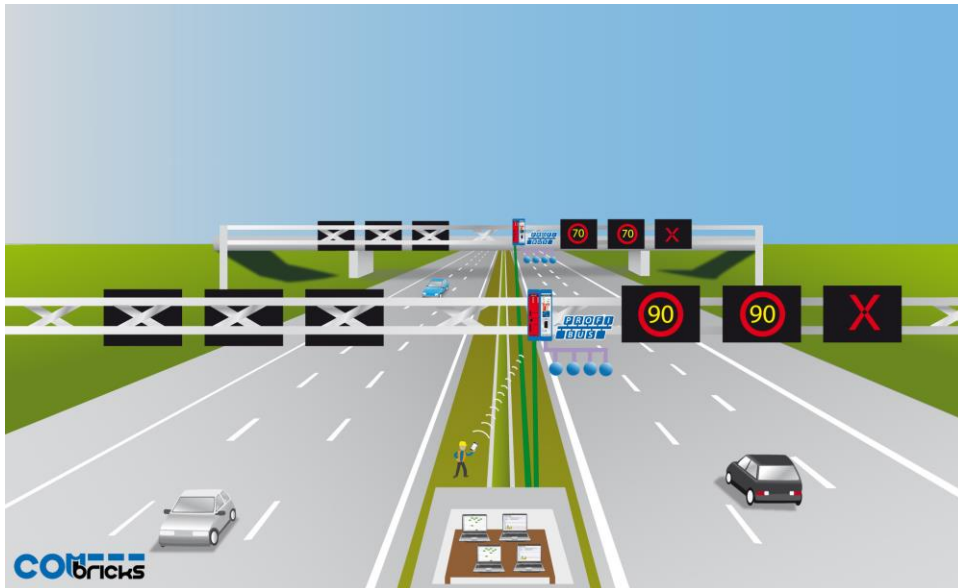

Fig. 8 - Traffic control applications

1.5.10 Cranes

Many harbour cranes use PROFIBUS. These cranes are huge and sometimes hard to reach. The whole crane can be monitored remotely, which is especially useful if the crane is equipped with a WIFI connection.

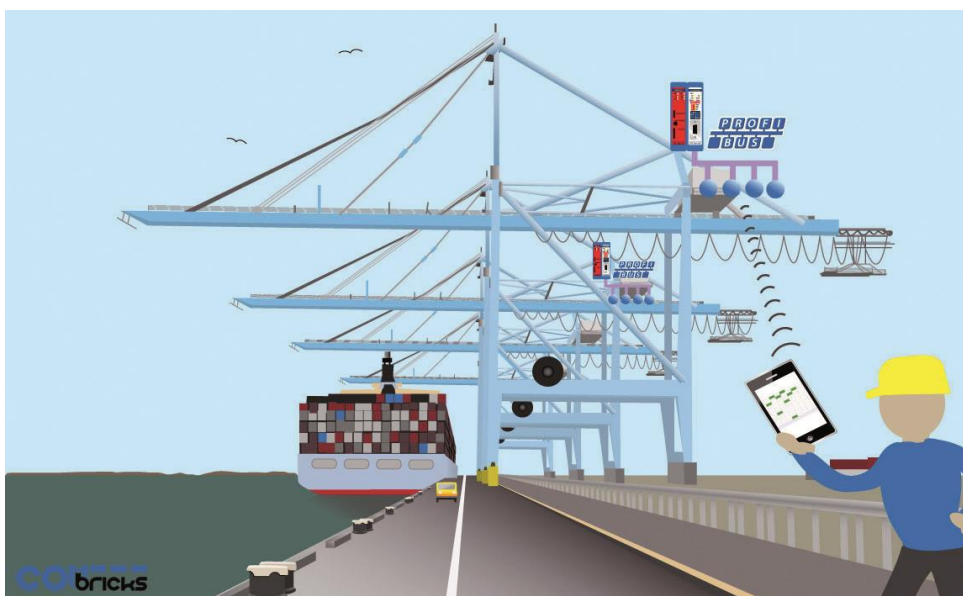

Fig. 9 - Crane applications

1.5.11 Other applications

- Cross border installations
- Water treatment
- Long commissioning and test cycles
- 24-7 service contracts

1.6 Output control

Relay- and digital output modules can be configured to respond directly to bus problems, such as bus voltage too low, retries, syncs, master lost, diagnostics, etc.

This offers a multitude of applications to directly and independently act on the machinery when the bus communication becomes unreliable. Especially when safety, human lives or the environment are at stake.

Power switches, hold switches, indicators, backup systems and LED towers are a few examples of machine parts that can be hooked up to the relays. ComBricks is the only monitoring product that has the capability to respond directly on the hardware with multiple relays.

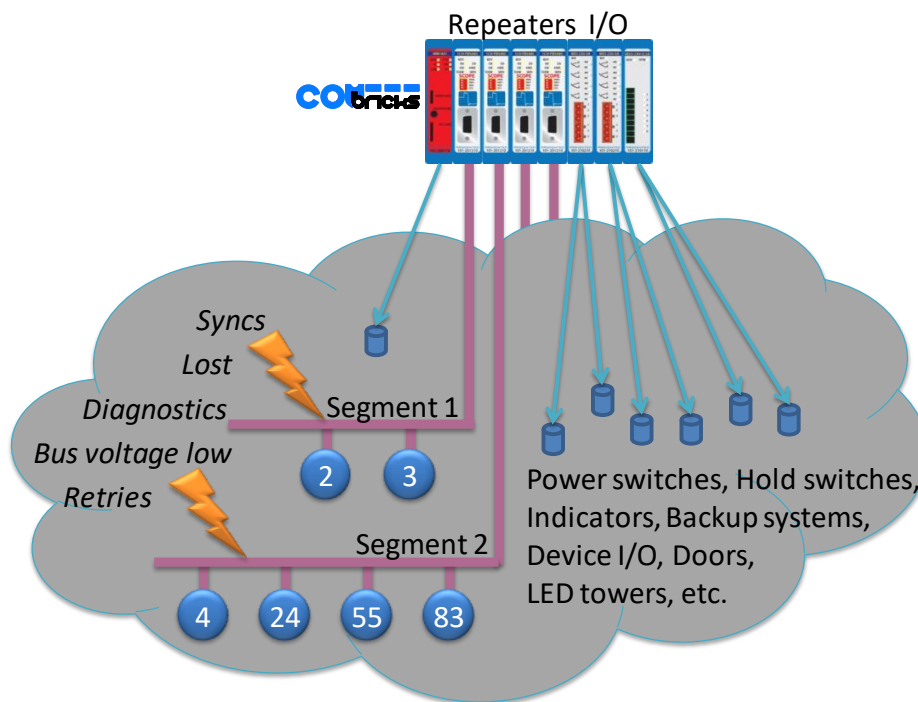

Fig. 10 - Output control

- The Head Station already contains 1 relay.
- The relays can also be configured to be switched manually or on time.

1.7 CommDTM

The FREE ComBricks CommDTM offers FDT 1.2 based asset management tools a powerful Ethernet pass-through to access PROFIBUS devices which are connected on ComBricks repeater modules.

Up to firmware version 1.301, the internal DP-V1 class 2 masters are able to drive 2 out of 4 networks. When a CommDTM connection is closed, the user can enter another network. The 2 active networks are managed by 1 or 2 PC Ethernet connections. Since version 1.301 this has changed to one master. The other master is used for the diagnostic slave Master (see 4.4 and 4.14).

The CommDTM provides the same auto baudrate detection facilities as the famous ProfiCaptain. It detects all busparameters before it goes online. An available master address is required.

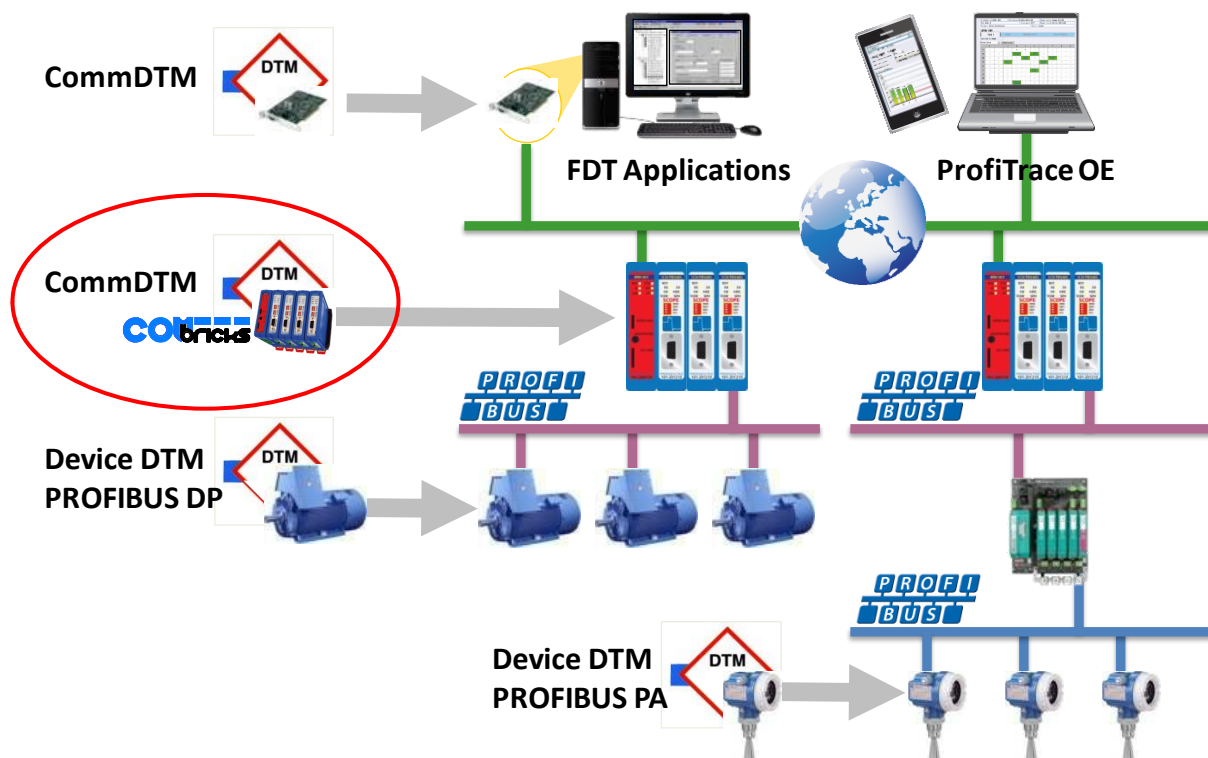

Fig. 11 - CommDTM structure

2 Quick start

2.1 Quick start checklist

This checklist lists all the steps to a quick usage of ComBricks.

- STEP 1:** Provide the Head Station with the latest firmware. (7)
- STEP 2:** Prepare the backplane with the amount of required backplane units. (2.2)
- STEP 3:** Click the assembled backplane on the DIN-rail. (2.2)
- STEP 4:** Insert the Head Station in the most left slot. (2.3)
- STEP 5:** Insert the other modules in the remaining slots. (2.3)
- STEP 6:** Configure the repeater modules to their appropriate networks. (2.4)
- STEP 7:** Wire the repeater modules with PROFIBUS cables. (2.5)
- STEP 8:** Power the Head Station. (2.6)

ComBricks units with Head Stations type 1A are now operational and no further steps have to be taken. For type 1B and 1C Head Stations proceed with the next steps.

- STEP 9:** Insert an Ethernet cable in the Head Station.
- STEP 10:** Set the IP address to the required value. (2.7 + 2.8)

ComBricks units with Head Stations type 1B and 1C are now operational, ProfiTrace OE is autonomously logging PROFIBUS events. After these basic steps ComBricks can be further configured through the web server.

- STEP 11:** Checking the modules and administrative info in the web server. (2.9)
- STEP 12:** Testing ProfiTrace OE on the PROFIBUS installation. (2.10)

2.2 Prepare the backplane

Click the fixed backplane on the DIN-rail and add additional backplane units to the right side if required (see **Paragraph 3.3** and **3.4**).

2.3 Insert modules

Insert the required modules in the slots of the fixed backplane (see **Paragraph 3.6**). The Head Station with the red front plate should be placed in the most left slot (with the large connector). Place the other modules in the remaining slots. The slots have a polarity and can only be inserted one way.

2.4 Configure the repeater modules

Configure the repeater modules to their appropriate networks. This can be done with the dipswitches located at the front of the module (see **Paragraph 3.10.1**) or with the software settings in the web server (see **Paragraph 4.6**).

2.5 Wire the repeater modules

Connect the PROFIBUS cables to the repeater modules (see **Paragraph 3.11**).

2.6 Power the Head Station

Provide a 24 VDC power supply to the Head Station through one of its 2 power connectors (see **Paragraph 3.8**).

2.7 Customizing the IP number through the web server

The default IP address of the Head Station is **192.168.1.254**. Follow the steps below to customize the IP address of the Head Station:

- STEP 1:** Insert an Ethernet cable in the Head Station which is connected to the enterprise LAN or directly to the PC.
- STEP 2:** Make sure the IP address of your PC is on the same subnet as the switch (192.168.1.xxx)
- STEP 3:** Open your web browser and enter 192.168.1.254 in the address field. This is default IP address of the ComBricks.
- STEP 4:** The web server of the ComBricks will appear.
- STEP 5:** Click in the menu on the left on "IP config".
- STEP 6:** Update the IP settings and confirm it by clicking on "Save" (see Fig. 12).
- STEP 7:** The web page will now reload with the new IP address.

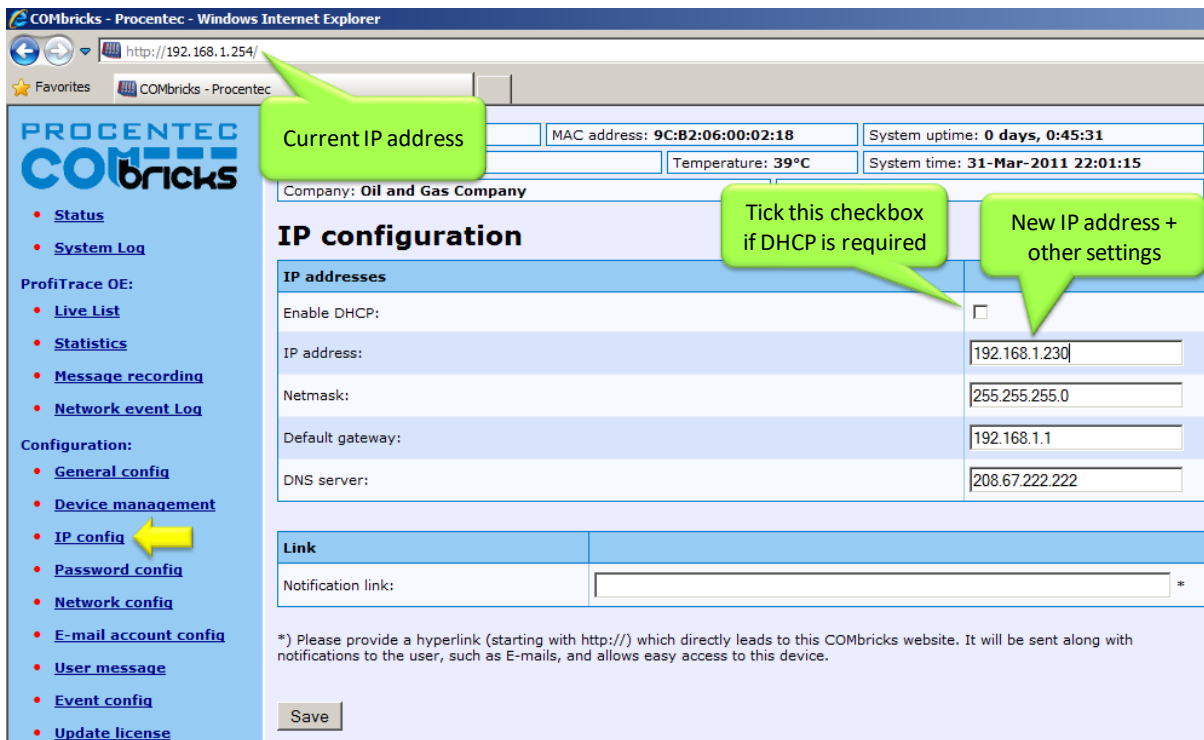

Fig. 12 - Customizing the IP address in the web server

The Notification link name is included in the event emails so that the user can directly jump to the specific ComBricks unit without knowing its local IP number. An example is: `www.boiler5.oag.com`. The router of the network or the internet server has to reroute this name to an IP number.

2.8 Customizing the IP number through the Discovery Tool

The ComBricks Discovery Tool can be downloaded from www.ComBricks.com.

After start-up all the available ComBricks units can be discovered and directly customized with the required IP address (see **Fig. 13**).

The Discovery Tool works on an enterprise LAN, WLAN and with a direct cable between ComBricks and PC.

If you are not sure which ComBricks you are customizing, the LEDs can be flashed with a button in the Discovery tool (flashing). The LEDs will blink for 5 seconds to give the user a visual confirmation.

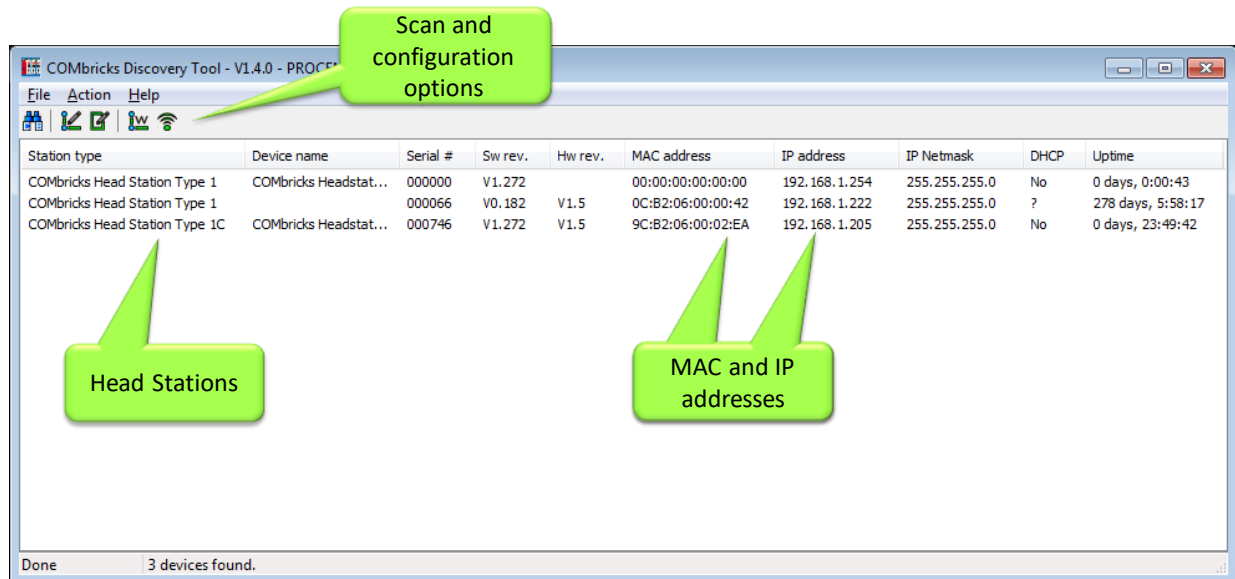

Fig. 13 - ComBricks Discovery Tool



It is recommended to have only one network interface connection active (only wireless or only wired). In some cases the Discovery tool does not list all the ComBricks units when multiple network interfaces are active.

2.9 Checking the modules and the administrative info in the web server

After customizing the IP address, the modules can be checked in the web server. Click on "Status" to see an overview of the available modules and their respective description + version numbers (see **Fig. 14**).

Modules can be inserted and removed during operation. A change in hardware should be directly visible in the Status screen.

On the top of the screen the administrative info is also visible (see **Fig. 14**). If the administrative information has to be altered, it can be done by clicking on "General config".

On the bottom of the screen the connected clients with this ComBricks are displayed.

All connections are listed here:

- Web connections
- FTP connections
- ComMDTM connections
- Telnet connections
- ProfiTrace Streaming connections

The screenshot shows the Procentec ComBricks web interface. The top navigation bar includes 'Status' (highlighted with a yellow arrow) and 'System log'. The main content area is titled 'Status' and contains several sections:

- Administrative Info:** IP address: 192.168.1.225, MAC address: 9C:B2:06:00:02:5C, System uptime: 0 days, 0:07:42, Site: Boiler 5, Temperature: 30°C, System time: 6-Dec-2011 11:18:37, Company: Oil and Gas Company, Country: Netherlands.
- User message:** - 5 December 2011: Service on Wago remote I/O, - 6 December 2011: Replaced plug on Siemens ET200S. Call John Doe in case of problems: +11 (222) 56882312.
- Inserted modules in the system:** A table with columns Slot, Status, Module, Serial #, and Hw Rev.
- Connected clients:** A table with columns IP address and Service.

Green callout boxes highlight specific features: 'Remote information' points to the administrative info, 'Messages left by the user' points to the user message section, 'Inserted modules in the system' points to the module table, and 'Connected PCs and other communication devices' points to the connected clients table.

Slot	Status	Module	Serial #	Hw Rev	
0	OK	Head Station Type 1C	PROCENTEC	000604	V1.5
1	OK	2 Channel RS485 Repeater Type 1	PROCENTEC	000655	V1.6
2	OK	2 Channel RS485 Repeater Type 1	PROCENTEC	000593	V1.6

Connected clients	Service
192.168.1.11	WEB (port 80)
192.168.1.19	WEB (port 80)
192.168.1.25	WEB (port 80)
192.168.1.44	WEB (port 80)

Fig. 14 - Overview of the available modules

2.10 Testing ProfiTrace OE on the PROFIBUS installation

When the repeaters are wired to the PROFIBUS installation, ProfiTrace OE can be tested in the web server.

Click on "Live List" and the respective networks. A Live List with devices should appear (see **Fig. 15**).

The screenshot shows the COMbricks web interface. The top navigation bar includes the logo and a menu with items like Status, System log, and ProfiTrace OE. The ProfiTrace OE section has a yellow arrow pointing to the 'Live list' link. The main content area shows the 'Live list' for 'Tank 1'. A green callout bubble points to the 'Tank 1' tab and says 'Monitoring 4 networks'. Another green callout bubble points to the table and says 'Similar Live List as ProfiTrace 2'. The table displays device addresses and model names for 89 addresses.

	0	1	2	3	4	5	6	7	8	9
0	0	1	2	3	4	5	6	7	8	9
10	10	11	12	Heidenhain Encoder	14	VM10 NORGREN	16	17	18	19
20	20	21	22	23	750-333 WAGO	25	26	GPL-DT4 LGIS	28	29
30	30	31	750-333 WAGO	33	34	35	ET200S SIEMENS	37	38	39
40	40	41	42	43	44	45	46	47	48	49
50	50	51	52	53	54	BPS34 LEUZE	56	57	58	59
60	60	61	62	63	64	65	66	67	68	69
70	70	71	72	73	74	75	76	77	78	79
80	80	81	82	ILBPBA14AG PHOENIX	84	85	86	87	88	89

Fig. 15 - ProfiTrace OE Live List

See **Chapter 5** for more information on how to use ProfiTrace OE.

2.11 Resetting the Head Station

By means of the "Menu Nav" switch on the front of the Head Station (see **Fig. 16**), ComBricks can be reset, warm started or loaded with configuration data. Please follow the procedure described in **Paragraph 6.5**.

The following selections are possible:

- Read settings from SD card
- Save settings on SD card
- Clear password
- **Reset to factory defaults**
- Warm start

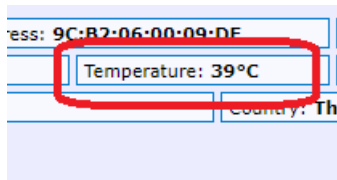

Fig. 16 - Menu-switch

3 Installation instructions

3.1 Location

ComBricks can be installed everywhere in a non-hazardous area that complies with IP 20 (DIN 40 050) and a specified maximum operating temperature of +60 °Celsius. Avoid placing two ComBricks sets above each other; the generated heat of the lower set will add to the ambient temperature for the upper set. Furthermore, make sure the generated heat can disperse by using forced ventilation or active cabinet cooling.



Please note: the temperature displayed in the webserver is the temperature *inside* the Head Station, not the ambient temperature.

3.2 Position

ComBricks can only be installed horizontally, with the cables pointing down. In this position the generated heat of the modules can escape through the grid in the top of the housing. It is also easier to read the status LEDs in the horizontal position.

3.3 Mounting and un-mounting backplane units

The backplane of the ComBricks has to be mounted on 35 mm DIN-rail with a minimum width of 50 mm to fit a fixed backplane for 2 modules.

Fig. 17 illustrates how to mount and dismount the backplane on and from the DIN-rail. For the un-mounting an appropriate screwdriver is required.

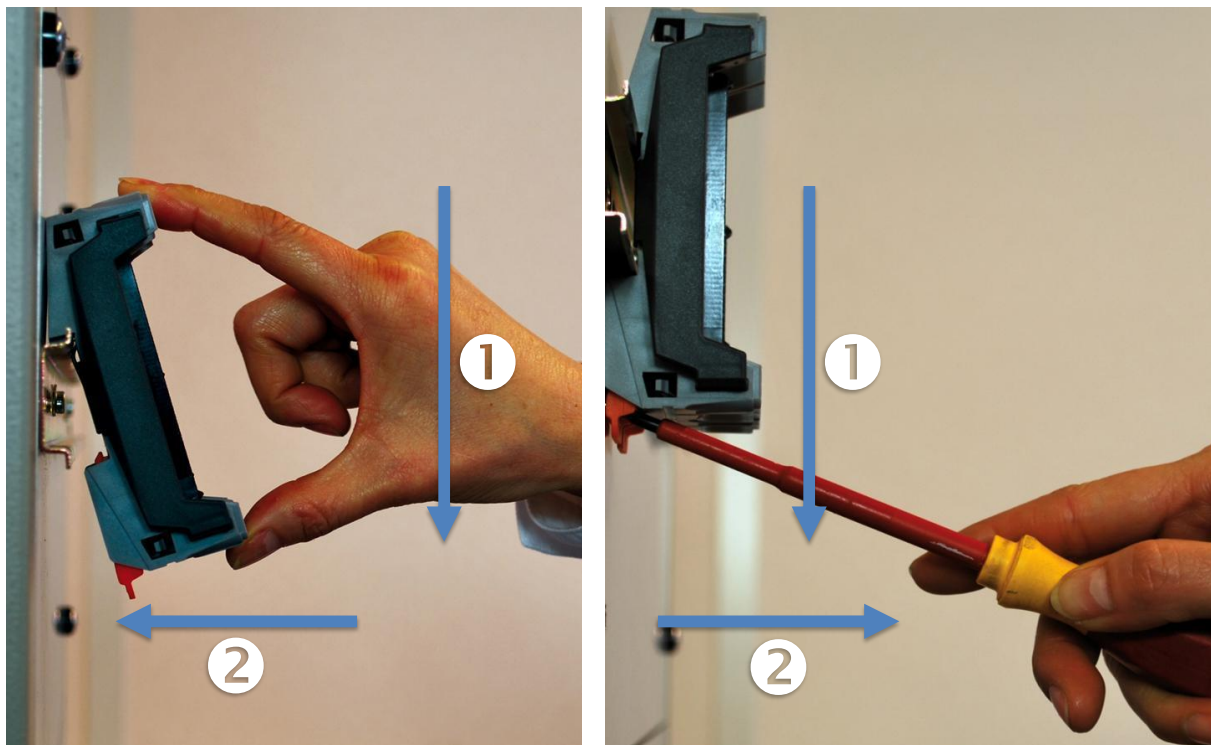

Fig. 17 - Mounting (pull-down + push)

Un-mounting (click tap + pull)

3.4 Adding backplane units

The additional backplane units as described in **Paragraph 3.3**. To merge them remove the plastic covers on the side of the backplane units that have to be merged. Push both backplane units together until no more movement is possible (see **Fig. 18**).



Do not add or remove backplane units while the backplane is powered!
This can cause serious damage to the ComBricks set.

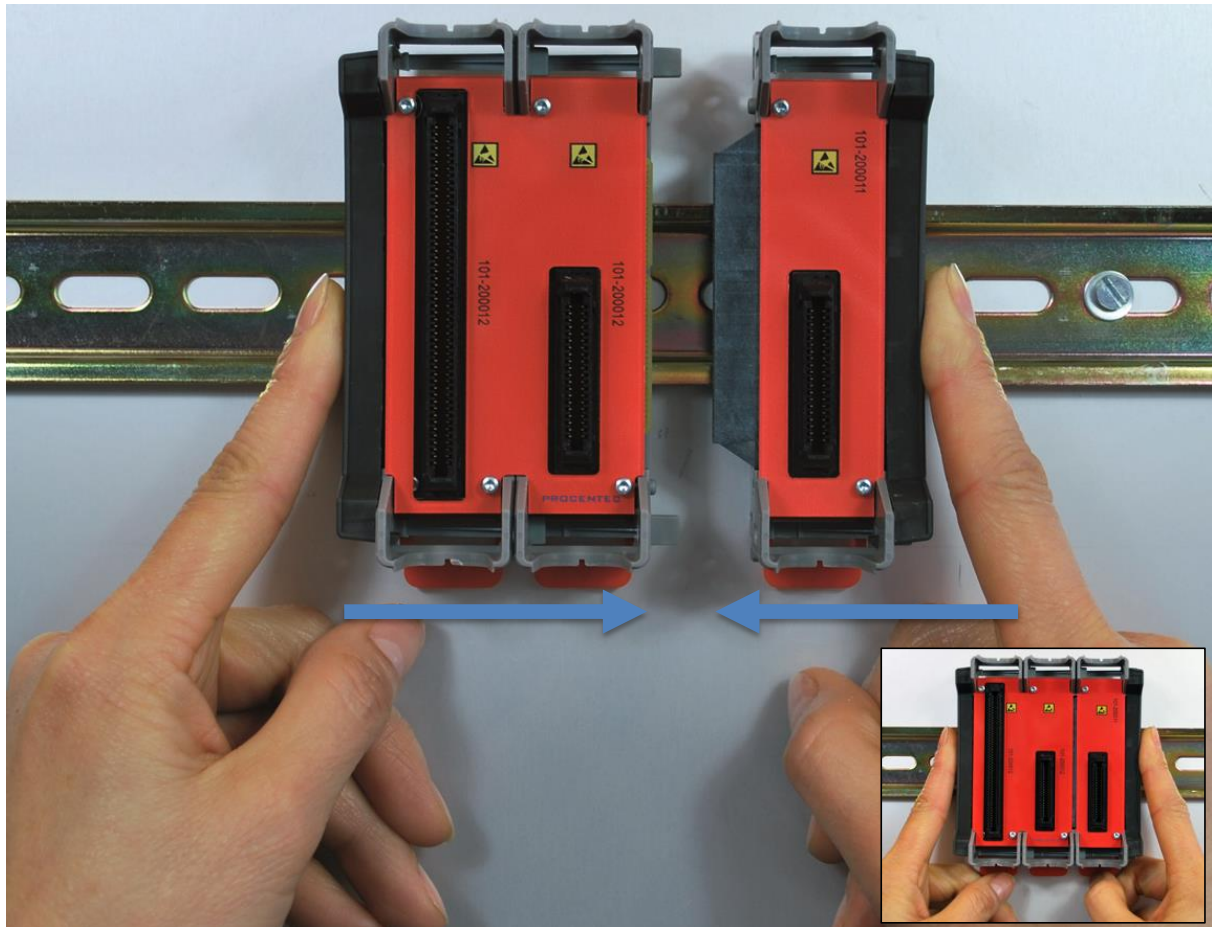

Fig. 18 - Adding backplane units

3.5 Detaching backplane units



Detaching backplane units is a delicate procedure that should be done according the description below and **Fig. 19** in order to prevent damages.



Do not add or remove backplane units while the backplane is powered!
This can cause serious damage to the ComBricks set.

- STEP 1:** Push the top arm down with a screwdriver and delicately pull the top of the backplane unit that has to be removed. The arm should now be unlocked.
- STEP 2:** Push the bottom arm down with a screwdriver and delicately slide the bottom of the backplane that has to be removed. The arm should now be unlocked.
- STEP 3:** Slide the backplane unit away from the section that remains.

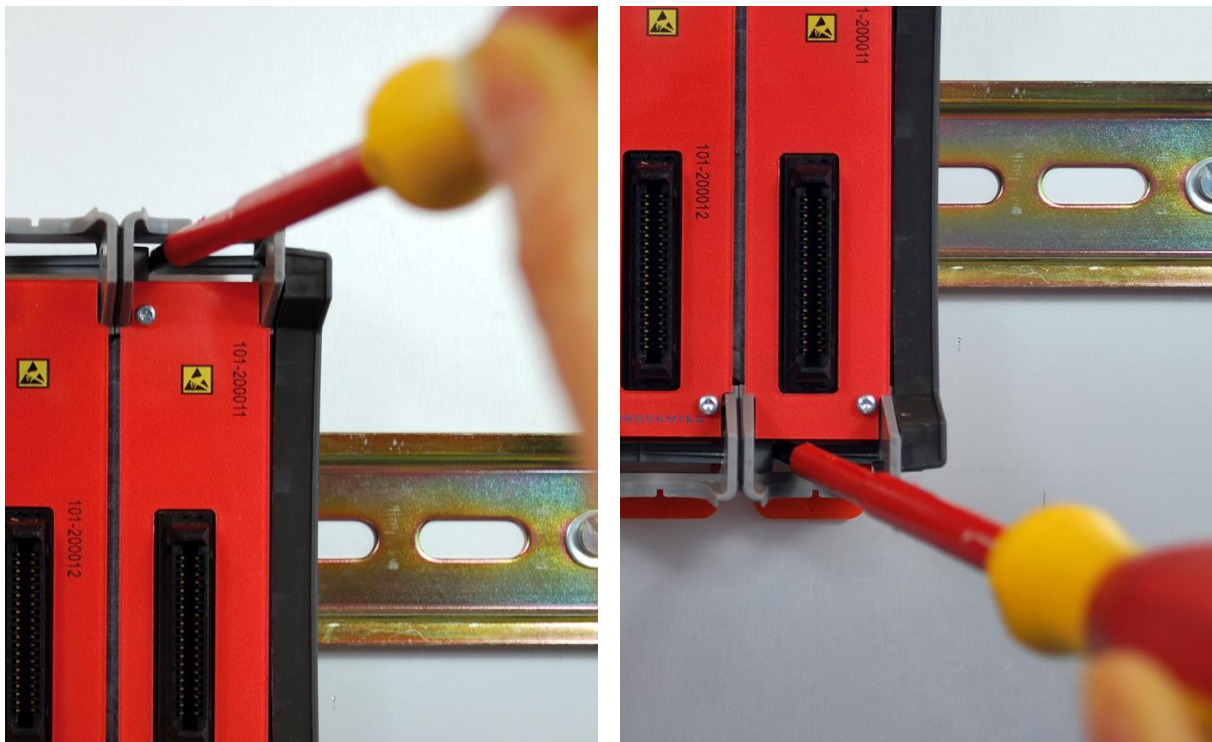

Fig. 19 - Detaching backplane units

3.6 Inserting modules

Push and click the modules in the slots of the backplane (see **Fig. 20**).

The Head Station (with the red front plate) should be placed in the most left slot (with the largest connector) and the other modules in the remaining slots.

When the modules are inserted the correct way, a sharp clicking sound should be heard during the push.



Modules can be inserted during operation.



The slots have a polarity and fit only one way.

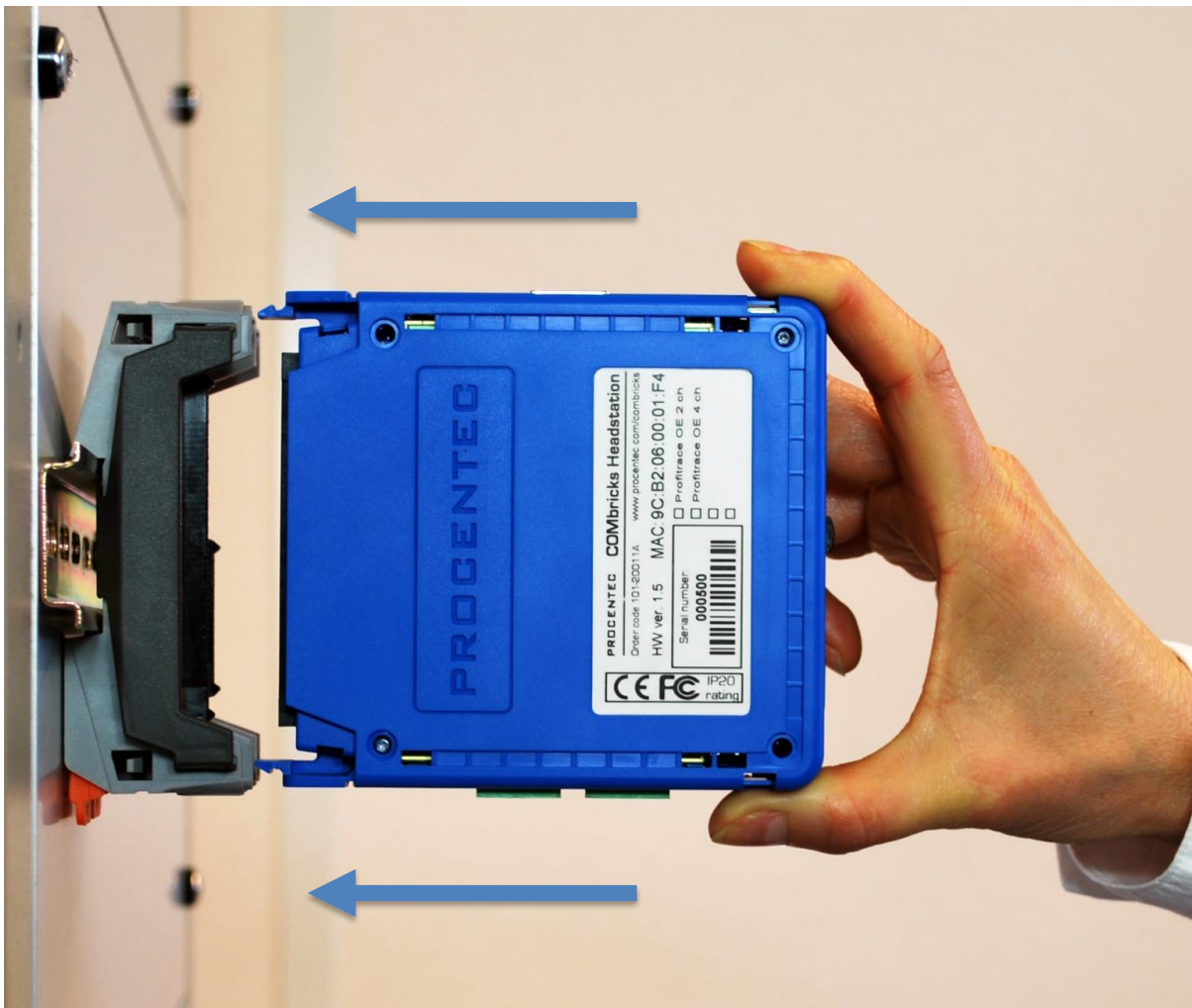

Fig. 20 - Inserting modules

3.7 Removing modules

To remove a module press the keys on both sides of the module (this has to be done with 2 hands). When both keys are pressed, pull the module out of the slot (see **Fig. 21**).

Modules can be removed during operation.



1 Slot between 2 modules can remain empty when modules are removed during operation. Modules at the end of the backplane can always be removed (1-by-1).

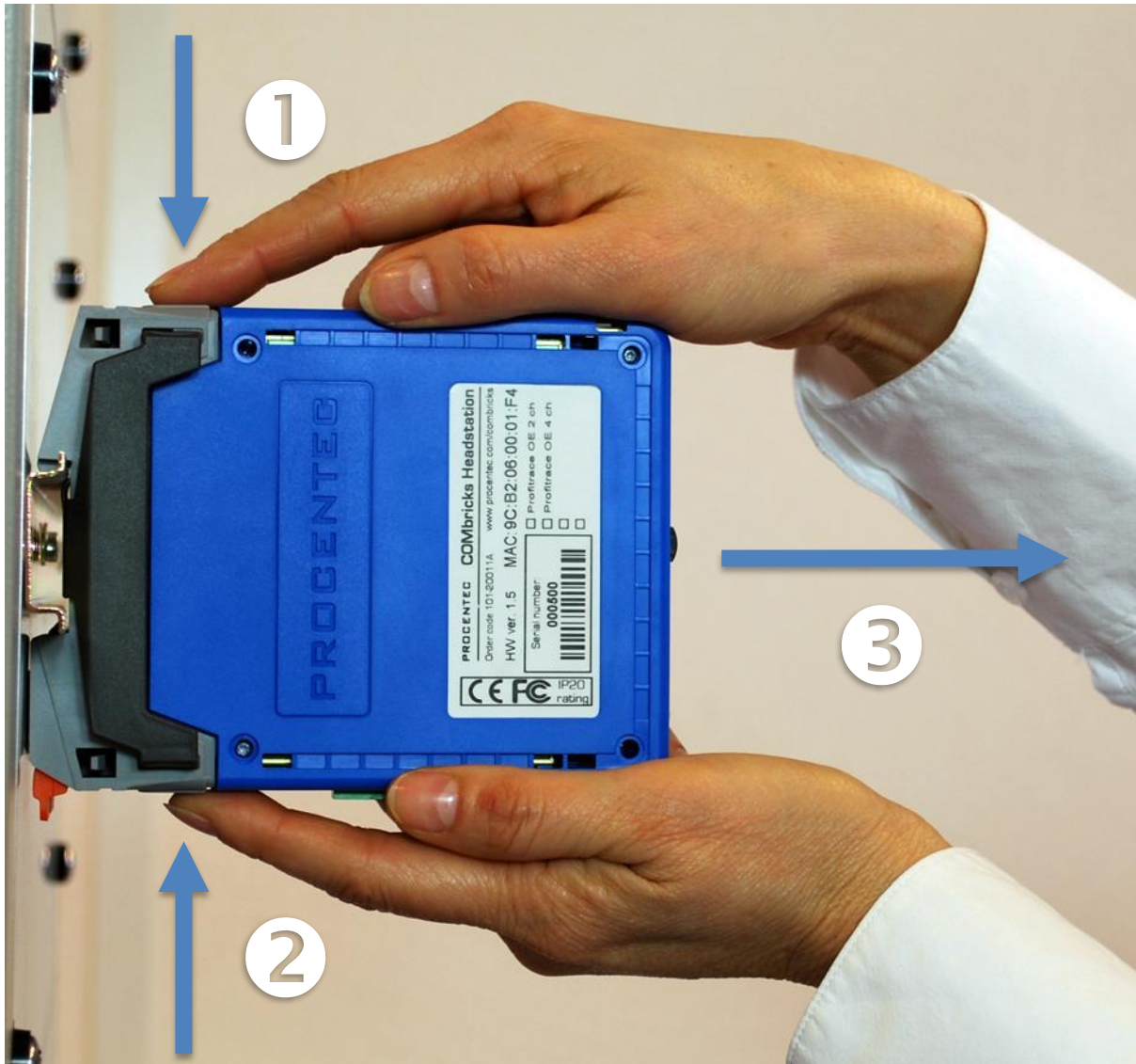

Fig. 21 - Removing modules

3.8 Wiring Ethernet

The Ethernet connector is located on the top-side of the Head Station. The connector contains LEDs that indicate linkup (green) and reception of data (orange).

It is recommended to use a cable/RJ45 plug with grounding/foil due to the nature of industrial applications.

The Ethernet interface complies with standard Ethernet guidelines. The maximum cable length from ComBricks to switch/device is 100 meter.

The MAC address is printed on the side of the Head Station.

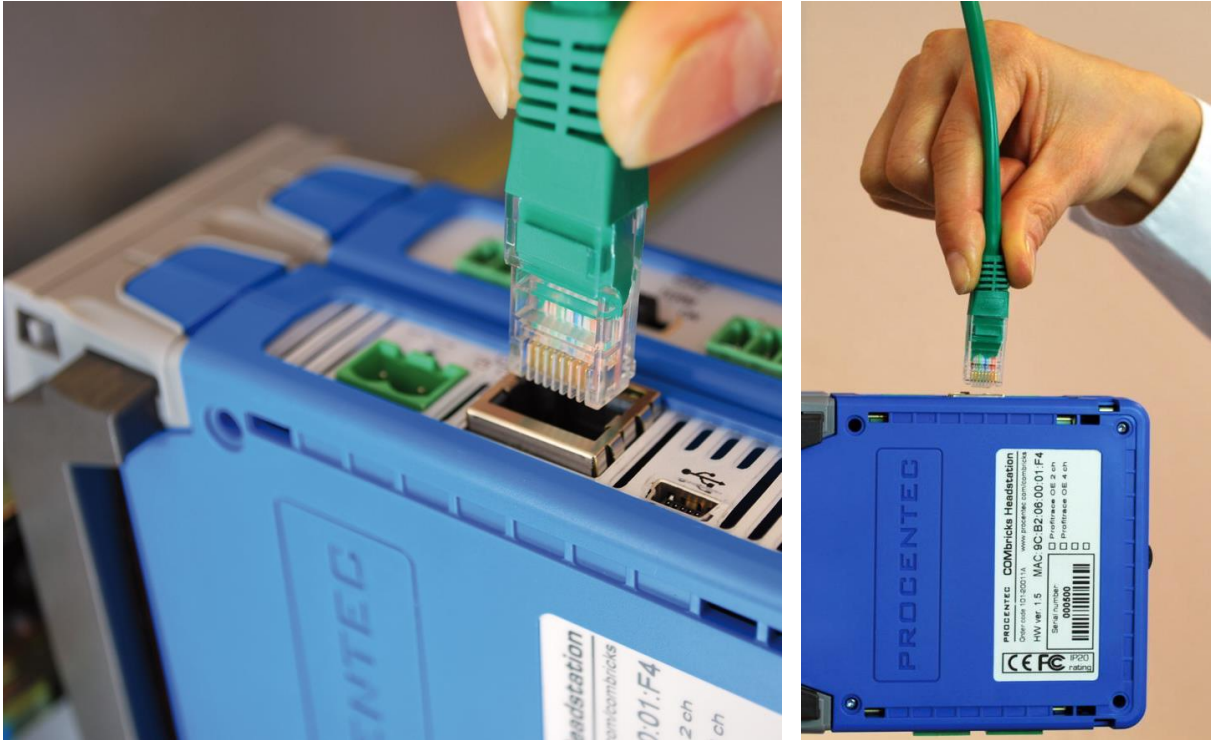

Fig. 22 - Wiring Ethernet

3.9 Power Supply

The Head Station contains two 3-pin screw type power connectors on the bottom. If power redundancy is NOT required, either one can be used.

The layout is as follows (when the wires are pointing down):

1 = - (left)

2 = + (middle)

3 = **SH** (right)

The power supply must comply with the following specifications:

- Voltage: 10.8 .. 26.4 VDC
- Current: Min. 800 mA
- Wire diameter: < 2.5 mm²

3.9.1 Procedure

To connect the 24 VDC supply to the 3-pin screw-type terminal, proceed as follows:

STEP 1: Strip the insulation of the conductors of the 24 VDC power supply.

STEP 2: Secure the conductors in the screw-type terminal.

STEP 3: Insert the entire connector block in the power socket (see **Fig. 23**).

To connect the power supply a 3 mm screwdriver is required.

3.9.2 Testing and commissioning

If the power is switched ON it can be diagnosed by the following indicator procedure:

- All LEDs on the Head Station should be shortly ON.
- The RDY LED should be shortly Blinking.
- The SD LED should be ON (if an SD card is inserted).
- The RDY LED should be ON (also on other inserted Modules).

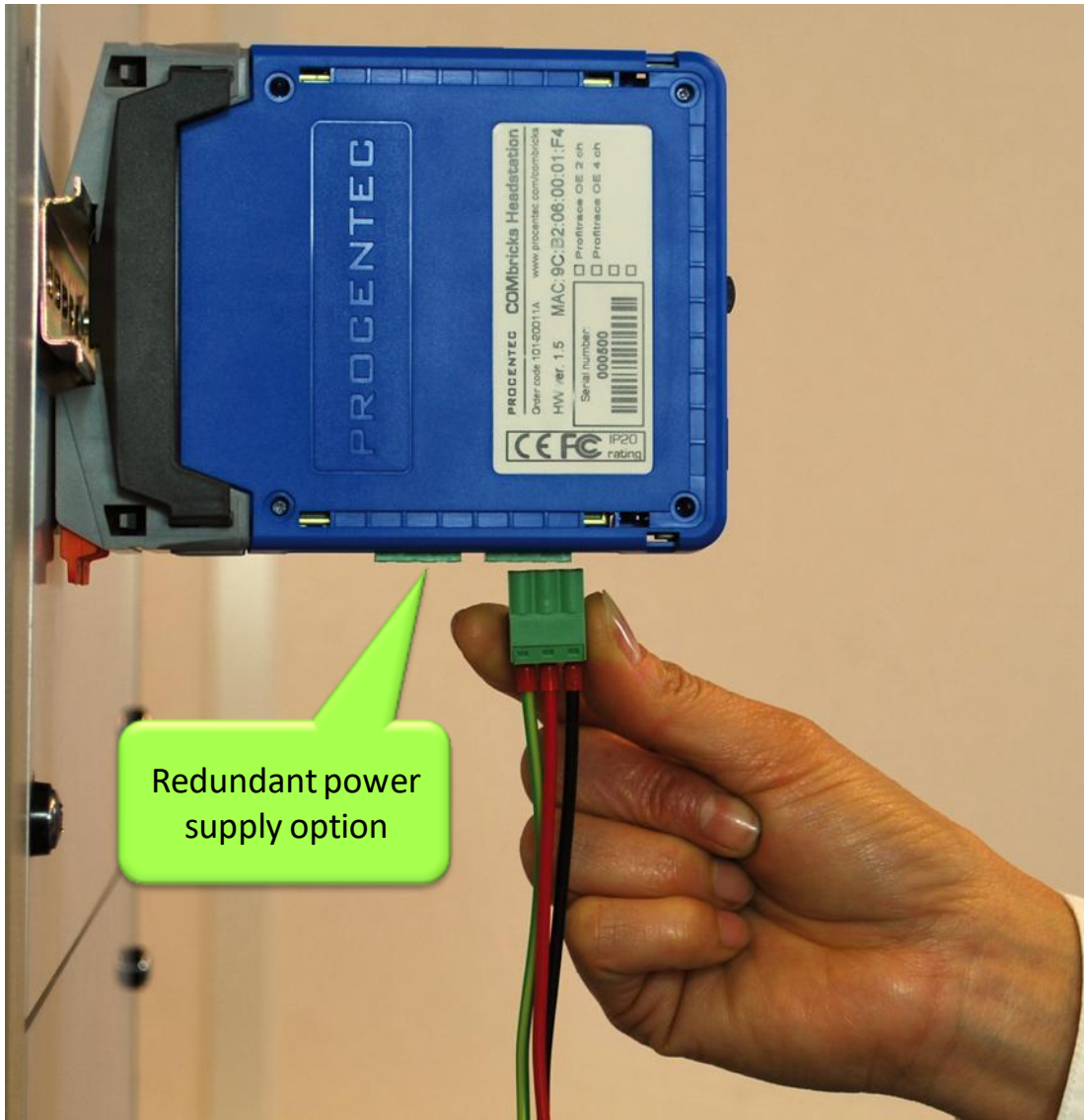

Fig. 23 - Head Station power supply

3.10 Configuring repeater modules

The repeaters can be configured using the dipswitches located at the front of the module or the web server.

3.10.1 Customizing the PROFIBUS network (NW0/NW1)

Set these dipswitches to the following positions to customize a network number for a specific PROFIBUS network.

NW0	NW1	Network
LEFT	LEFT	1
RIGHT	LEFT	2
LEFT	RIGHT	3
RIGHT	RIGHT	4



When software settings are preferred these dipswitches do not have to be set.

3.10.2 Redundancy (RED)

Set this dipswitch to enable the redundancy group for the channel.

RED	Redundancy
LEFT	OFF
RIGHT	ON



When software settings are preferred this dipswitch does not have to be set.

3.10.3 Hardware or software settings (H/S)

Set this switch to enable hardware (dipswitches) or software settings.

H/S	Settings
LEFT	Hardware
RIGHT	Software



When software is enabled, all switch settings are overruled. The settings are saved in the internal memory of the Head Station.

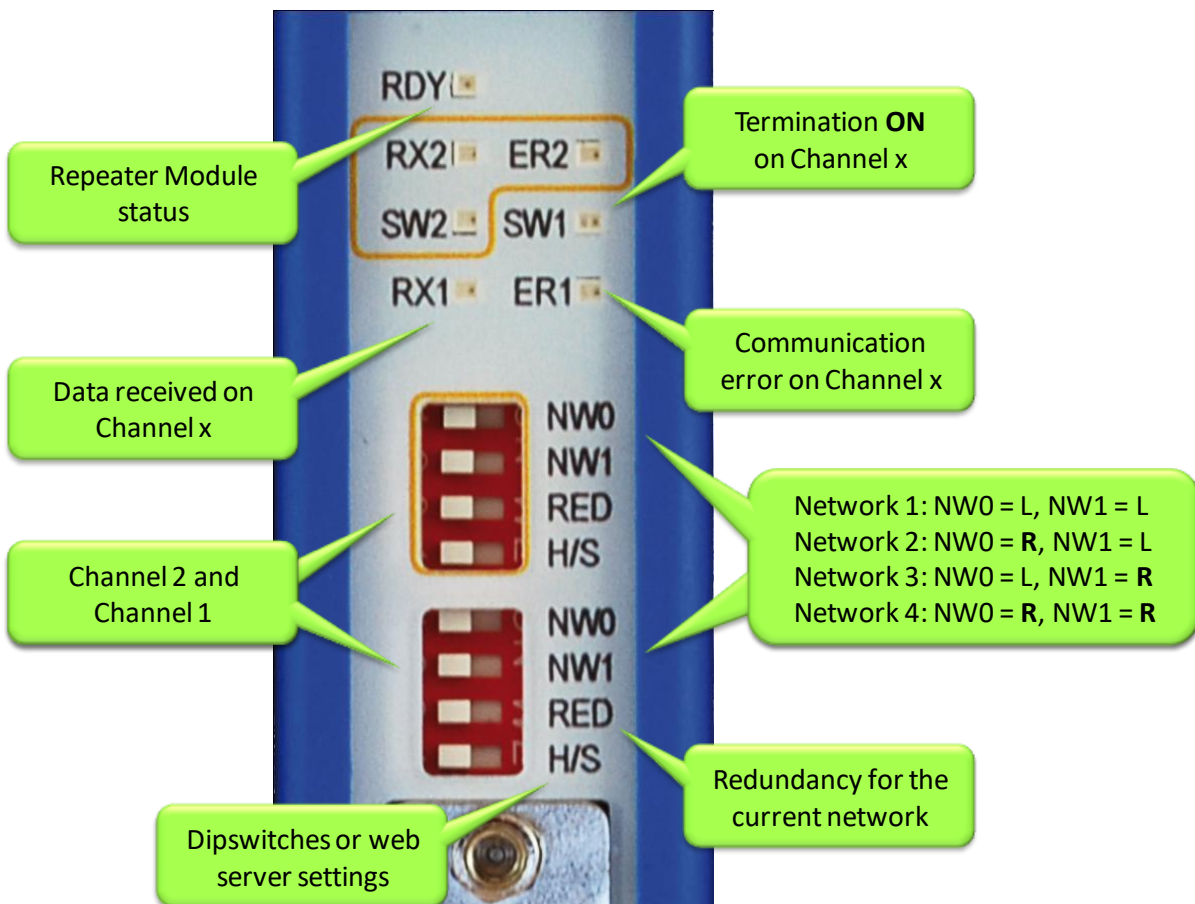

Fig. 24 - Dipswitches and LEDs of the repeaters

3.11 Wiring repeater modules

The PROFIBUS cable should be wired to the repeaters according to the PROFIBUS guidelines with suitable cable for the application you are using.

Regular and SCOPE repeater modules are equipped with screw terminals and a DB9 connector for the bus connection. Both are linked with each other, but it is not recommended to use them both¹.

Fig. 25 illustrates 4 recommended connection topologies for the repeater modules.

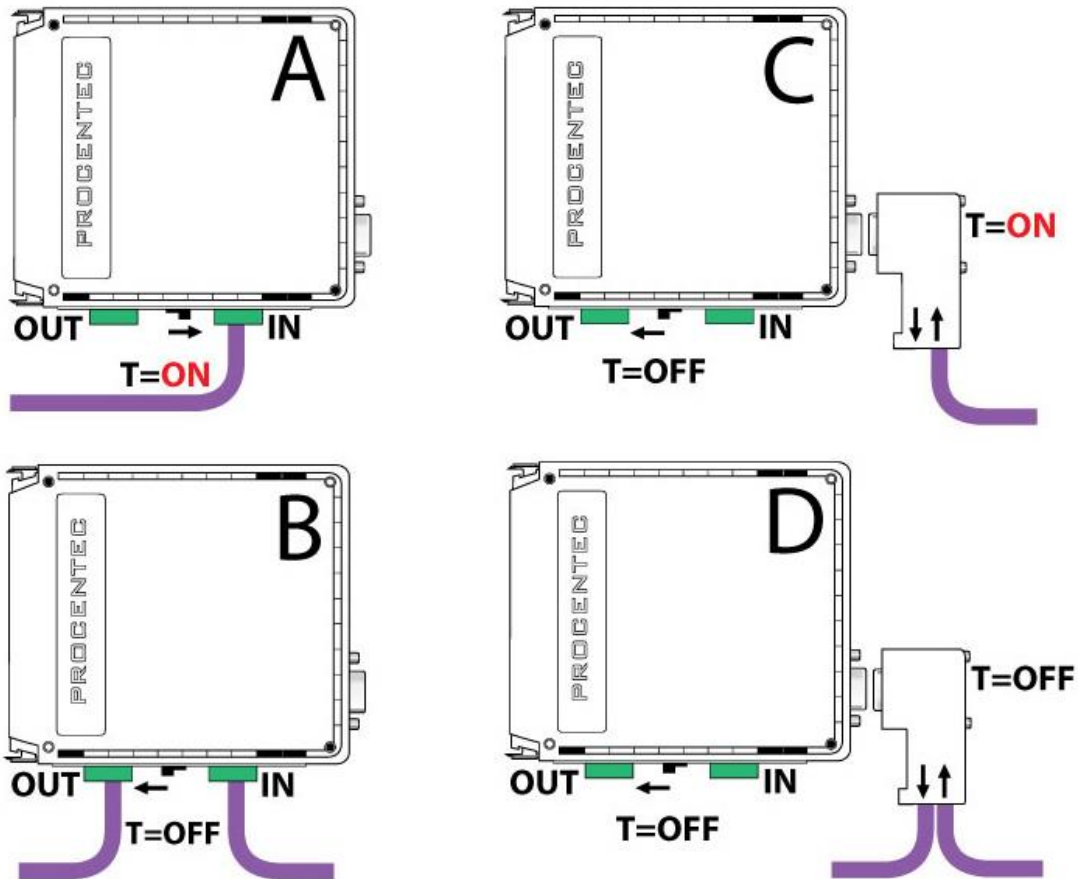

Fig. 25 - Repeater connection topologies (old modules only)

¹ Because of the PROFIBUS spur lines limitations it is not recommended to use the screw terminal simultaneously with the DB9 connector.

3.11.1 Screw terminals

- With a 1 channel repeater module, the channel is marked CH1.
- With a 2 channel repeater module, the channels are marked CH1 and CH2.



Since March 2014 the **1 Channel**, **2 Channel** and **Scope Repeater** modules are fitted with new, more robust screw terminals.

Old modules: The channels (CHx) have 2 screw terminals (IN and OUT, for the bus connection) and a termination switch.

Always use the 'IN' connector when the repeater module is the first or last on the segment. The termination should be set to ON (see **Fig. 25 - configuration A**).

New modules: The channels have 1 screw terminal and a termination switch. In most cases, the channel starts here so the termination must be set to 'ON'. If the channel is not the beginning, use the DB9 connector, see **paragraph 3.11.2**. Alternatively, use the dual ground clip (supplied with the new models) to install two cables in one screw terminal, see **Fig. 26**.

Only in configuration A of **Fig. 25** the on-board termination should be set to ON. In configurations B and D the repeater module is in the middle of the segment (OFF).

Pin layout of the screw terminals

Pin "A": Green wire

Pin "B": Red wire

Pin "SH": Cable shielding OR

Pin "I": Cable shielding



Fig. 26 - Use the Dual Ground Clip to connect two PROFIBUS cables in one screw terminal

3.11.2 DB9 connector

The bottom channel (CH1) is additionally equipped with a DB9 connector to offer an alternative connector for standard 9-pin PROFIBUS plugs (1-on-1 with the screw terminals).

When the DB9 connector is utilized and located at the end of the segment, it is recommended to use the termination on the DB9 connector and NOT on the repeater module (see **Fig. 25 - configuration C**)²



To connect the PROFIBUS cable to the repeater modules (screw terminals) a 2.5 mm screwdriver (max. 0.4 mm) is required.

3.11.3 Testing and commissioning

If the channel recognizes valid PROFIBUS messages from 1 or more connected devices, the RX LED of this channel should be blinking and ER should be OFF.

When the termination of a specific channels is set to ON, the SWx LED should be ON.

² The plug is the best place to activate the termination! When you remove the connector from the module you still have the termination in the plug which is attached to the bus cable. It is true that the termination is not powered by 5V (which is always required), but better an unpowered termination than nothing at all.

4 Web server

To access the web server of ComBricks, open your web browser and enter the IP address that has been setup (after purchase or reset the default IP address is [192.168.1.254](#)). In the Discovery Tool you can find a button to access the web server with the default Windows browser.



If a User password has been setup a screen will appear to login first in order to access the web server. If only the Administrator password has been setup it is not necessary to login to directly, but when settings are altered you must be logged in (See **Paragraph 4.9**).



Some web pages described in this manual are only accessible with certain Head Station types, licenses or firmware versions.

After the web page has been loaded, the pages of the web server can be browsed by clicking on the items in the menu on the left side of the screen. The next paragraphs will explain the primary web server pages.



The web server can handle 20 simultaneous client connections. When all 20 are utilized, the connection with the ComBricks could become relatively slow.



The minimum version requirements for Web browsers are:

- Firefox 2.0 (24 October 2006)
- Internet Explorer 6.0 (27 Augustus 2001)
- Google Chrome 1.0 (24 April 2009)

4.1 Status

Head Stations: **1A, 1B, 1C**
Firmware: **V1.140 and higher**
Login: **User or Administrator**

The 'Status' screen is the first web page that appears when the web server is accessed. This page gives an overview of the available modules and their respective description + version numbers (see **Fig. 27**).

Modules can be inserted and removed during operation. Changes in hardware should be directly visible in the Status screen.

The 'User message' with custom messages/info is also displayed here (see **Fig. 27**).

On the top of the screen the network and site info can be inspected (see **Fig. 27**).

On the bottom of the screen the connected clients with this ComBricks are visible (see **Fig. 27**).

The screenshot shows the PROCENTEC COMbricks Status screen. At the top, there are fields for IP address (192.168.1.225), MAC address (9C:B2:06:00:02:5C), System uptime (0 days, 0:07:42), Site (Boiler 5), Temperature (30°C), System time (6-Dec-2011 11:18:37), Company (Oil and Gas Company), and Country (Netherlands). The main content area is titled 'Status' and includes a 'User message' section with two entries: '- 5 December 2011: Service on Wago remote I/O' and '- 6 December 2011: Replaced plug on Siemens ET200S'. Below this is a table of installed modules with columns for Slot, Status, Module, Serial #, and Hw Rev. The table lists three modules: Slot 0 (Head Station Type 1C), Slot 1 (2 Channel RS485 Repeater Type 1), and Slot 2 (2 Channel RS485 Repeater Type 1). At the bottom, there is a 'Connected clients' table with columns for IP address and Service. The table lists four clients with IP addresses 192.168.1.11, 192.168.1.19, 192.168.1.25, and 192.168.1.44, all using WEB (port 80) service. A sidebar on the left contains navigation links for Status, System log, and various configuration options.

Slot	Status	Module	Serial #	Hw Rev
0	OK	Head Station Type 1C	PROCENTEC	000604 V1.5
1	OK	2 Channel RS485 Repeater Type 1	PROCENTEC	000655 V1.6
2	OK	2 Channel RS485 Repeater Type 1	PROCENTEC	000593 V1.6

Connected clients	Service
192.168.1.11	WEB (port 80)
192.168.1.19	WEB (port 80)
192.168.1.25	WEB (port 80)
192.168.1.44	WEB (port 80)

Fig. 27 - Status screen

Most of the module types offer their specific status screen. Click on the link (name in the module column) and the respective web page will be displayed (see **Fig. 28**).



- [Status](#) 
- [System log](#)

ProfiTrace OE:

- [Live list](#)
- [Statistics](#)
- [Channel list](#)
- [Message recording](#)
- [Network event log](#)
- [Event config](#)
- [Tag-name config](#)

Special modules:

- [Oscilloscope images](#)
- [Oscilloscope errors](#)
- [Barqraph images](#)
- [PA measurements](#)
- [Oscilloscope config](#)

Configuration:

- [General config](#)
- [Network config](#)
- [IP config](#)
- [Password config](#)
- [E-mail account config](#)
- [Device management](#)

IP address: 192.168.1.250	MAC address: 9C:B2:06:00:04:6A	System uptime: 0 days, 1:25:49
Site: PTK-J	Temperature: 42°C	System time: 21-Mar-2013 15:20:29
Company: PROCENTEC		Country: The Netherlands

Head station status

Head station info	
Vendor:	PROCENTEC
Module type:	Head Station Type 1C
Serial number:	001130
Software revision:	V1.274
Hardware revision:	V1.9
MAC address:	9C:B2:06:00:04:6A
IP address:	192.168.1.250
Device name:	Demo-COMbricks
Power supply 1:	● Connected
Power supply 2:	● Not connected
Micro SD-card present:	Yes
Micro SD-card capacity:	Total: 1.84 GB (free: 1.77 GB, used: 76.03 MB)
Current consumption (ref: 5.75V):	1.74A @ 5.67V
Temperature:	42°C
Uptime:	0 days, 1:25:49
Attached modules:	6
System status:	OK
I/O status:	OK

Power redundancy status

SD card status

Current consumed by the modules

Fig. 28 - Example of a module status

4.2 Channel list

Head Stations: **1A, 1B, 1C**
 Firmware: **V1.152 and higher**
 Login: **User or Administrator**

A helpful utility is the Channel list. This page visualizes a graphical overview of all stations in the network and to which network module they are connected. It is almost comparable with a logical topology scan (see Fig. 29).

The screenshot displays the 'Device channel list' interface. At the top, system information is shown: IP address: 192.168.1.205, MAC address: 9C:B2:06:00:02:EA, System uptime: 1 days, 1:20:53, Site: Tank 5, Temperature: 42°C, System time: 17-May-2013 10:22:03, Company: Oil and Gas Company, Country: The Netherlands.

The main section is titled 'Device channel list' and includes a note: 'Only the first 10 slots and their respective channels are displayed.' Below this are network filters: 'Display network 1: [checked]', 'Display network 2: [checked]', 'Display network 3: [checked]', 'Display network 4: [checked]'. There are also 'Reset Live list of network' buttons for each network.

The device list shows slots 0 through 8. Slot 0 is HEADSTA. Slots 1-7 are network modules (Nw 2) with various channels (ch 1, ch 2). Slot 8 is PWR-eA. Below the device list is a table of communicating devices with live list colors:

Nw 1:	Nw 1:	Nw 1:	Nw 2:	Nw 2:	Nw 2:	Nw 1:
3	83	34	71	78	21	102

Annotations in the image highlight: 'Show colour legend' (pointing to the 'Nw 2: 2' label), 'Network filters' (pointing to the network selection checkboxes), 'Inserted network modules and the available channels' (pointing to the device slots), and 'Communicating devices with Live List colours' (pointing to the table below).

Fig. 29 - Channel list

4.3 System log

Head Stations: **1A, 1B, 1C**
Firmware: **V1.140 and higher**
Login: **User or Administrator**

The system log saves ComBricks events. When this page is accessed all the ComBricks events are displayed. It can be downloaded as text file and cleared/deleted (see Fig. 30). You cannot change the system log in the web server.

The 'System log' is;

- **kept intact** after a power down and continues its logs after a power-up.
- **auto/live updating** when this screen is accessed.
- **saved** on the SD card.

The screenshot shows the COMbricks web interface in a Windows Internet Explorer browser. The address bar shows the URL http://192.168.1.230/. The page header includes system information: IP address: 192.168.1.230, MAC address: 9C:B2:06:00:02:18, System uptime: 0 days, 0:02:18, Site: Boiler 5, Temperature: 28°C, System time: 2-Apr-2011 16:29:41, Company: Oil and Gas Company, and Country: Alaska.

The main content area is titled "System log" and features a table of events. The table has columns for "#", "Date & Time", and "Message". The events are as follows:

#	Date & Time	Message
5	2-Apr-2011 16:28:18	Module added in slot 2: 2 Channel RS485 Repeater Type 1 (sn:200)
4	2-Apr-2011 16:28:10	Module removed from slot 2
3	2-Apr-2011 16:27:48	Module added in slot 2: 2 Channel RS485 Repeater Type 1 (sn:200)
2	2-Apr-2011 16:27:42	Module added in slot 1: 2 Channel RS485 Repeater Type 1 (sn:201)
1	2-Apr-2011 16:27:34	System startup (00)

Below the table are "Download" and "Clear" buttons, and a note: "Last update: 2-Apr-2011 16:29:41 (5 lines, 20 lines per page)".

The left sidebar contains a navigation menu with the following items: Status, System Log (highlighted with a yellow arrow), ProfiTrace OE: Live List, Statistics, Message recording, Network event Log, Configuration: General config, Device management, IP config, Password config, Network config, E-mail account config, User message, Event config, and Update license.

Callouts in the image point to the "System Log" menu item, the "Download and Clear functions" buttons, and the "System events" table.

Fig. 30 - System log

4.4 Diagnostic slave info

ComBricks can retrieve information from compatible ProfiHub Diagnostic slaves in the field. This is achieved by an internal master in the ComBricks Head Station. If this feature is set up correctly (see paragraph 4.14) and if a compatible ProfiHub has been automatically detected, the information of this ProfiHub Diagnostics slave is displayed as follows:

ProfiHub diagnostic slave info

ProfiHub B5+RD (Address: 5, Serial#: 2933) Clear selected device Show overview

Diagnostic slave info	
Last update:	24-Jan-2019 12:48:52
ProfiHub type and serial number:	ProfiHub B5+RD (Serial#: 2933)
ProfiHub firmware version:	V2.0
ProfiHub diagnostic slave address:	5
Connected to this ComBricks:	Network 1 (Module 1, Channel 1)
Redundancy status:	Redundancy not used
Power 1 connected:	Yes
Power 2 connected:	No
Alarm status:	Active due to the following reason(s): Power error Reset alarm

Internal Diag slave	Main	Ch 1	Ch 2	Ch 3	Ch 4	Ch 5
5	1	0	4	14	24	34
			44	54		

Termination: Off, Off, On, On, On, On

Illegals: 1, 0, 6, 0, 0, 0 Reset illegals

Fig. 31 - Information window of the Diagnostic slave

It displays the following information:

- Address of the Diagnostic slave
- Type and serial number of the Diagnostic slave
- Firmware version of the ProfiHub
- Connection to the channel and network number of the ComBricks
- Redundancy status of the ProfiHub
- Power status of the ProfiHub
- Alarm status (of the relay)
- Termination status of all channels
- Illegal count for all channels
- A live list of all channels

4.4.1 ProfiHub diagnostic slave overview

IP address: 192.168.13.237 | MAC address: 9C:B2:06:00:06:D8 | System uptime: 7 days, 18:55:24
 Site: | Temperature: 44°C | System time: 21-Nov-2018 10:43:15
 Company: | Country:

ProfiHub diagnostic slave info [Show details](#)

Network 1 [Reset all alarms of this network](#) [Reset all illegals of this network](#) [Clear detected devices](#)

B5+RD devices:						Illegals					
Address	Serial#	Firmware version	Tag-name	Alarm status	Timestamp	Main	Ch 1	Ch 2	Ch 3	Ch 4	Ch 5
5	8270	V2.0		Inactive	21-Nov-2018 10:43:10	0	0	0	0	0	0
20	13207	V2.0		Inactive	21-Nov-2018 10:43:12	0	0	0	0	0	0

B2+RD devices:						Illegals		
Address	Serial#	Firmware version	Tag-name	Alarm status	Timestamp	Main	Ch 1	Ch 2
22	2718	V2.0		Inactive	21-Nov-2018 10:43:14	0	0	0

B2FO2+RD devices:						Illegals			
Address	Serial#	Firmware version	Tag-name	Alarm status	Timestamp	FO Ch 1	FO Ch 2	Ch 1	Ch 2
23	406	V2.0		Inactive	21-Nov-2018 10:43:08	0	0	0	0

D1+D devices:						Illegals	
Address	Serial#	Firmware version	Tag-name	Alarm status	Timestamp	Ch 1	Ch 2
21	1599	V2.0		Inactive	21-Nov-2018 10:43:12	0	0

Fig. 32 - ProfiHub slave overview

A ProfiHub Diagnostic slave address is a clickable link in the overview (displayed above) to conveniently jump to the details of that Diagnostic slave. It can be used to determine on what channel a Diagnostic slave is connected if more Diagnostic slaves are installed in the network.

You can perform the following reset functions:

- Reset all alarms of all Diagnostic ProfiHubs in the network.
- Reset the illegals of all channels of all Diagnostic ProfiHubs in the network
- Clear all detected Diagnostic ProfiHubs, so that the list of Diagnostic ProfiHubs is repopulated.

4.5 General configuration

Head Stations: **1A, 1B, 1C**
 Firmware: **V1.140 and higher**
 Login: **Administrator**

The basic settings of the ComBricks are customized on the 'General configuration' page. For optimal use of ProfiTrace OE, it is important that the time is synchronized and the site info is sufficiently filled in (see Fig. 33). If your ComBricks is connected to Internet or a local NTP server, use the NTP server synchronization for automatic date & time update. This keeps your ComBricks always set to the right time (this option is available in Head Station firmware v1.278 and up). If the ComBricks clock differs more than 10 seconds from the NTP clock, a line in the system log is added.

The automatic time update occurs when the set interval has passed. The maximum interval that can be set is 1440 minutes, which corresponds to 24 hours. Please note that there is no option for auto-updating to Daylight

Saving Time (DST). This is because this is not used in Factory Automation. When an NTP server is used, the time is always assumed to be winter time.



Fig. 33 - General configuration

The display refresh rate has to be tuned to the bandwidth of the Ethernet connection. By default it is set to a 1 second automatic refresh. If the bandwidth is limited, it is recommended to increase this time or to switch the automatic refresh OFF (see Fig. 33).

It is possible to select the start page which is first displayed when browsing to the Head Station IP address. You can select the Main Status page, System Log page, Live List, Statistics, Channel list Message Recording or Network Event log. You can also select for which network this should apply.

The interface language can be changed in the Preferred Language drop-down box. More languages will be added in the future, which will become available in new firmware updates.

4.6 Network configuration

Head Stations: **1A, 1B, 1C**
 Firmware: **V1.252 and higher**
 Login: **Administrator**

The network names and the assignment of the repeater modules are customized here. For optimal use of ProfiTrace OE, it is important that correct and understandable network names are defined (see Fig. 34). The network names are used in multiple components: ProfiTrace Live List, event emails, message recording, etc.

Each of the 4 Live Lists can be individually setup to a different time-out. The default value is 5 seconds. The time indicates how long a slave will be displayed as green when it has lost communication to the master. After the set time it will turn yellow if it has no communication anymore.

The network assignment of the repeater modules is also displayed and can be adjusted if software settings are enabled (see Fig. 34). It is possible to assign a module to Network 1 to 4, or to disconnect it from the backplanes. This makes it possible to create a multiplexed system, or temporarily remove certain slaves from the PROFIBUS network.

Dipswitch settings are always primary to software settings.

PROCENTEC ComBricks

IP address: 192.168.1.250 MAC address: 9C:B2:06:00:04:6A System uptime: 0 days, 1:01:59
 Site: PTK-J Temperature: 38°C System time: 21-Mar-2013 14:56:39
 Company: PROCENTEC Country: The Netherlands

Network configuration

Network #	Name	Livelist timeout (sec)
Network name 1:	Network 1	3
Network name 2:	Network 2	3
Network name 3:	Network 3	3
Network name 4:	Network 4	3

Slot	Module	Channel	Set by	Current Network	Current Redund.	Set Network (if Software)	Set Redund. (if Software)
1	2 Channel RS485 Repeater Type 1 slot1	Ch 1	Software	1	Off	1	<input type="checkbox"/>
		Ch 2	Software	1	Off	1	<input type="checkbox"/>
2	1 Channel RS485 SCOPE Repeater Type 1 slot2	Ch 1	Dipswitch	1	Off	1	<input type="checkbox"/>
3	PROFIBUS DP Slave Type 1 slot3	Ch 1	Dipswitch	1	Off	4	<input type="checkbox"/>
4	4 Channel REL module Type abc						
5	8 Channel DIG I/O module Type 1						
6	1 Channel PA-coupler 500mA Type 1	Ch 1	Dipswitch	1	C		
7	Empty						
8	Empty						
9	Empty						
10	Empty						

Fig. 34 - Network configuration

4.7 IP Configuration

Head Stations:	1A, 1B, 1C
Firmware:	V1.252 and higher
Login:	Administrator

The IP Configuration screen offers some basic IP settings.

The DHCP functionality can be enabled. If the ComBricks will be connected to a network where a DHCP server is active, the settings can be automatically set into the ComBricks by enabling this feature. The IP address will be set by the DHCP server.

If a fixed IP address is needed, enter it manually in the 'IP address' box. By default the IP address is 192.168.1.254. Next, enter the subnet mask, default gateway and DNS server according to the settings of the network. For more information, contact the network administrator.

Please note that changing the DNS server address requires a soft-reboot of the Head Station before the new setting becomes active. Soft-resetting the Head Station does not affect repeater modules; this is a separate process. You can safely soft-reset the Head Station without disrupting the repeater-functionality.

4.7.1 Server port configuration

The ports of the following internal servers of the ComBricks can be changed:

- Web server (default port is 80)
- Streaming server (default port is 38888)
- CommDTM server (default port is 38890)

You can enter any port number between 1024 and 65535. Simply enter a valid port number and press 'Apply'. Changes will be effective immediately; no reboot is required.

Note about the Web server port: if you change the default port of the web server, you will lose the current connection to the ComBricks. When the port is changed, the ComBricks will ask you if you want to connect to the new port. If the Streaming or CommDTM server ports are changed, also change this on the client side and (if applicable) update firewall rules and/or router setup. Contact your system administrator for this.

4.8 Output Control

Head Stations: **1A, 1B, 1C**
 Firmware: **V1.254 and higher**
 Login: **User**

With the Output Control feature the user can directly respond to an event with the onboard relay in the Head Station or the channels from output modules in the backplane. The web server offers 10 customizable controls that can be set to the following behavior:

- Not active
- Manual ON/OFF Live toggle of the output channels
- Time Time ON and Time OFF
- PROFIBUS event Syncs, retries, bus voltage too low, redundancy failure, PA failure, fiber optic failure etc.
- System event Redundant power change or ComBricks failures

Control	Slot/module	I/O Point	Current state	Action
1	Headstation relay 24V/0.25A (Rel 0	Off	Profibus event
2	Slot 6 / 4 Channel REL module	Rel 0	On	Manually
3	Slot 6 / 4 Channel REL module	Rel 1	On	Time (24h)
4	Slot 6 / 4 Channel REL module	Rel 2	Off	System event
5	Slot 6 / 4 Channel REL module	Rel 3	Off	Profibus event
6	None	None	Unknown	None
7	None	None	Unknown	None
8	None	None	Unknown	None
9	None	None	Unknown	None

Fig. 35 - Output Control



After power down/up, the ComBricks loads and restores these settings.



It is recommended to have a security policy concerning passwords with this feature, because the user is able to control REAL output points.

4.9 Password setup and login

Head Stations: **1A, 1B, 1C**
Firmware: **V1.100 and higher**
Login: **Administrator**



Passwords are NOT activated when the product is purchased or reset and all menu items are accessible and adjustable.

ComBricks supports 2 types of passwords;

User: Is limited to read information
Administrator: Has access to the full web server and can adjust settings

- The Administrator password has to be set first.
- The passwords can have a length between 1 and 16 characters.

Fig. 36 illustrates the password setup web page.

4.9.1 Access rights

After a password(s) has been setup, it complies with the access rights from **Table 1**.

Table 1 - Access rights after password setup

	NO Passwords	Administrator	User (Admin. is set)
Login required at web server access	NO	NO ³	YES
Visiting web pages	YES	YES	YES
Clear "System log"	YES	YES	YES
Restart the device in the "Device management"	YES	YES	YES
Output Control	YES	YES	YES
Changing passwords	YES	YES	NO
Adjusting all other settings	YES	YES	NO

³ When only the Administrator login has been activated, the user can always enter the web server without a valid login. When settings need to be altered, the administrator is required to login.

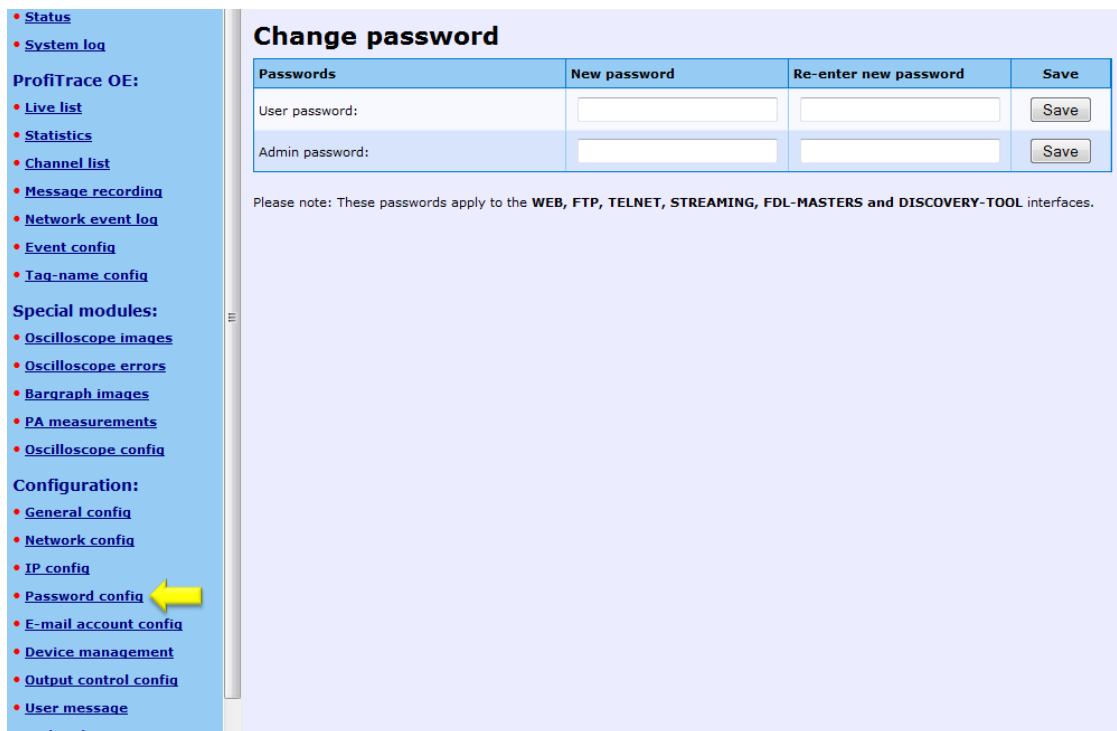

Passwords	New password	Re-enter new password	Save
User password:	<input type="text"/>	<input type="text"/>	<input type="button" value="Save"/>
Admin password:	<input type="text"/>	<input type="text"/>	<input type="button" value="Save"/>

Please note: These passwords apply to the **WEB, FTP, TELNET, STREAMING, FDL-MASTERS and DISCOVERY-TOOL** interfaces.

Fig. 36 - Password setup

4.9.2 Password best practice

We encourage you to at least setup the Administrator password if more than 1 person has access to the network.

- Activate the password(s) immediately after installation or at the office before it is transported to the final destination.
- Use different passwords for the Administrator and User.
- Never share passwords with anyone.
- Always use strong passwords. Avoid: *test, 123456, <your company name>, <your first name>, ComBricks, PROCENTEC, etc.*
- Change passwords immediately if they may have been compromised.
- If passwords must be written down, store it in a secure place and destroy it when it is no longer needed.
- Be careful about where passwords are saved on computers. Some dialog boxes, such as those for remote access, present an option to save or remember passwords. Selecting this option poses a potential security threat.

4.9.3 External protocols

The following login information is required for external protocols, for example for FTP and TELNET.

User: **user or admin**
Administrator: **<your password>**

Any FTP client can be used to setup the FTP connection. ComBricks uses port 21.

If you have not set a password, ComBricks will accept any password during the connection phase. Some FTP clients require a password, so you can provide any password.

4.9.4 Clearing password(s)

There are 3 ways to restore the password(s) to their default setting:

- Change the passwords with no text written in the text field (*Administrator login required*).
- Restore to factory default settings in the "Device management" page (*Administrator login required*).
- Restore to factory default settings with the switch on the front of the Head Station (see **Paragraph 6.5**).

4.10 License update

Head Stations: **1A, 1B, 1C**
Firmware: **V1.254 and higher**
Login: **Administrator**

In case the user wants to update the license of the Head Station, it can be done here via an internet connection or copy the content of a license file.

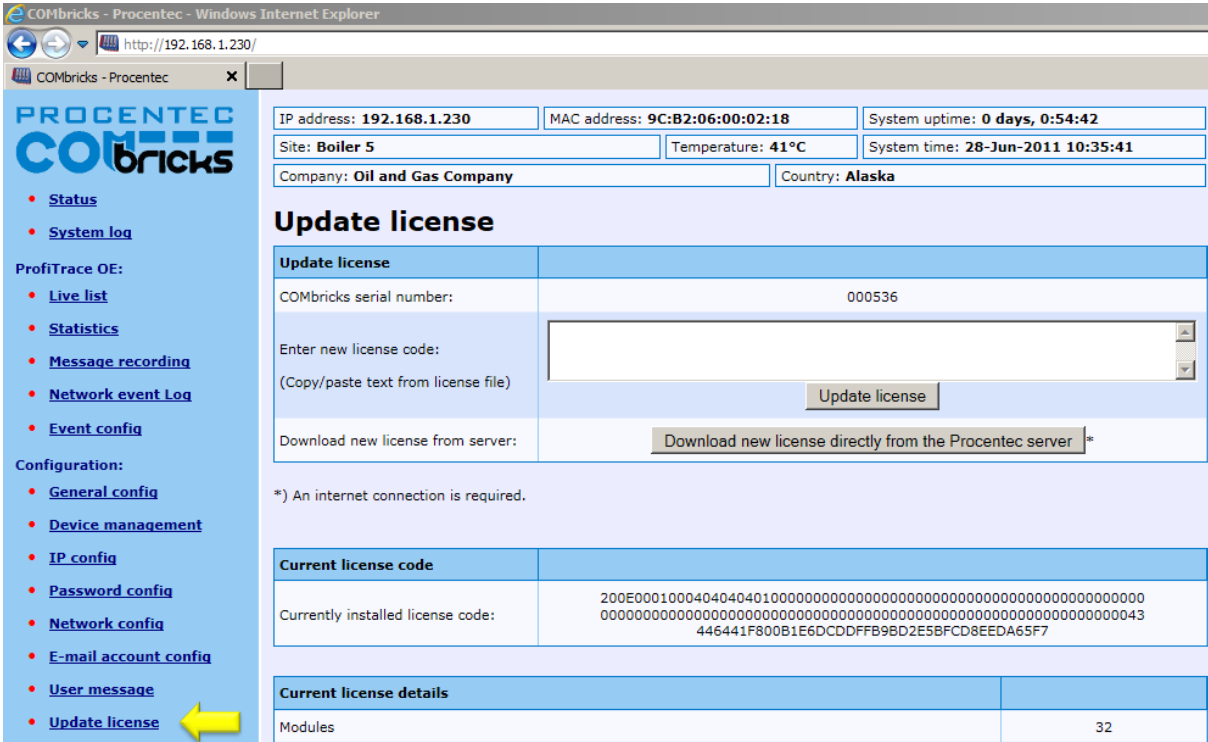

Fig. 37 - License update

4.11 Document download page

Head Stations: **1A, 1B, 1C**
Firmware: **V1.254 and higher**
Login: **User or administrator**

To provide the user with documentation, firmware and software, the SD card has been provided with a document download page (see **Fig. 38**).

- Download the latest version of the document download page from www.procentec.com
- The content of the .ZIP file has to be copied to a directory \DOC on the SD card.
- If the directory does NOT exist, create it and copy the content of the .ZIP file to it.
- Reload the web server to update the information.
- There should be an item called "Downloads" on the bottom of the left menu

It is possible to replace the PROCENTEC download page with a customized version. Replace *index.html* with your own version and you can point to directories/files which are located on the SD card. If you are interested in such activities, we recommend you to inspect the structure of the PROCENTEC index.html first.

PROCENTEC ComBricks

- [Status](#)
- [System log](#)
- ProfiTrace OE:
 - [Live list](#)
 - [Statistics](#)
 - [Message recording](#)
 - [Network event Log](#)
 - [Event config](#)
- Configuration:
 - [General config](#)
 - [Network config](#)
 - [IP config](#)
 - [Password config](#)
 - [E-mail account config](#)
 - [Device management](#)
 - [User message](#)
 - [Update license](#)
 - [Downloads](#)

Software and Document Downloads

Documents					
	SD card: User Manual	Download the latest version from internet	21-08-2011		5,0M
	SD card: Datasheet - Head Station 1A/1B/1C	Download the latest version from internet	12-04-2011		1,0M
	SD card: Datasheet - 2CH repeater T1 module	Download the latest version from internet	16-06-2011		1,0M
	SD card: Datasheet - 1CH repeater T1 module	Download the latest version from internet	16-06-2011		1,0M

Software					
	SD card: Discovery Tool V1.3.2	Form to download the latest version	01-03-2011		1,0M
	SD card: Firmware Update Tool V1.5	Form to download the latest version	01-03-2011		1,0M

Firmware					
	SD card: Head Station Type 1 Firmware V1.253	Form to download the latest version	09-08-2011		3,0M

Fig. 38 - Software and document downloads

4.12 Email account config

Head Stations: **1A, 1B, 1C**
 Firmware: **V1.253 and higher (email groups since v1.293)**
 Login: **Administrator**

The email account information has to be entered if the user wants to have ComBricks signal events by email. The required information is generally the same as any other email related setup (see **Fig. 39**).

 Setting up the email server parameters is not enough. The events that generate the emails have to be setup in the 'Event config' menu (see **Paragraph 5.4**).

 The SMTP server has to support **unencrypted** connections, because the current ComBricks firmware does NOT support encrypted connections such as SSL/TLS. The DNS address (IP config menu) has to be modified according to the DNS addresses of your internet provider.

Since Head Station version v1.293 you can setup multiple email groups. Each group can receive emails triggered by different events, which can be set up in 'Event config' in **paragraph 5.4**.

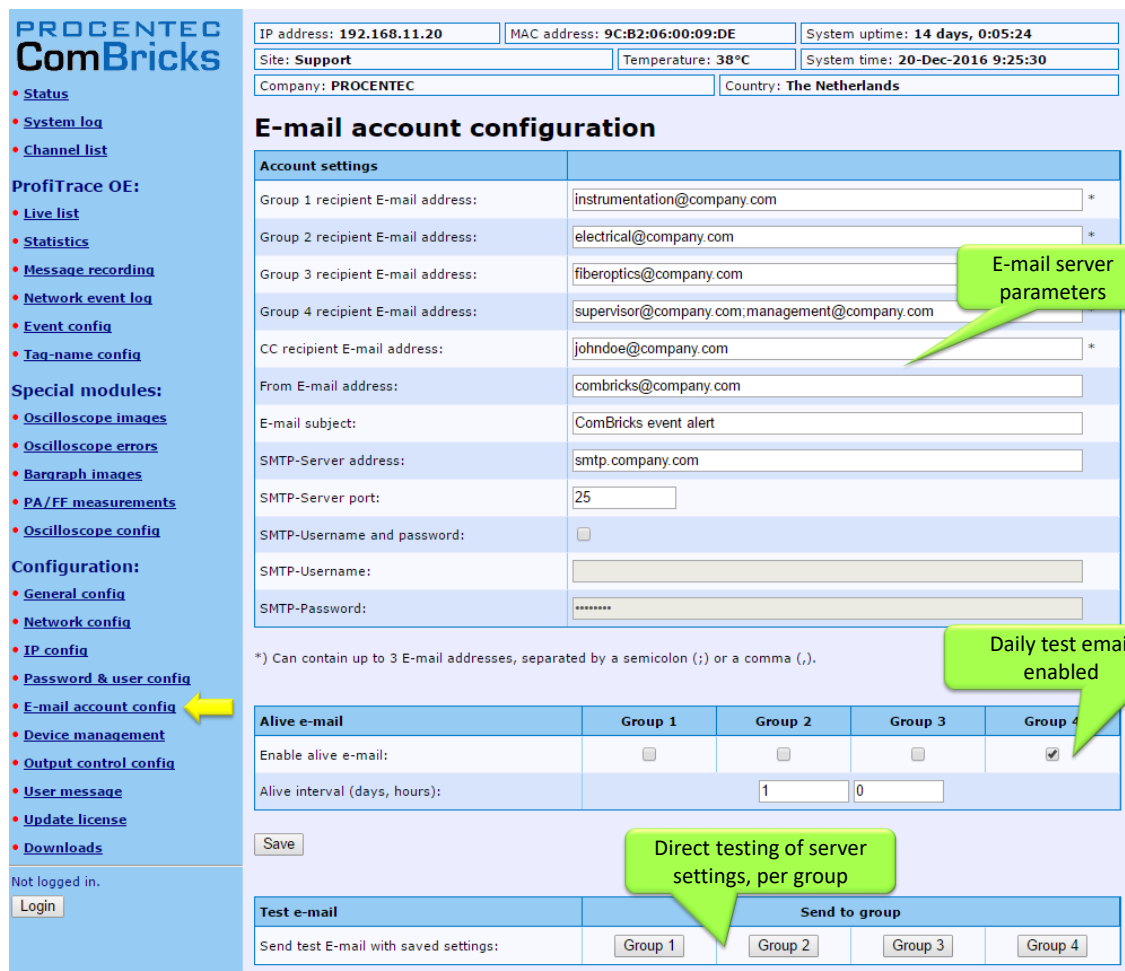

PROCENTEC ComBricks

IP address: 192.168.11.20 MAC address: 9C:B2:06:00:09:DE System uptime: 14 days, 0:05:24
 Site: Support Temperature: 38°C System time: 20-Dec-2016 9:25:30
 Company: PROCENTEC Country: The Netherlands

E-mail account configuration

Account settings

Group 1 recipient E-mail address: instrumentation@company.com *

Group 2 recipient E-mail address: electrical@company.com *

Group 3 recipient E-mail address: fiberoptics@company.com

Group 4 recipient E-mail address: supervisor@company.com;management@company.com

CC recipient E-mail address: johndoe@company.com *

From E-mail address: combricks@company.com

E-mail subject: ComBricks event alert

SMTP-Server address: smtp.company.com

SMTP-Server port: 25

SMTP-Username and password:

SMTP-Username:

SMTP-Password:

*) Can contain up to 3 E-mail addresses, separated by a semicolon (;) or a comma (,).

Alive e-mail

	Group 1	Group 2	Group 3	Group 4
Enable alive e-mail:	<input type="checkbox"/>	<input type="checkbox"/>	<input type="checkbox"/>	<input checked="" type="checkbox"/>
Alive interval (days, hours):	1 0			

Save

Test e-mail

Send test E-mail with saved settings:

	Group 1	Group 2	Group 3	Group 4
	<input type="button" value="Group 1"/>	<input type="button" value="Group 2"/>	<input type="button" value="Group 3"/>	<input type="button" value="Group 4"/>

Fig. 39 - Email configuration

The server parameters have to comply with the email server parameters listed in **Table 2**.

Table 2 - Email server parameters

Server parameters	Mandatory	Additional information	Size
Groups 1 - 4	At least one group	If you enter multiple addresses (max. 3) separate them with the ; character.	200
Cc	Optional	If you enter multiple addresses (max. 3) separate them with the ; character.	200
From	Yes	Depending on the email server you are using, this has to be an existing email address.	100
Subject	Optional	Can be anything you want it to be.	100
SMTP server	Yes	Has to be setup according to the requirements of the email server.	100
SMTP server port	Yes	Standard value for most servers has already been entered, but has to be setup according to the requirements of the email server.	
User name	Optional	A User name can be entered if the SMTP server requires it. Click on "SMTP-Username and password" first.	50
Password	Optional	A password can be entered if the SMTP server requires it. Click on "SMTP-Username and password" first.	50

When you have filled in all server parameters, click on "Save". The settings can be tested by clicking on "Send test email with saved settings".



Save the settings first before sending the test email!

It might take a couple of minutes before the test email has been received by the recipient.

If the test-email has not been received, please check if it has been blocked by a Spam filter.

4.12.1 Alive email

ComBricks can send a periodic alive-email to the recipient group(s) entered in the Group: field. If no events are triggered for a longer period, ComBricks will not send emails. This also happens when ComBricks has no connection to the mail server for some reason. The alive email is an automated check to see that the connection is still active.

ComBricks can auto-send an email with adjustable interval of anything between one hour and 365 days.

4.12.2 Email Troubleshooting

- Check if ComBricks has access to the internet. You can easily test this by going to the Download page in the ComBricks menu and download a datasheet from the web.
- Compare the DNS settings with the requirements of the email server you are using.
- Make sure your email server supports unsecured connections (secured connections are not possible).
- Check the email settings and generate the test email. Start with only 1 email address.
- If the test email works, please check that your events have been correctly enabled and an event is really triggered.

4.13 Device Management

Head Stations: **1A, 1B, 1C**
Firmware: **V1.253 and higher**
Login: **Administrator**

The Device Management page allows the user to perform backup, restore and restart actions for the ComBricks. When maintenance is being performed to a network, the ComBricks systems of the relevant network can be put into a Maintenance Mode. For some actions Administrator login is required.

PROCENTEC ComBricks

IP address: 192.168.1.254 MAC address: 9C:B2:06:00:05:8A System uptime: 0 days, 0:42:08
Site: PTK K Temperature: 45°C System time: 24-Oct-2018 10:25:07
Company: PROCENTEC Country: The Netherlands

Device management

Backup or restore settings	
Backup settings from internal memory to SD-card	<input type="button" value="Backup settings to SD-Card"/>
Restore settings from SD-card to internal memory	<input type="button" value="Restore settings from SD-Card"/>

Reset to defaults	
Restore settings to factory defaults:	<input type="button" value="Restore settings to factory defaults"/>
Clear all gathered information:	<input type="button" value="Clear all data"/>

Restart device	
Restart the device (soft-reset):	<input type="button" value="Restart the device"/>

Maintenance mode	
Enable maintenance mode:	<input type="button" value="Enable maintenance mode"/>

Not logged in.

Left sidebar menu items: Status, System log, Channel list, ProfiTrace OE: Live list, Statistics, Message recording, Network event log, Email & Log event config, Output event config, SNMP event config, Tag-name config, Special modules: Oscilloscope images, Oscilloscope errors, Bargraph images, PA/FF measurements, Oscilloscope config, Configuration: General config, Network config, IP config, Password & user config, E-mail account config, **Device management** (highlighted with yellow arrow), User message, Update license, Downloads.

4.13.1 Backup settings to SD-Card

When this button is clicked, all customizable settings of each individual network and of the Head Station are saved to SD-Card. These settings include Message recording settings, name and identification tags, scope settings and IP and email settings.

This feature allows a quick and easy replacement of a defective Head Station. If a Head Station needs to be replaced, and settings have been backed up on SD card, remove the SD card from the slot and place it in the new Head Station. Then continue with **paragraph 4.13.2**.

4.13.2 Restore settings from SD-Card

When you replaced the SD card with information from another Head Station, click 'Restore settings from SD Card' to load all information into the new Head Station. Then click 'OK' on the confirmation window. Settings are loaded and activated instantly; no restart is required.

4.13.3 Restore settings to factory defaults

This button clears all entered information and restores the ComBricks Head Station to the default factory values. The new IP address is 192.168.1.254

4.13.4 Clear all data

When a ComBricks set has been installed and is ready for normal operation, it may have recorded several events which are not 'real' faults. This can happen during wiring or commissioning phase. Press 'Clear all data' to start the ComBricks logging and recording functions with a clear memory. Then click 'OK' on the confirmation window.

IMPORTANT NOTE: This will clear all Message Recording files, oscilloscope / bargraph images and log files!

4.13.5 Restart the device

To restart the device, for example to let it read new dipswitch settings or DNS server settings, click the 'Restart the device' button. Then click 'OK' on the confirmation window.

This 'soft'-reset will not affect PROFIBUS communication on the repeater modules; the repeater functionality will continue during reset.

4.13.6 Maintenance mode

The Maintenance Mode allows you to suspend all alerts and logs of the ComBricks. It still displays the current state of the Live List, Channel list, Oscilloscope signals and Bargraph values, but no changes will be recorded. The current state of the channel list, illegals and Alarms of the Diagnostic Hubs is also displayed in the Maintenance Mode.

After enabling the Maintenance Mode, a large red window will be visible on all pages as a reminder. It also has a 'Disable' button to deactivate Maintenance Mode.

In Maintenance mode:

- Statistics will keep the same value.
- Bargraph Min/Max will keep the same value.
- Message recording will be temporarily stopped.
- Oscilloscope images Min/Max will be reset as soon as maintenance mode is disabled.

- Oscilloscope error images will be discarded as soon as maintenance mode is disabled.
- All network related Email, Log, SNMP Trap and Output events are blocked.

The Maintenance Mode can be individually enabled or disabled on each of the 4 networks.

4.14 Diagnostic Slave configuration

This feature enables the use of an internal master in the Head Station, that retrieves diagnostic information from a ProfiHub in the field. This is done automatically; only the master settings need to be adjusted.

All four networks can be scanned for diagnostic slaves. The internal master will retrieve the data one-by-one, not simultaneously. When the data is transferred from the first Diagnostic slave, the ComBricks master will stop and continue its operation on the next network.

Before setting up this feature, make sure to get all the requested busparameter information from the PLC/DCS. All busparameters can be found in the configuration tool of that master. Most of the busparameters can also be auto-detected by clicking on 'Auto detect', but this does not guarantee correct values.

Warning:



Using incorrect master settings may disrupt PROFIBUS communication between other masters and slaves on the network.

PROCENTEC ComBricks

IP address: 192.168.1.254 MAC address: 9C:B2:06:00:05:8A System uptime: 0 days, 1:42:07
 Site: PTK K Temperature: 46°C System time: 24-Oct-2018 16:11:21
 Company: PROCENTEC Country: The Netherlands

Diagnostic slave configuration

With this feature the Diagnostic slaves of the ProfiHub family can be read out using the internal Profibus master of the Head Station. Configure the internal Profibus master to operate on the connected Profibus networks.

Current status				
Master state:	Master is scanning network 1			

Master configuration	Network 1	Network 2	Network 3	Network 4
Scanning of Diagnostic slaves enabled:	<input checked="" type="checkbox"/>	<input checked="" type="checkbox"/>	<input type="checkbox"/>	<input type="checkbox"/>
Baud rate * :	1.5 Mbps	1.5 Mbps	1.5 Mbps	1.5 Mbps
Master address * :	0	0	0	0
Slot time (tBit) * :	300	300	300	300
Min. station delay (tBit):	11	11	11	11
Max. station delay (tBit) * :	150	150	150	150
Setup time (tBit) * :	1	1	1	1
Quiet time (tBit) * :	0	0	0	0
Highest station address (HSA) * :	126	126	126	126
Retry limit:	5	5	5	5
Target rotation time (tBit):	20000	20000	20000	20000
Gap update factor:	1	1	1	1
Autodetect bus parameters: (Bus parameters with an asterisk (*) are auto detectable)	Auto detect	Auto detect	Auto detect	Auto detect

Save

Fig. 40 - Master settings for the Diagnostic slave

When you have set the correct busparameters and click 'Save', a pup-up screen will appear asking you to confirm the warnings. After you checked the confirmation checkbox and click save, the information will become available in the Diagnostic Slave info (see paragraph 4.4).

5 ProfiTrace OE

ProfiTrace OE (Over Ethernet) is a web based version of ProfiTrace. It offers the basic functionality of regular ProfiTrace, like; Live List, Statistics and Message recording. ProfiTrace OE is available on the Head Stations 1B and 1C.

5.1 Live List

The Live List is a matrix that continuously lists all the available devices. It is directly visible which devices are 'troublemakers'. With different background colors, the status of the devices is displayed (see Fig. 41):

- Green: Device is in Data Exchange
- Yellow: Device is lost (the time-out is adjustable, see paragraph 4.6)
- Red: Parameter fault
- Purple: Configuration fault
- No color: On the bus but not in Data Exchange

The Live List can also generate the product name of the devices when a diagnostic message is captured (synchronized with the GSD library).

The button 'Display Legend' pops up a window explaining all colours in more detail.

The button 'Reset Live List' will clear the current state of the Live List and rebuild it according to the nodes that are currently active on the network. You have the option of resetting or keeping the discovered Ident numbers, after you have pressed the button.

The screenshot shows the ProfiTrace OE web interface. The left sidebar contains a navigation menu with 'Live list' selected. The main content area displays a 'Live list' section with a grid of device status. The grid has columns for Tank 1, Tank 2, Reserve Tank 1, and Reserve Tank 2, and rows for device addresses from 0 to 89. A callout box points to the 'Monitoring 4 networks' section. Another callout box points to a green cell in the grid, stating 'Similar Live List as ProfiTrace 2'.

	0	1	2	3	4	5	6	7	8	9
0	0	1	2	3	4	5	6	7	8	9
10	10	11	12	Heidenhain Encoder	14	VM10 NORGREN	16	17	18	19
20	20	21	22	23	750-333 WAGO	25	26	GPL-DT4 LGIS	28	29
30	30	31	750-333 WAGO	33	34	35	ET200S SIEMENS	37	38	39
40	40	41	42	43	44	45	46	47	48	49
50	50	51	52	53	54	BPS34 LEUZE	56	57	58	59
60	60	61	62	63	64	65	66	67	68	69
70	70	71	72	73	74	75	76	77	78	79
80	80	81	82	ILBPBA14AG PHOENIX	84	85	86	87	88	89

Fig. 41 - ProfiTrace Live List

5.1.1 Updating the GSD file library

The procedure below describes how to update the GSD file information in ComBricks so that all devices in the Live List have a full model name.

- STEP 1:** Start regular ProfiTrace (2.6 or higher, no license required).
- STEP 2:** Copy all GSD files you require into the ProfiTrace GSD directory. This is usually ".....\ProfiTrace_Vx_x_x\GSD".
- STEP 3:** Create a ComBricks GSD library (Settings > Create ComBricks GSD library). A question is asked if you want to re-scan the GSD files. Select YES followed by (re)Scan GSDs. Click 'Close' when the process has been finalized.
- STEP 4:** A pop-up box allows us to select the destination folder. Select a (temporary) destination folder for the file *GSD.BIN*, for example the Windows desktop.)
- STEP 5:** GSD.BIN has to be copied to the SD card of the ComBricks. You can do this by inserting it in your PC or FTP (admin account).
- STEP 6:** After inserting the SD card back into the Head Station or closing the FTP session, the GSD information is directly available in the Live List. **Paragraph 18.1** describes a method of testing the updated GSD.BIN.

5.2 Statistics

“Click and go...”

The statistics matrix is a powerful feature of the analyzer. This field can really indicate what the condition of the installation is. It displays all the important information that a user, especially a maintenance technician, is really interested in (see **Fig. 42**):

- Retry messages
- Fall-outs (losts)
- Diagnostic messages
- Location of the connected devices, etc.

Paragraph 5.10 describes the statistics and when they occur.

Because of this feature, the user does not have to inspect messages or do difficult operations to ensure the quality of the installation.

If the statistics do NOT show deviations, the installation appears to be running correctly.

Here it stops for the technician who is only interested in a quick feedback. The advanced technician can proceed with a message recording and an inspection of the signal quality.

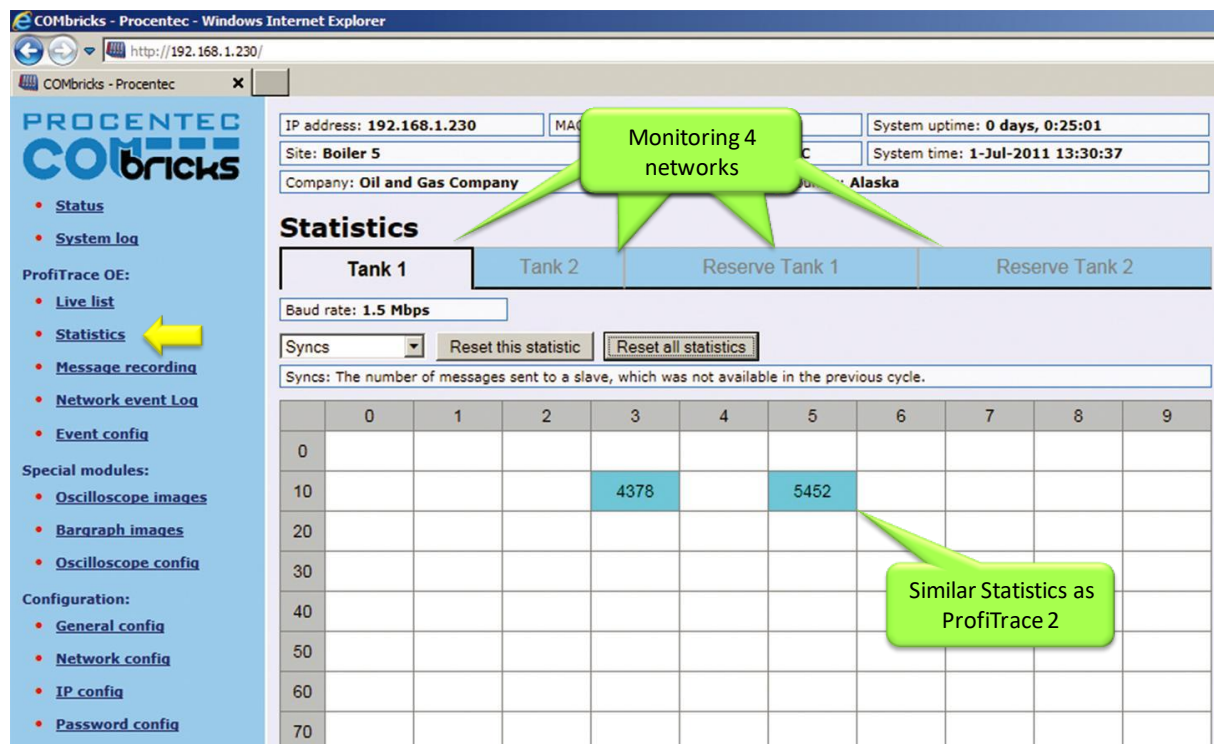

Fig. 42 - ProfiTrace OE Statistics

5.3 Message recording

“Catch it all...”

The message recording in ProfiTrace OE follows a different strategy than ProfiTrace 2. Within ProfiTrace 2, the user needs to setup the message recording first and is he responsible to start it himself.

Because ComBricks is a unit for permanent monitoring, it automatically starts a message recording when an event has been detected. The following event automatically starts a message recording again.

When the unit is purchased or reset, it is automatically triggered on the statistic "Lost". This works directly after startup. The user can change the settings during operation (see Fig. 43).

The recorded files can be opened with an offline ProfiTrace 2 (no license required).

The screenshot displays the ProfiTrace OE configuration interface. On the left is a sidebar with navigation options: Live list, Statistics, Message recording (highlighted with a yellow arrow), Network event Log, Event config, and Special modules (Oscilloscope images, Bargraph images, Oscilloscope config). Below these are Configuration options: General config, Network config, IP config, Password config, E-mail account config, Device management, User message, Update license, and Downloads. The main area is titled 'Tank 1' and contains 'Trigger settings' for 'Lost' events. A callout points to the 'Lost' trigger, stating 'Trigger settings. Lost is default'. The settings include checkboxes for 'Int. diag', 'Ext. diag', and 'Diag while in Dx', and input fields for 'Message count before trigger' and 'Message count after trigger', both set to 10. A callout points to these fields, stating 'Recording range'. Below the settings is a 'Capture status' section with 'start message recording' and 'stop message recording' buttons, and a checked 'Auto re-trigger' checkbox. A callout points to this checkbox, stating 'Automatic re-triggering'. At the bottom is a table of 'Recorded files' with columns for file name, message count, triggered event, file date & time, and a delete button. A callout points to the first two rows, stating 'Already recorded files from network 1'.

Recorded files	Message count (before/after trigger)	Triggered event	File date & time	Delete file
000203_Nw1_2.ptc	10/10	Lost	1-Jul-2011 13:30:26	Delete
000203_Nw1_1.ptc	10/10	Lost	1-Jul-2011 13:30:22	Delete

Fig. 43 - Setup recording trigger



The automatic triggering can generate 1000 .PTC files per network⁴. After 1000 files have been generated, the follow-up event will delete the oldest file and replace it with the latest event. This system secures the storage space of the SD card.



.PTC files can be opened with ProfiTrace 2.5.3 and higher (offline and no licenses required).

The file name contains the MAC address of the Head Station, the network number and the file number (0-999).

5.4 Email & Log event configuration

For generating emails and entries in the network log, the event configuration has to be set for each network. **Fig. 44** shows an example with multiple event options. Since Head Station version v1.293 it is possible to send emails of individual events to specific email groups (see also **paragraph 4.12**). This is useful for large organizations with different maintenance teams or user groups.

Paragraph 5.10 describes the events and when they occur.

Fig. 44 - Event configuration

To reduce an unwanted overload of emails or log entries, the events can be set to Off, Once or Interval.

⁴ This feature is available in firmware version 1.264 and higher.

Event parameter	Description	Retrigger required
Off	No event generation.	
Once	Event will be generated once (1-shot).	Yes
Interval	Event will be generated once within the customized interval time. After the interval time the event is automatically retriggered to be generated in the next interval. If no trigger was captured in the new interval period, no event will be generated.	No

The interval time can be customized between 1 minute and 365 days.

5.5 SNMP event config

ComBricks can send SNMP trap messages to network clients, to signal certain events automatically. SNMPv2c is used for this, which by default communicates over UDP port 162. Note: The events of the Power Module are supported from hardware version v1.4 and higher of the Power Module. Power module hardware version v1.3 can be used, but does not correctly trigger the “External power failure” and “External power restored” traps.

PROCENTEC ComBricks

- [Status](#)
- [System log](#)
- [Channel list](#)

ProfiTrace OE:

- [Live list](#)
- [Statistics](#)
- [Message recording](#)
- [Network event log](#)
- [Email & Log event config](#)
- [Output event config](#)
- [SNMP event config](#)
- [Tag-name config](#)

Configuration:

- [General config](#)
- [Network config](#)
- [IP config](#)
- [Password & user config](#)
- [E-mail account config](#)
- [Device management](#)
- [User message](#)
- [Update license](#)
- [Downloads](#)

Not logged in.
[Login](#)

SNMP configuration

SNMP Request/Response configuration	
SNMP community string:	public

SNMP Trap configuration	
SNMP Trap recipients:	192.168.11.142 *
SNMP Trap community string:	trap
SNMP Trap destination port: (default port is 162)	162

* Can contain up to 3 IP-Addresses, separated by a semicolon (;) or a comma (,).

SNMP Trap event config	Enable trap
System	
System startup	<input checked="" type="checkbox"/>
Power modules (PWR-6A, 101-230010, Hardware revision V1.4 and newer)	
Load sharing balance failure	<input checked="" type="checkbox"/>
Load sharing balance restored	<input checked="" type="checkbox"/>
External power failure	<input checked="" type="checkbox"/>
External power restore	<input checked="" type="checkbox"/>
Backplane voltage too low	<input checked="" type="checkbox"/>
Backplane voltage too high	<input checked="" type="checkbox"/>
Backplane voltage restored	<input checked="" type="checkbox"/>
Current delivery too high	<input checked="" type="checkbox"/>
Current delivery restored	<input checked="" type="checkbox"/>
Communication failure	<input checked="" type="checkbox"/>
Communication restored	<input checked="" type="checkbox"/>
Module removed from system	<input checked="" type="checkbox"/>
Module reinserted into system	<input checked="" type="checkbox"/>

Fig. 45 - SNMP trap setup page

The first item, 'SNMP Community string', refers to a group of SNMP-devices. All devices with the same Community name can exchange the SNMP information. All SNMP-messages with a different name are ignored. It is recommended to change the Community name to a custom name, and use that same name in the SNMP manager.

In the SNMP Trap recipients field you can enter up to 3 IP addresses. Trap messages are sent to all these addresses. Make sure to separate the IP addresses with a semicolon (;) or a comma (,).

SNMP Trap community string: This is the community string sent along with SNMP traps, and serves the same function as the community string mentioned above.

You can also change the port ComBricks uses to send SNMP traps.

To test this feature, see paragraph 16.3.

5.6 Tag name configuration

Every ComBricks module and every station in every network can be tagged with a name.

The screenshot displays the 'Tag-name configuration' screen in the ComBricks web interface. At the top, there are status fields for IP address (192.168.1.205), MAC address (9C:B2:06:00:02:EA), System uptime (6 days, 1:45:55), Site (Tank 5), Temperature (44°C), System time (14-Mar-2013 15:20:03), Company (Oil and Gas Company), and Country (The Netherlands). The main content area is divided into two sections:

- Tag names for modules:** This section includes instructions to fill in tag names in the edit box on the right. Each tag must be in the format **Slot:Name**. The Slot should be a value from 1 to 32, and each Name is limited to 16 characters. Prohibited characters include Colon (:), quote (' or "), and backslash (\). The example values listed are: 1:To PLC41, 2:Scope 1, 3:Scope 2, 4:Scope 3, 5:To PLC43, 6:PA coupler, 7:To Ex zone, and 8:\test.
- Livelist tag names for network 1:** This section includes instructions to fill in tag names in the edit box on the right. Each tag must be in the format **Address:Name**. The Address should be a value from 0 to 126, and each Name is limited to 16 characters. Prohibited characters include Colon (:), quote (' or "), and backslash (\). The example values listed are: 3:PLC S7-3152FN/DP and 34:1790P-I8BV8B.

A 'Save' button is located below the first table. A yellow arrow in the sidebar points to the 'Tag-name config' option under the 'Special modules' section.

Fig. 46 - Tag name configuration screen

The first block of tag names is used to assign tags to the ComBricks modules.

Each tag must have the format **slot:name**, where slot is the slot number. The tag names are limited to 16 characters. The Colon (:) and quote (' or ") characters cannot be used.

The second to the fifth block of tag names are used to assign tags to individual stations in each network.

Tag names are stored on the SD card. Use the 'Backup' and 'Restore' feature to reload the names if you change the Head Station, see **paragraph 4.13**.

The tag names are visible in the Channel List page if you hover the mouse pointer over a module or station address. It is also possible to show the tag names in the Live List:

IP address: 192.168.1.205 MAC address: 9C:B2:06:00:02:EA
 Site: Tank 5 Temperature: 44°C
 Company: Oil and Gas Company Country: T

Live list

Tank 1 Tank 2 Reserve Tank 1

Baudrate: 1.5 Mbps

Display legend Model_Name Reset Live list

0	0	Model_Name	3	4	5
10	10	Vendor_Name	PLC	4	5
20	20	Min_Slave_Intervall	152PND		
30	30	Max_Diag_Data_Len	13	14	15
40	40	Hardware_Release	23		25
		Software_Release			
		Ident.Nr.	23		25
		Module & Channel Nr.			
		Tag-name			
			33	1790P-18BV8B	35
			43		45

Tag names of modules are also displayed in drop-down references to modules and in tables on the following pages:

- Oscilloscope Images
- Oscilloscope Error Images
- Oscilloscope configuration
- Bar Graphs
- PA measurements
- Network Configuration
- Output Control configuration

5.7 Oscilloscope images

“The easiest PROFIBUS oscilloscope ever...”

SCOPE repeater modules have an integrated oscilloscope to measure the signal quality of the telegrams. The oscilloscope has an interface with the web server to display the signals from the devices which are connected to its channel. After opening the web page, all oscilloscope signals are displayed and updated live.

The SCOPE repeater is the most easy to use PROFIBUS oscilloscope available:

- You do NOT have to touch the installation
- Works automatically, even images saves to SD card (since firmware version 1.286)
- Oscilloscope data is never mistaken with the wrong segment
- No probe wiring
- No spur lines

By clicking on the oscilloscope waveform of a device, the oscilloscope triggers on the respective device and displays its signals in a new page.



The SCOPE repeater is only able to do differential measurements.

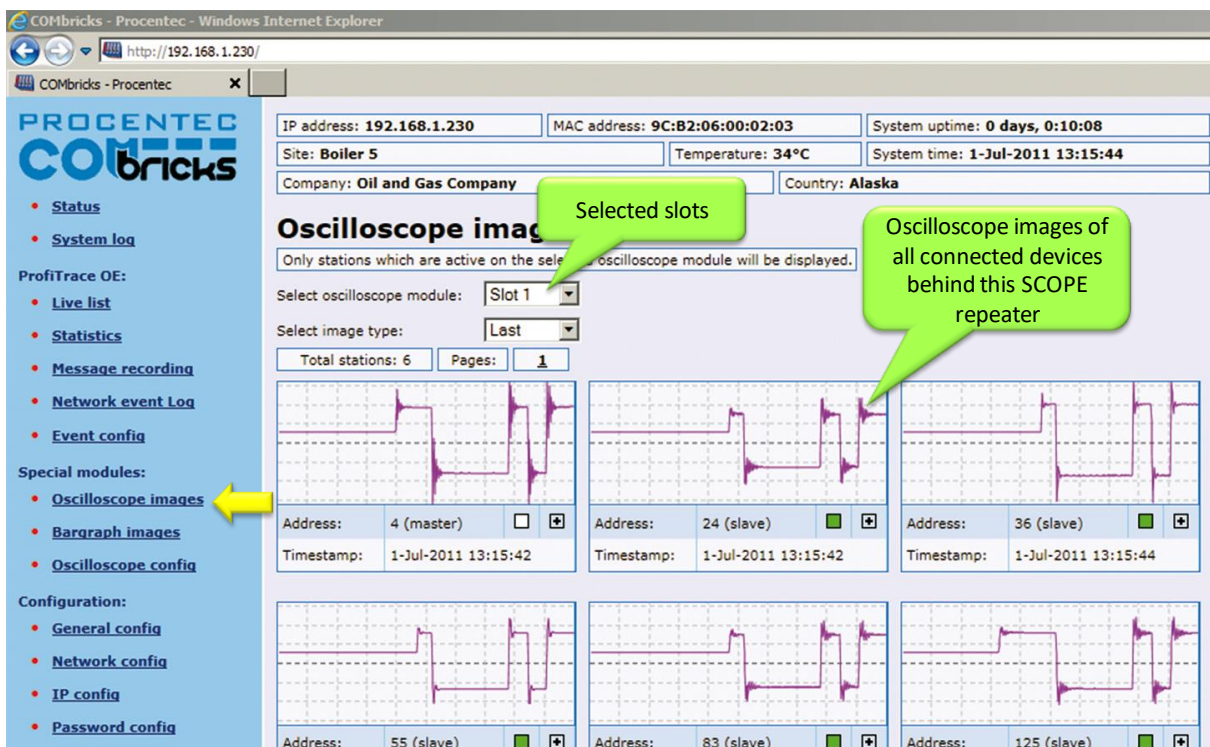

Fig. 47 - Oscilloscope images from all devices

5.7.1 Oscilloscope Configuration

The following changes can be made to the Oscilloscope pages:

- Number of images per page
- Line color
- Error images buffer type
- Auto-save images to SD –card
- Termination min/max level
- Bargraph OK level
- For DP-IS (Ex) and PA modules: Specific trigger levels

Click the Oscilloscope Config in the left menu to change these settings.

PROCENTEC COMBRICKS

IP address: 192.168.11.28 MAC address: 9C:B2:06:00:04:6A System uptime: 0 days, 21:55:48
Site: Production site X Temperature: 41°C System time: 23-Sep-2014 8:42:22
Company: Oil & Gas Company Country: USA

Oscilloscope configuration

General oscilloscope settings

Maximum number of images per page:	9
Line color:	Purple
Error images buffer type:	Ring buffer
Automatically save images to SD card:	<input checked="" type="checkbox"/>

1 Channel RS485 SCOPE Repeater Type 1

Termination min level (mV):	700
Termination max level (mV):	1300
Bargraph OK limit (mV):	2500

Other SCOPE Repeater settings (these settings will be saved in the modules themselves)

Slot	Module	Ch.	Variable	Current value	Lower limit	Upper limit
1	1 Channel RS485 SCOPE Repeater Type 1	Ch1	Idle level	1061 mV	Use above table	Use above table
			Bargraph level	5401 mV	Use above table	

Fig. 48 - Oscilloscope configuration

5.7.1.1 Max number of images per page

You can change the number of scope images per page. If you want a larger overview of all stations, choose a larger number. But keep in mind that one image is updated every second (by default, can be changed in General Settings). So if you have many nodes, it will take a long time to refresh all the images on the page.

5.7.1.2 Line Color

You can change the line color of the scope. Default is purple for clear contrast when printing the page.

5.7.1.3 Error images buffer type

The error images buffer type can be set to Ring Buffer (default) or 'Stop when full'. The ring buffer keeps recording new images to memory, so you can keep refreshing the page for new error messages. The module keeps a maximum of 16 latest images in memory. The 'Stop when full' mode only logs the first 16 error images and 16 into memory, and then stops recording.

5.7.1.4 Auto save images to SD card

This feature (available since firmware version v1.286) makes sure the images are periodically saved to the SD card, so they are not lost in the event of a power-cycle.

Every 15 minutes the following images are saved automatically if they need to be updated:

- The Min and Max image types per address per module (so a maximum of 2 x 127 per module)
- Bar Graph (one per module)
- Error images (maximum 16 per module)

If all images have been saved to SD card, one entry per module will be added to the system log. This makes it possible to check if an image has been saved to SD card after a certain event or error.

The first 16 error images are saved to SD card. After this, the Scope module saves another 16 images in memory. These can be saved manually to SD card by clicking on 'Refresh scope images' in the Oscilloscope Images page of the corresponding module.

The images are saved in an XML-based vector format .svg which can be viewed in any compatible browser. Recommended is Internet Explorer 9 or higher. You can also find freeware SVG file viewers in the Internet.

The images are located in the following folder on the SD card: **/mmc\$/graphs/**

You can access the path via any FTP-capable browser, FTP program or simply put the SD-card in your PC (but make sure the SD card is write-protected when you insert it in the PC). See **paragraph 4.9.3** for more information.

5.7.1.5 Termination level

For regular Scope Repeater modules you can change the Termination min and max trigger level. This changes the idle voltage limit. Normally the idle voltage should be around 1V. You can change the sensitivity of this measurement. If the level is exceeded, the red LED 'TERM' will illuminate.

5.7.1.6 Bargraph OK limit

You can change the red line in the Bar Graph which is the trigger point for the red 'MIN' LED on the Scope module. If the installation is very stable with high amplitudes of 4V and more, you could consider raising the Bargraph OK limit to 3V for example. Or if you have problems with a certain slave which cannot get a higher amplitude than 2.5V, you can lower the limit to 2V.

5.7.2 Oscilloscope Images

The oscilloscope modules can be viewed by clicking on the 'Oscilloscope images' menu on the left of the webserver screen.

If more than one module with Scope functionality has been installed in the ComBricks, you can select that module in the drop-down list and see Scope images from devices connected to that module.

The Image type lets you view the Last, Min or Max scope image. The Min and Max are the lowest and the highest measured amplitudes.

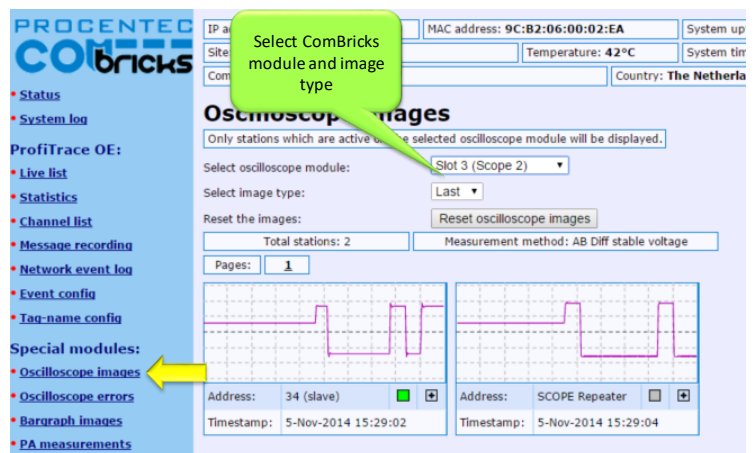

Fig. 49 - Oscilloscope images

When the 'Min' value drops below the configured 'Bargraph OK limit' (default 2.5V) the red LED 'Min' will illuminate on the Scope module. To reset the 'Min' and 'Max' values simply click the 'Reset oscilloscope images' button.

5.7.3 Oscilloscope errors

Whenever an illegal message is seen by ComBricks, and the message occurred on a module with a Scope, you will be able to find the signal of that illegal message. This is very useful for troubleshooting, because it captures the moment of a failure. This makes it easy to prove EMC or other cable problems.

PROCENTEC
ComBricks

IP address: 192.168.11.20 MAC address: 9C:B2:06:00:02:EA System uptime: 9 days, 2:42:04
 Site: Tank 5 Temperature: 42°C System time: 5-Nov-2014 15:27:08
 Company: Oil and Gas Company Country: The Netherlands

Oscilloscope error images

Only the last 16 errors of the selected oscilloscope module will be displayed.

Select oscilloscope module: **Slot 3 (Scope 2)** Select ComBricks module

Refresh the images: (0 Images pending in module)

Reset the images:

Total errors: 13 Pages: **1** 2

Error type: Parity/framing error Timestamp: 4-Nov-2014 10:04:34 Delete image: <input type="button" value="Delete"/>	Error type: Parity/framing error Timestamp: 31-Oct-2014 13:03:12 Delete image: <input type="button" value="Delete"/>	Error type: Parity/framing error Timestamp: 31-Oct-2014 13:03:12 Delete image: <input type="button" value="Delete"/>
Error type: Parity/framing error Timestamp: 31-Oct-2014 13:03:12 Delete image: <input type="button" value="Delete"/>	Error type: Parity/framing error Timestamp: 31-Oct-2014 13:03:12 Delete image: <input type="button" value="Delete"/>	Error type: Parity/framing error Timestamp: 31-Oct-2014 13:03:12 Delete image: <input type="button" value="Delete"/>
Error type: SD error Timestamp: 31-Oct-2014 13:03:12 Delete image: <input type="button" value="Delete"/>	Error type: SD error Timestamp: 31-Oct-2014 13:03:12 Delete image: <input type="button" value="Delete"/>	Error type: Parity/framing error Timestamp: 31-Oct-2014 13:03:12 Delete image: <input type="button" value="Delete"/>

Fig. 50 - Oscilloscope error images

You can view the Scope Error images per slot. The Head Station can hold 16 error images per slot in memory, and if there are more than 16 error images you can click 'Refresh error images' to load these.

To clear all error messages from memory click 'Reset scope error images'.

5.8 Bar graph

The Bar graph illustrates the average signal strength from all available connected devices behind a specific SCOPE repeater. It is a helpful utility to get an impression of the overall signal quality of the network.

The average amplitude should be around 5 V. When there are bus problems the Bar graph will display different Voltage levels and the color of the bars will change.

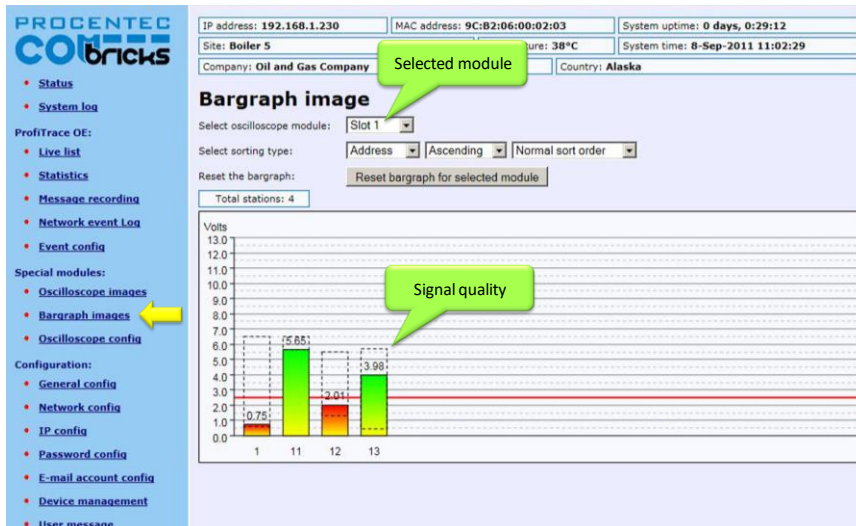

Fig. 51 - Bar graph

5.9 Streaming with ProfiTrace 2

Streaming with ProfiTrace 2 is a feature that allows the user to use the ProfiTrace 2 software and create a scenario as if a ProfiCore is connected to the PC. ProfiTrace 2 is a software tool used by thousands of engineers worldwide, so there is much experience with this tool. A license for ProfiTrace 2 is NOT required!

Streaming with ProfiTrace 2 only works under the following circumstances and settings:

Only Head Stations Type 1B or 1C with firmware V1.253 or higher

- Max. 1.5 Mbps (PROFIBUS)
- Clean TCP/IP connection
- ProfiTrace 2.6.0 or higher
- Only 1 ComBricks connection

After successfully installing ProfiTrace 2, you can find a '*ProfiTrace v2.x for ComBricks*' in the start menu of Windows (see Fig. 52).

This is the standard ProfiTrace2.exe, but with an additional parameter; ProfiTrace2.exe" - _CBMODE_

After Starting '*ProfiTrace V2.x for ComBricks*' ProfiTrace will initially look very similar to the regular version, but now with a reduced number of program option tabs offered near top of screen. The ScopeWare, Bargraph, Topology, ProfiCaptain and other tabs/menus are missing to the right of the single ProfiTrace tab (see Fig. 52).

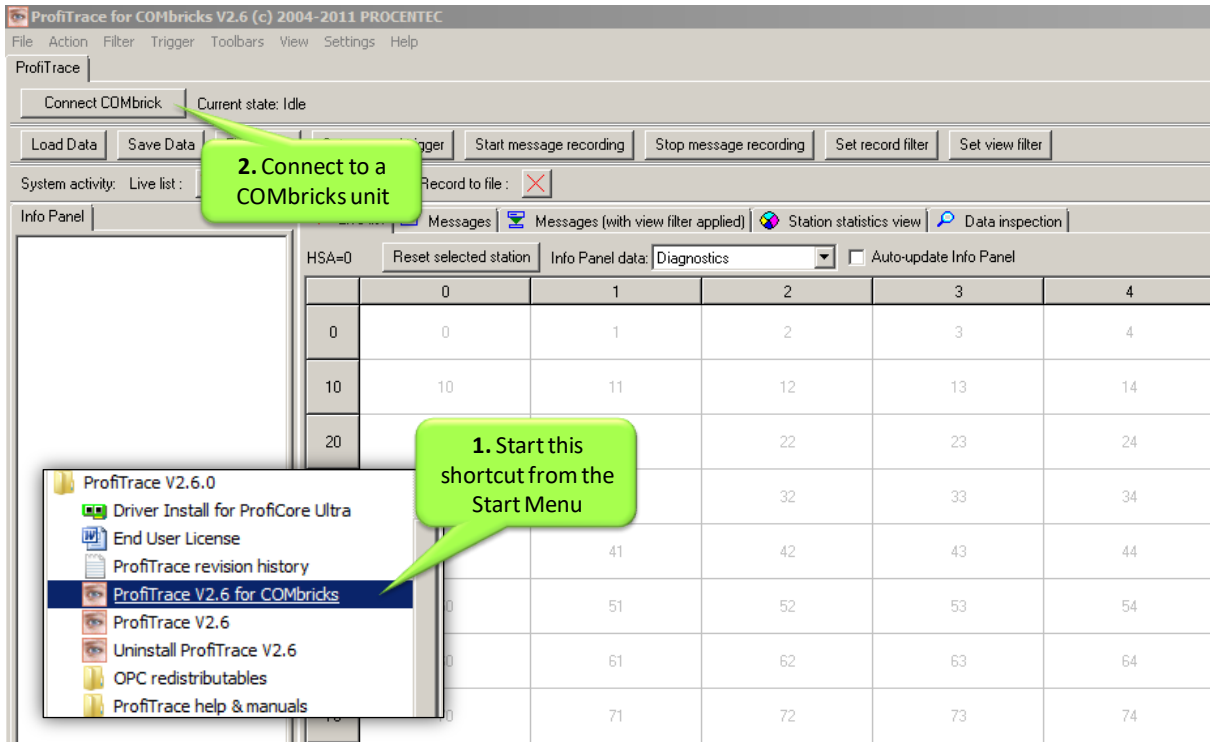

Fig. 52 - Starting ProfiTrace 2 for ComBricks

After clicking on the 'Connect ComBricks' button, a mid-screen dialogue window is displayed which is used to setup the connection with ComBricks (see Fig. 53).

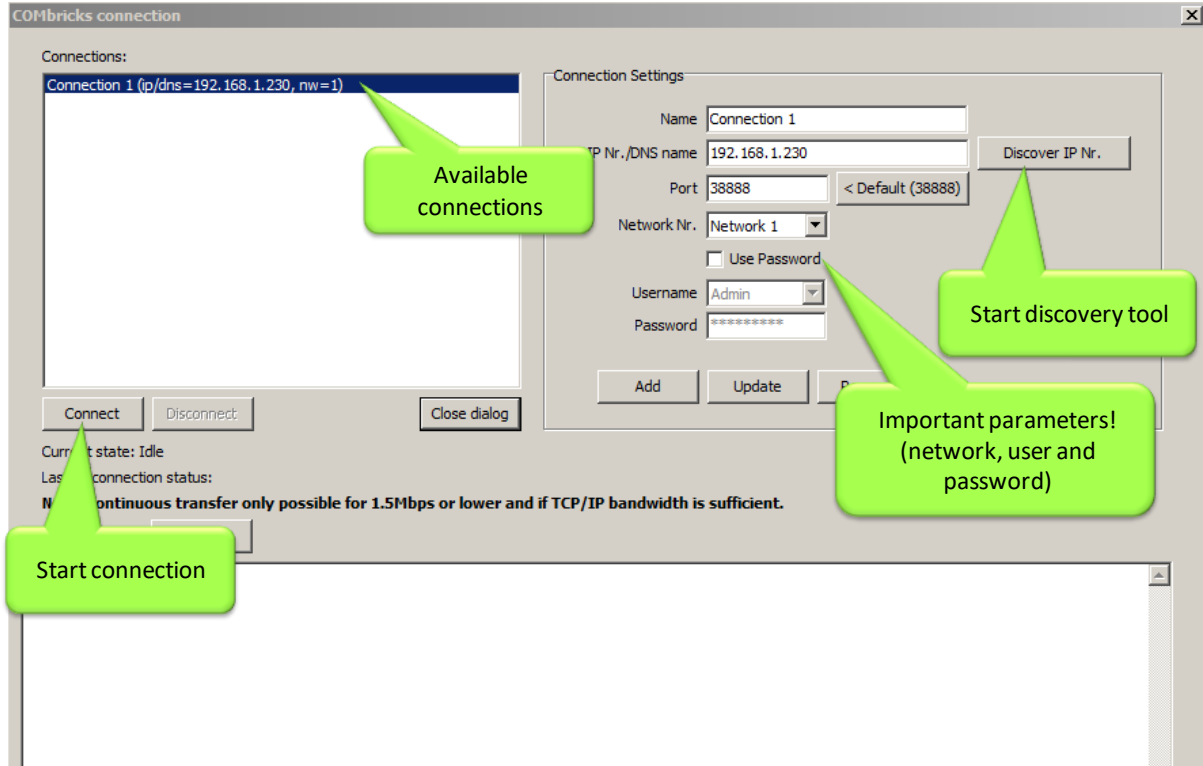

Fig. 53 - Setting up the connection

Important parameters for the connection and the streaming process:

- IP number
- User type and password
- Network number



If one of the connection parameters is incorrect, the connection will not be established or no data is streamed. It is recommended to start the discovery tool to verify the IP connection.

Multiple connection instances can be saved and loaded each with their own connection parameters.



ComBricks itself can handle 1 streaming connection, but on the PC multiple ProfiTrace instances can be opened that simultaneously communicate with different ComBricks units.

5.10 Summary of Statistics and Events

This paragraph contains a description of the items listed in the statistics and/or events.

Statistics	Description	Critical
Lost	<p>How many times a device in data exchange fails to respond after the maximum retries have been reached. Lost is retriggered when the device recovers back to data exchange and fails to respond again.</p> <ul style="list-style-type: none"> • Live List will indicate a yellow colored address (after time-out). • When the device was already lost after the activation of ProfiTrace Lost will not be updated. Only Syncs will indicate the problem. 	YES
Syncs	<p>Attempts of the master to contact a device for the first time or establish a communication relationship. This occurs in most cases after station lost, device unavailability or startup of the master. In the statistics view this values adds up relatively quick.</p> <ul style="list-style-type: none"> • Some DCS systems read diagnostics all the time with Syncs ON. • - Live List could indicate a yellow colored address. 	YES (in most cases)
Repeats Total	<p>Attempt of the master to get a response from an unanswered telegram. The response did not come or has content errors. The maximum amount of repeats a master attempts can be customized in the master.</p> <ul style="list-style-type: none"> • When the retries have reached the limit, the master goes to the Syncs state 	YES
Repeats Max (worst sequence)	<p>This value represents the highest amount of retries that were attempted on this specific device in one cycle.</p> <ul style="list-style-type: none"> • This value will never get higher than the retry value that has been setup in the master. 	YES
Illegal Responses	<p>The response to a master request telegram contains framing errors (parity error, wrong FCS, SD error, etc). This mostly happens with EMC and cabling problems.</p> <ul style="list-style-type: none"> • When this statistic adds up relatively quick, it could also be a double device address. 	YES
Internal Diag	<p>Negative responses at the lowest telegram level (Layer 2: FDL) and are rare. In the telegram recording you will see SD1 telegrams with for example an RS (Reject Service) or RR (Reject Resources).</p> <p>Examples of situations where this occurs:</p> <ul style="list-style-type: none"> • DP-V1 connections to DP-V0 devices. • Watchdog has run out on a DP device and the master sends a Data Exchange output telegram. • Non-certified DP devices that do not support a specific service/command or cannot handle a command in time. 	NO

Statistics	Description	Critical
External Diag	All responses from Get Diagnostics requests from all masters.	NO
Diag while in DX	<p>Only responses to Get Diagnostics requests from the master that controls this slave (primary class 1 master).</p> <ul style="list-style-type: none"> When the first 2 bytes of the diagnostic content contains a 08 0C or 08 04, a red indicator blinks in the left corner of the device in the Live List (critical content). 	YES (in most cases)
Master lost	One of the masters is not active after getting the token; it is not responding anymore. Note that this also happens when a Class 2 DP-V1 master is disabled.	YES (in most cases)
Baudrate change	The detected baudrate of the PROFIBUS network has been changed.	YES (in most cases)
Low/High signal (Bargraph)	At least one station has a too low (in DP and PA networks) or too high (in PA networks only) amplitude.	YES
Redundancy Failure	One of the redundant cables has failed.	NO
PA/FF signal and levels	PA or FF values such as jitter, DC voltage or DC noise out of range.	YES
High/Low signal Fiber Optic	Fiber Optic signal is out of range.	YES
Ring Failure (fiber optic)	Fiber Optic ring is broken.	YES

6 Head Station 1A/1B/1C

The Head Station is the primary element of ComBricks and has to be inserted in the most left slot of the fixed backplane socket. It schedules the interaction between all modules and provides data storage and an Ethernet interface for the user.



6.1 Overview

Type 1A is the basic model and ALL Head Stations are hardware technically identical with type 1A.

Type 1B and 1C are enhanced types that contain a ProfiTrace core and advanced web server for permanent remote maintenance of the PROFIBUS installation over Ethernet (hardware is identical as a type 1A).

- Type 1A: NO monitoring capabilities, no streaming, no OPC
- Type 1B: Monitors 1 PROFIBUS network + ProfiTrace 2 streaming + OPC (since June 2013)
- Type 1C: Monitors 4 PROFIBUS networks + ProfiTrace 2 streaming + OPC

For the monitoring with ProfiTrace OE, repeater modules or slave modules are required to provide PROFIBUS telegrams on the backplane network.

Head Station type 1B and 1C are able to stream live data directly in the ProfiTrace 2 software package over Ethernet. ProfiTrace 2 will run with full monitoring functionality and the user can benefit from its features.

The Head Station provides power to all modules through its redundant power supply.

Table 3 - Head Station comparison

	Head Station 1C (101-20011C)	Head Station 1B (101-20011B)	Head Station 1A (101-20011A)
Backplane networks (for repeater modules)	4	4	4
Web server	YES	YES	YES
CommDTM / Class 2 master	YES	YES	YES
SNMP	YES	YES	YES
ProfiTrace OE networks (for monitoring)	4 (ALL networks)	1 (network 1)	-
Oscilloscope features	YES	YES	-
ProfiTrace 2 live streaming	YES	YES	-
OPC	YES	YES	-

6.2 Relay contact

With the relay contact it is possible to react on an event (retries, lost, bus voltage too low, etc). It is also possible to control the relay manual or on a timer. Refer to **Paragraph 4.8** for details. The relay is capable of switching 0.5 A - 24 VAC.

6.3 SD card

The SD card is used to store ProfiTrace file recording data, logs, the GSD info file and backup settings.

By default a 1 GB SD card is supplied together with the Head Station, but it can be exchanged by an SD card with a maximum size of 32 GB.

The SD card is addressable directly with an FTP client. In the FTP software the SD card has a drive letter with a directory structure, on which files can be read and written from and to the SD card. When the password is set in the web server, this same password has to be used by the FTP software to establish a connection.

6.3.1 Inserting/replacing the SD card

The socket is located on the front plate of the Head Station.

To remove the SD card, gently press it inwards. The SD card is unlocked and released from the socket.

With insertion, just insert the SD card in the socket and press it inwards. The SD card socket has a polarity to make sure it is not inserted backwards.



The SD card is hot swappable, but there is a risk that monitoring data is lost when the system wants to write at exactly the same time as the removal or insertion.

6.3.2 Life cycle of the SD card

The life of a SD card depends on the following factors:

- Number of read and write operations
- Ambient temperature

At an ambient temperature of up to 60 °C the SD card has a service life of 10-years at maximum 100000 write/delete sequences.

If the maximum number of read and write operations has exceeded the limits, data loss may be possible.

6.3.3 Directories and files

The following directories have been standardized for ComBricks and are in most cases located on the SD card;

Directories	Description
/Busmon	ProfiTrace message recording files (Head Station type 1B and 1C only)
/Log	Log files
/Doc	Contains the web server download page (See Paragraph 4.11 on how to set it up)

Files and extensions	Description
Journal.DAT	System file (Do not delete or remove it)
GSD.BIN	File with GSD information for the Live List. (Generated with the ProfiTrace 2 software). See Paragraph 5.1.1 how to generate this file.
SETTINGS.INI	Head Station settings (IP address, name, location, etc.)
LICxxxxxx.TXT	License files
.PTC	ProfiTrace OE message recording files. (located in the "Busmon" directory). The files can be opened with ProfiTrace V2.5.3 and higher (See Paragraph 5.3 on how to generate PTC files).
.PKG	Firmware files
.CSV	Log files (located in the "Log" directory)

6.4 Audio jack

Not supported. This connector is removed from hardware versions higher than 1.5.

6.5 Switch navigation of the Head Station 1A/1B/1C

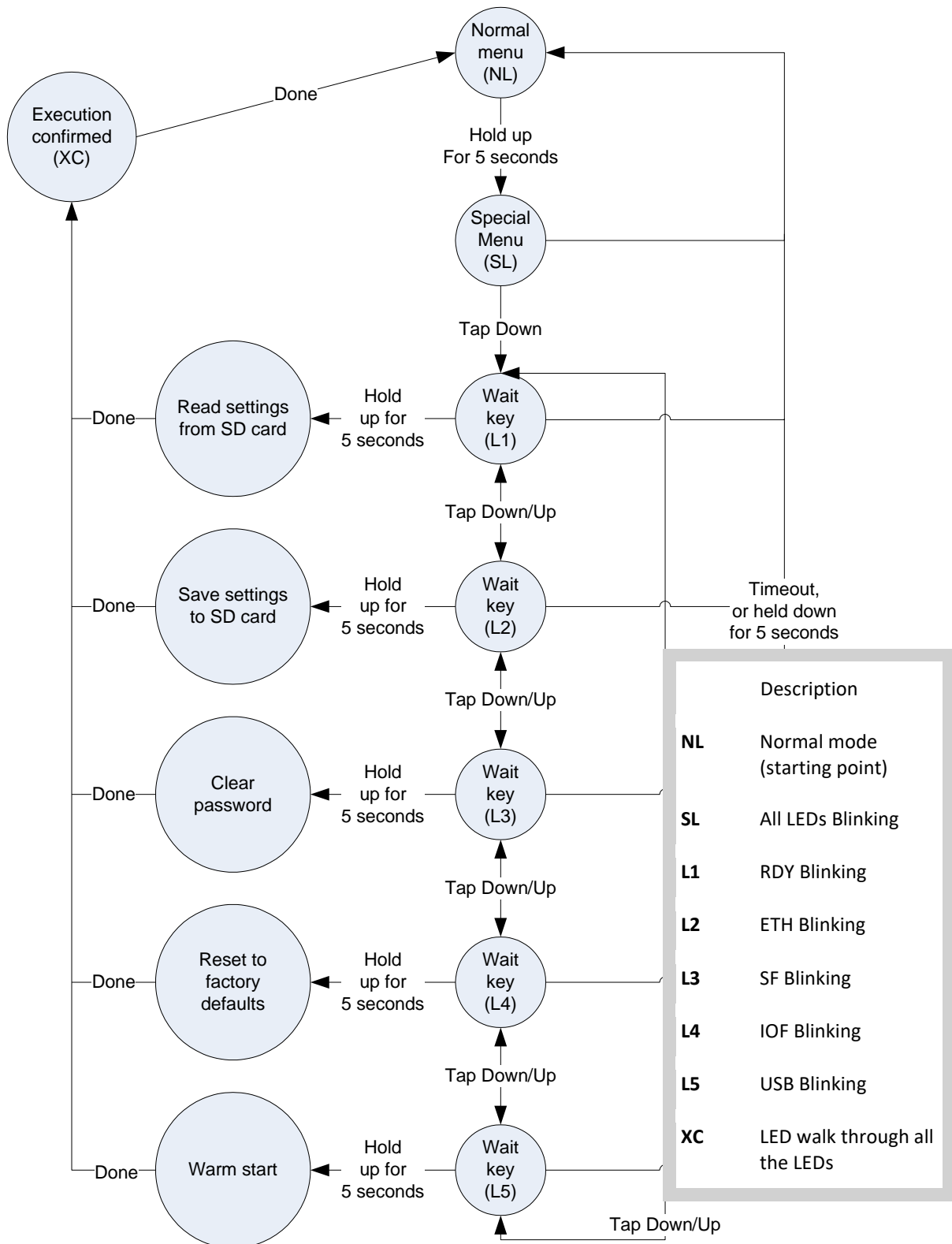

6.6 LEDs on the Head Station

In the tables below the LEDs of the Head Stations during normal operation are described. The LED conditions in firmware update and menu mode are not described here.

RDY - Ready	OFF	Blinking	ON
Starting up		X	
Run			X

ETH - Ethernet	OFF	Blinking	ON
No Ethernet link established	X		
DHCP configuration is pending		X	
Ethernet link established			X

SF - System failure on the Head Station	OFF	Blinking	ON
OK	X		
Backplane voltage too low (under 5,5 VDC) or current draw to high (above 2,5 A)		Fast	
Clock-chip error <i>(contact your local Distributor or PROCENTEC)</i>		Slow	
Internal component or firmware error <i>(contact your local Distributor or PROCENTEC)</i>			X

IOF - Failure on modules	OFF	Blinking	ON
OK	X		
High speed module in slot 11-32			X
More than 32 modules found			X
Module NOT identified			X

USB - Mini USB connecting	OFF	Blinking	ON
No USB connection	X		
USB connection			X

SD card	OFF	Blinking	ON
No SD card inserted	X		
SD card inserted (activity)		X	
SD card inserted (no activity)			X

7 Repeater modules (RS-485)

The standard RS-485 PROFIBUS repeater modules can be a 1 or 2 channel type. Suitable for 12 Mbps with screw terminals, additional DB9 connector, onboard termination, diagnostic LEDs and redundancy feature.

The advanced 12 Mbps core of the repeater module is identical as the ProfiHub and repeater B1; it can be cascaded unlimitedly and has increased RS-485 strength. It does not have the frustrating short-circuit bug and the bus communication is constantly monitored for glitches which are digitally filtered out. Every channel has on-board switchable termination and is able to drive 31 devices.

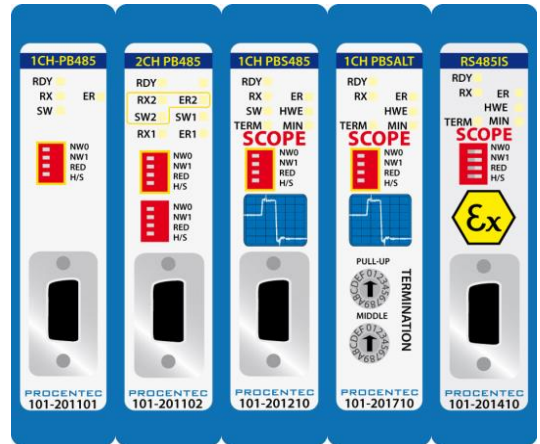

The repeater channels are directly connected with the ProfiTrace OE core in the 1B/1C Head Station. Busmonitor data is directly available in the web server.



10 Repeater modules can be inserted in the backplane. This is independent of the amount of channels on the repeater modules.



This chapter does not apply to the characteristics of the RS-485-IS Barrier module. It has been listed for comparison purposes only. For a detailed description of the RS-485-IS Barrier module, refer to chapter 8.

	1CH Repeater module (101-201101)	2CH Repeater module (101-201102)	1CH SCOPE Rep. (101-201210)	1CH SALT repeater module (101-201710)	1CH RS485-IS Rep. (101-201410)
Channels	1	2	1	1	1
Networks	4	4	4	4	4
Redundancy	YES	YES	YES	YES	YES
ProfiTrace (busmonitor)	YES	YES	YES	YES	YES
Oscilloscope (bus signals / bargraph)	NO	NO	YES	YES	YES
EMC and cable improving	NO	NO	NO	YES	NO
Intrinsically safe	NO	NO	NO	NO	YES See chapter 8

7.1 Multiple channels per module

Repeater modules contain 1 or 2 channels. **Fig. 54** illustrates a 2 channel repeater module. Every channel can be assigned to a specific backplane network by means of the NW dipo switches or the web server.



NOTICE:

Since March 2014 the 2 Channel modules are fitted with new, more robust screw terminals.

Old modules: The channels (CHx) have 2 screw terminals (IN and OUT, for the bus connection) and a termination switch.

New modules: The channels have 1 screw terminal and a termination switch. In most cases, the channel starts here so the termination must be set to 'ON'. If the channel is not the beginning, use the DB9 connector, see **paragraph 3.11.2**. Alternatively, use the dual ground clip (supplied with the new models) to install two cables in one screw terminal, see **Fig. 26**.

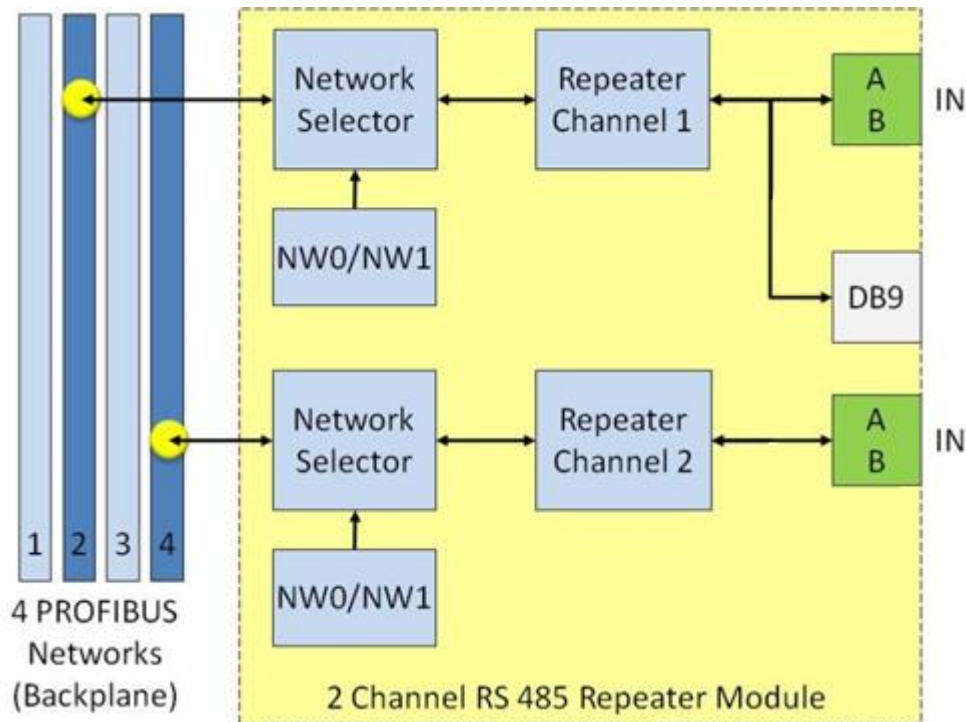

Fig. 54 - Multiple channels per module

ProfiTrace OE is able to monitor 4 PROFIBUS networks with 2 units of 2 channel repeater modules.

The DB9 connector is connected 1-on-1 to the connectors of channel 1 (see **Fig. 54**).

7.2 Channel structure

Every Channel is electrically isolated and internally connected to one of the transparent PROFIBUS networks on the backplane (see **Fig. 55**).

The shielding of the PROFIBUS cable can be directly grounded or indirectly grounded (see **Paragraph 7.4**).

The termination is switchable and powered by the repeater module. A LED on the front of the module or in the web server diagnostics indicate the status of the termination switch.



For the old models: When the termination is switched ON, the OUT connector of the specific channel is disconnected. If it is activated on Channel 1, the DB9 connector is NOT disconnected. In that case, check for possible termination errors. An extra termination on the connected plug could jeopardize the communication on the segment. See paragraph 3.11 for examples.

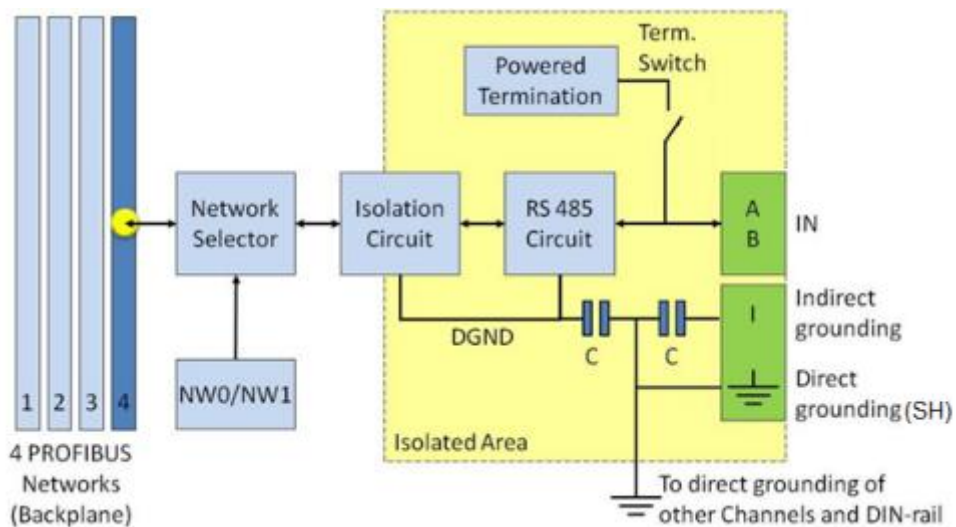

Fig. 55 - Channel structure of the repeater modules

7.3 EMC barrier

The galvanic isolation and bit recovery circuit in the repeater modules, make the ComBricks perfect to act as an EMC barrier for sensitive areas.

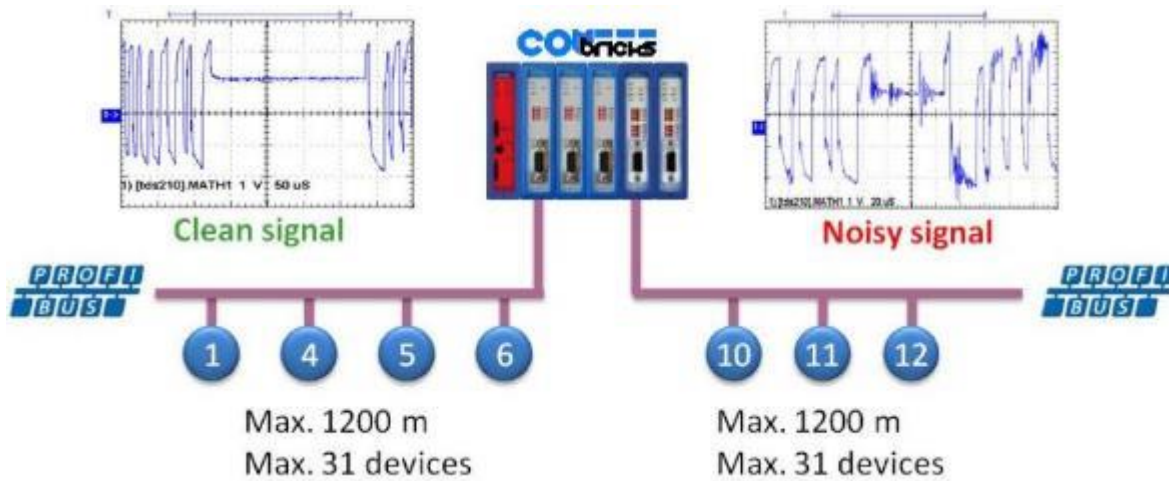

Fig. 56 - ComBricks as EMC barrier

7.4 Grounding system

There are 3 methods to ground the PROFIBUS cable:

- 1 Direct grounding
- 2 Indirect grounding (through a capacitor)
- 3 Combination of direct and indirect

In most cases it is recommended always to use Direct Grounding with the power supply and the shielding of the PROFIBUS cables. If you do not want to ground all or some cables to the common ground, the cable shielding should be connected to pin 'I'. A capacitor with a parallel high value resistor will separate the 2 potentials (see Fig. 55).

If the Direct Grounding is connected with the Indirect Grounding by mistake, the Direct Grounding "wins".

7.5 Baudrate detection

It takes less than 10 seconds for a module to detect the baudrate (in practice it will be around 3 seconds). The detection mechanism is started when telegrams enter the module from the field side (not the backplane). If the baudrate has been detected, the 'ER' LED will be OFF.

When the baudrate has been detected, the module has to "see" a valid telegram within 50 seconds, otherwise the module unlocks the baudrate and the 'ER' LED will be ON.

7.6 PROFIBUS DP cable lengths

The length of the PROFIBUS cable connected to the repeater channels should comply with the PROFIBUS DP cable specifications for RS-485.

Baudrate (kbps)	9.6	19.2	45.45	93.75	187.5	500	1500	3000	6000	12000
Segment length (m)	1200	1200	1200	1200	1000	400	200	100	100	100

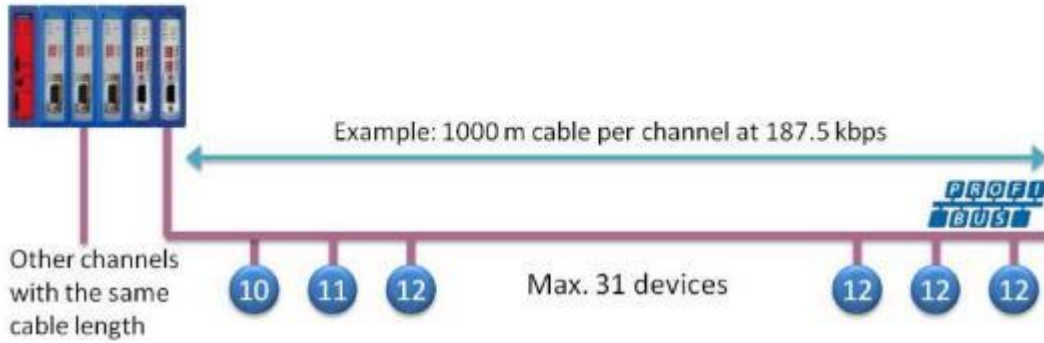

Fig. 57 - PROFIBUS DP cable lengths

7.7 PROFIBUS DP cable specifications

The cable should comply with the PROFIBUS DP cable specifications for RS-485.

Table 4 - PROFIBUS DP cable specifications

Parameter	Value	Parameter	Value
Wires	2 (twisted)	Wire diameter	≥ 0.64 mm
Impedance	150 Ohm (3 to 20 MHz)	Wire area	≥ 0.32 mm ²
Capacity	≤ 30 pF/m	Shielding resistance	≤ 9.5 Ohm/km
Loop resistance	≤ 110 Ohm/km		

7.8 PROFIBUS DP cable types

The repeater modules can handle PROFIBUS cable based on multiple protection sheaths with a diameter between 6 to 12 mm (when the grounding clip is used).

- Robust cable
- Food cable
- Ground cable
- Trailing cable
- Festoon cable
- Fire and heat cable
- Flexible cable
- Shipboard cable
- Rodent protection cable

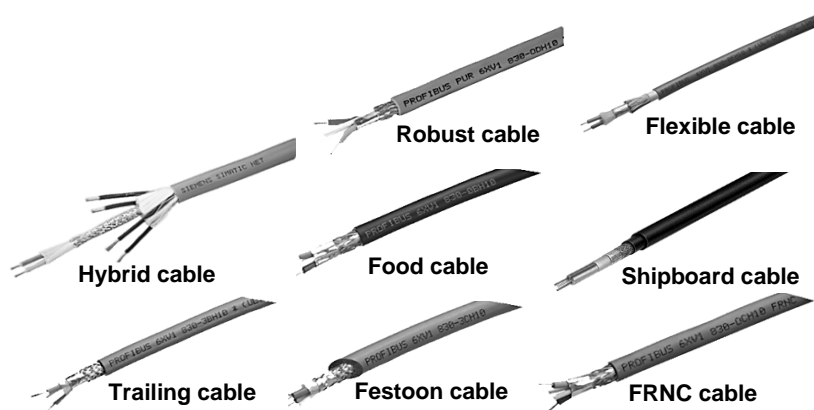

Fig. 58 - Supported PROFIBUS cable types

7.9 Redundancy

The bus redundancy technology of the repeater modules is very advanced. A redundant system can be built using 10 parallel cables. This architecture provides extremely high availability. It is compatible with the RLM01 from ABB.

The redundancy procedure is very simple;

All the repeater channels of the specific application have to be assigned to the same network group. The repeater channels that carry the redundant task have to be activated with the RED switch. After a reset or power-up the redundancy system works directly.

ComBricks locks itself to the first redundant channel that has a valid start delimiter.

If this channel does not have valid telegrams anymore, ComBricks locks itself to the next redundant channel with a valid start delimiter. There is no logic which redundant channel is selected.



It is recommended to use single-channel repeater modules for redundant applications. If a module should fail, the replacement (pull/plug and wiring) will not affect the other redundant repeater modules (channels).

Fig. 59 illustrates an application with 3 redundant segments. 3 Repeater modules of each ComBricks are set with the RED switch set to ON and are wired to the redundant segments.

The devices and the controller(s) are connected to the regular repeater modules. The maximum amount of devices which is allowed behind a regular repeater module depends on the application (between 1 and 31 devices).

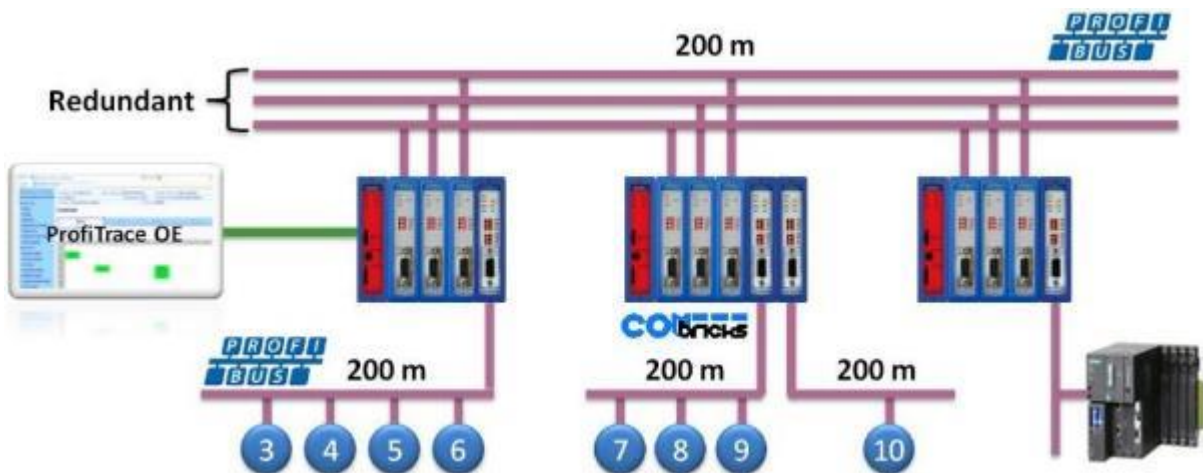

Fig. 59 - Application with 3 redundant segments

7.10 Mixing with other repeaters

Normally it is advised not to mix regular repeaters because of the limitation in cascading that these repeaters have (caused by the bit width alteration due to internal opto-couplers and digital electronics).

ComBricks regenerates the telegrams (same as a ProfiHub or B1 Repeater). This means there is just a small delay time, but no limitations in cascading.

If you mix ComBricks with other repeaters you only have to follow the cascading rules of the other repeater manufacturer. If the other repeaters are also from PROCENTEC, you can cascade and mix without problems.

Keep in mind that monitoring will fully work, but the SCOPE repeaters only measure the signals up to the first repeater module.

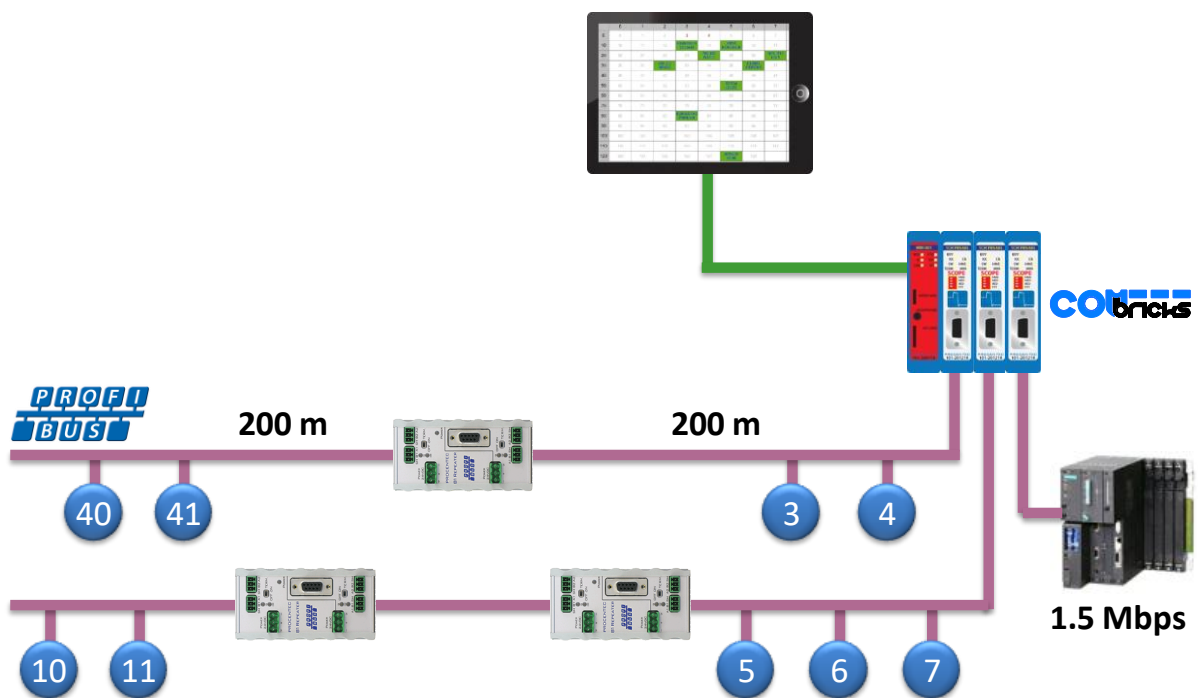

7.11 LEDs of the repeater module

The LEDs on the repeater modules are very useful for visual diagnostics.

Table 5 - LEDs on the standard repeater module















	OFF	Blinking	ON
RDY	 Repeater module has NOT been configured yet.	 Head Station is configuring the repeater module.	 Repeater module has been configured and is operational
RX	 NO valid telegrams detected on this channel.	 1 or more devices are communicating on this channel.	 1 or more devices are communicating on this channel.
ER	 The baudrate has been detected.	 Problem in the cabling has been detected on this channel.	 This channel has not detected the baudrate (yet) or there is a problem with the wiring of the cable.
SW	Internal termination for this channel is OFF.		Internal termination for this channel has been activated.

Table 6 - Additional LEDs on the SCOPE repeater module

	OFF	Blinking	ON
MIN	 Valid telegram signal amplitude (> 2.5 V)		 Telegram signal amplitude is too low (< 2.5 V)
TERM	 Valid idle voltage (~ 1 V).		 Idle voltage is too low (< 1 V)
HWE	 Repeater is operational.		 Internal repeater error (contact PROCENTEC)

8 RS-485-IS Barrier module

The ComBricks RS-485 Intrinsic Safety barrier is capable of creating segments for use in potentially explosive atmospheres. It complies with the specifications for PROFIBUS DP in IS segments and drives 31 RS-485-IS PROFIBUS DP devices. ProfiTrace and an Oscilloscope are integrated and also suitable for Intrinsic Safety.

The RS-485-IS barrier is the only available product for remotely monitoring IS segments over Ethernet from the safe zone. Because of the permanent mounting of the barrier, the user does not have to touch the installation anymore. This avoids hot permits and other paper work.

As an alternative it can also be used as a busmonitor on existing IS segments created by 3rd party barriers.

The IS barrier can be mixed on the backplane with other ComBricks modules, such as the PROFIBUS PA, Fiber Optic and regular RS-485 modules.

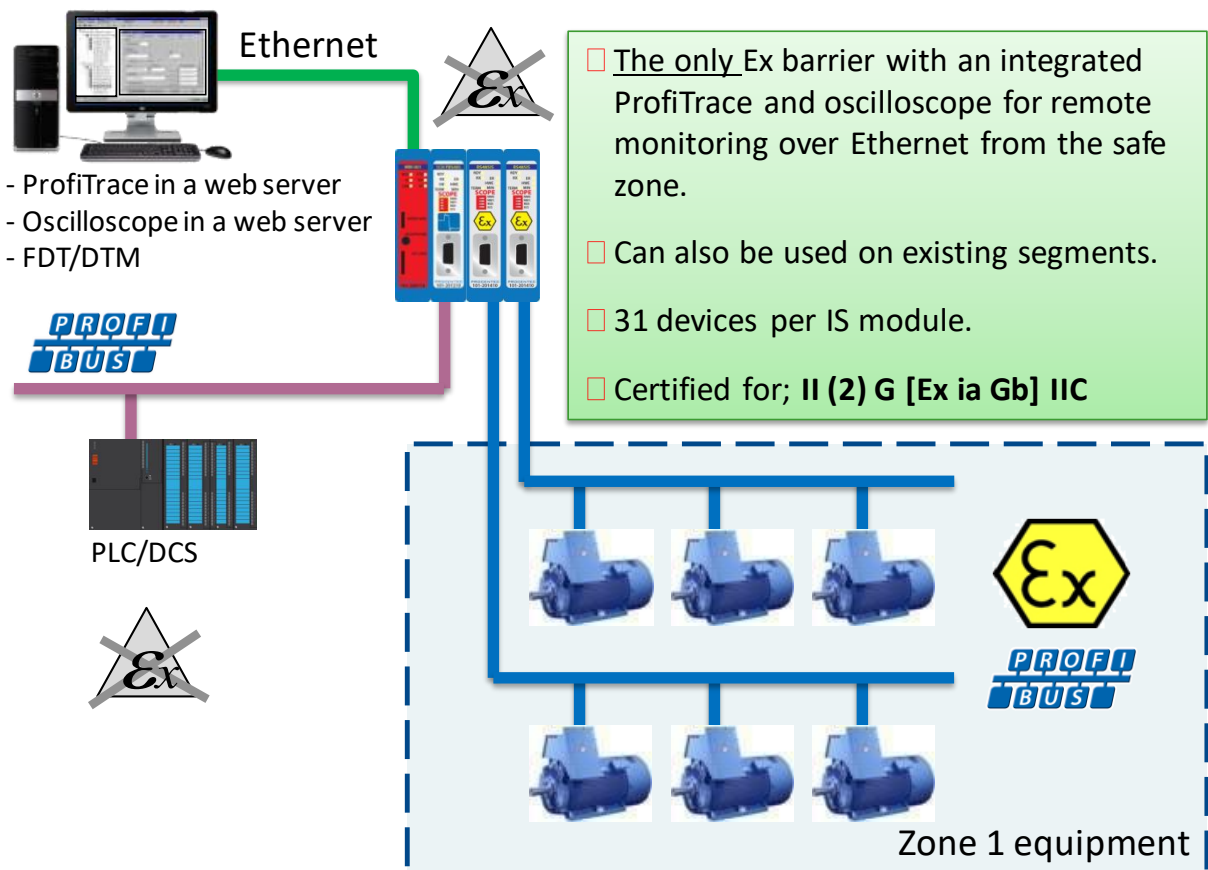

8.1 Compliancy and certificates

The RS-485-IS Barrier module complies with:

- ⚡ II (2) G [Ex ia Gb] IIC
- EN-IEC60079-0: 2009
- EN-IEC60079-11: 2012
- EN-IEC60079-25: 2010
- PROFIBUS International IS Installation Guidelines
- Certification number: DEKRA 12ATEX019



CERTIFICATE

(1) EC-Type Examination

(2) Equipment and protective systems intended for use in potentially explosive atmospheres - Directive 94/9/EC

(3) EC-Type Examination Certificate Number: DEKRA 12ATEX0192 Issue Number: 1

(4) Equipment: Profibus RS485-IS bus coupler Model COMbricks 1CH485-IS and Model COMbricks 1CH485-IS SCOPE

(5) Manufacturer: Exaton Delft B.V.

(6) Address: Rotterdamseweg 183C, 2629 HD Delft, The Netherlands

(7) This equipment and any acceptable variation thereto is specified in the schedule to this certificate and the documents therein referred to.

(8) DEKRA Certification B.V., notified body number 0344 in accordance with Article 9 of the Council Directive 94/9/EC of 23 March 1994, certifies that this equipment has been found to comply with the Essential Health and Safety Requirements relating to the design and construction of equipment and protective systems intended for use in potentially explosive atmospheres given in Annex II to the directive.

The examination and test results are recorded in confidential test report number 215498200.

(9) Compliance with the Essential Health and Safety Requirements has been assured by compliance with:
EN 60079-0 : 2012 EN 60079-11 : 2012

(10) If the sign "X" is placed after the certificate number, it indicates that the equipment is subject to special conditions for safe use specified in the schedule to this certificate.

(11) This EC-Type Examination Certificate relates only to the design, examination and tests of the specified equipment according to the Directive 94/9/EC. Further requirements of the directive apply to the manufacturing process and supply of this equipment. These are not covered by this certificate.

(12) The marking of the equipment shall include the following:



II (2) G [Ex ia Gb] IIC

This certificate is issued on 9 January 2013 and, as far as applicable, shall be revised before the date of cessation of presumption of conformity of (one of) the standards mentioned above as communicated in the Official Journal of the European Union.

DEKRA Certification B.V.

T. Pijper
Certification Manager

Page 1/2

⚠️ Illegal publication of this certificate and adjoining reports is allowed. This Certificate may only be reproduced in its entirety and without any change.
DEKRA Certification B.V. Utrechtseweg 310, 8812 AR Arnhem, P.O. Box 5165, 6802 ED Arnhem The Netherlands
T +31 26 3 52 20 00 F +31 26 3 52 58 00 www.dekra-certification.com Registered Arnhem 09085390



(13) **SCHEDULE**

(14) **to EC-Type Examination Certificate DEKRA 12ATEX0192** Issue No. 1

(15) **Description**

Profibus RS485-IS Bus Coupler Model COMbricks 1CH485-IS provides an intrinsically safe RS 485 interface for a COMbricks system, that consists of various modules, connected to a backplane that provides power and communication to the modules. The Bus Coupler provides galvanic isolation between the backplane and the RS 485 Profibus.

Profibus RS 485-IS Bus Coupler Model COMbricks 1CH485-IS SCOPE additionally provides an option to connect an oscilloscope to monitor the A and B lines of the RS 485 Profibus.

The Bus Couplers are intended to be installed outside the hazardous area or in an enclosure with a suitable type of protection.

Ambient temperature range -20 °C to +60 °C.

Electrical data

Supply and communication signals (backplane connector CN1):
 $U_n = 5,75 \text{ V}$
 $P \leq 3 \text{ W}$
 $U_s = 250 \text{ V}$

RS 485 Profibus Interface (front connector CN2):
 In type of protection intrinsic safety Ex ia IIC, with following maximum values:
 $U_0 = 4,2 \text{ V}$; $I_0 = 149 \text{ mA}$ (resistive); $P_0 = 115 \text{ mW}$; $C_0 = 6,8 \mu\text{F}$; $L_0 = 1,7 \text{ mH}$;
 $U_1 = 4,2 \text{ V}$; $C_1 = 0 \mu\text{F}$; $L_1 = 0 \mu\text{H}$.

The intrinsically safe RS 485 Profibus Interface complies with the specifications of clause 22.2.4 of EN 61158-2: 2010.

For a safe use of the Profibus RS 485-IS Bus Coupler, a reliable connection to the potential equalizing system shall be assured.

Installation instructions

The instructions provided with the equipment shall be followed in detail to assure safe operation.

(16) **Test Report**
No. 215498200.

(17) **Special conditions for safe use**
None.

(18) **Essential Health and Safety Requirements**
Covered by the standards listed at (9).

(19) **Test documentation**
As listed in Test Report No. 215498200.

Page 2/2
Form 100
Version 2 (2011-09)

Fig. 60 - Dekra ATEX Certificate

8.2 Channel structure

Every Channel is electrically isolated and internally connected to the transparent PROFIBUS networks on the backplane (see **Fig. 55**).

The shielding of the PROFIBUS cable is grounded 1-on-1 to the DIN rail.

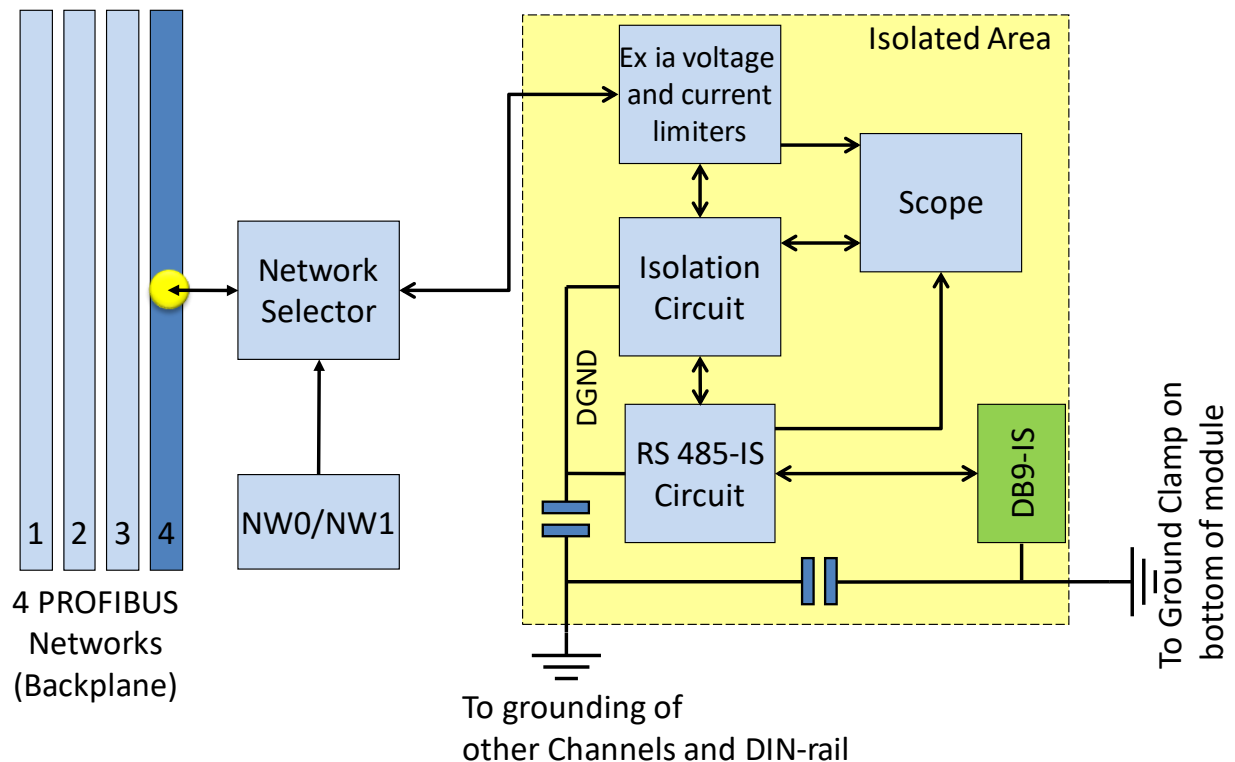

8.3 Connecting the cable

Connect the cable to the module with a DB9 connector on the front of the module. The DB9 connector must be suitable for use in Intrinsically safe networks, and the internal termination shall have a value of 200 Ohms.



Do not connect a cable which is connected to non-IS components. This will damage the internal electronics and makes the use of this module dangerous in Intrinsically Safe segments.

8.4 Grounding system

Always use Direct Grounding with the power supply and the shielding of the PROFIBUS cables. If you do not want to ground all or some cables to the common ground, the cable shielding should be connected to pin 'I'. A capacitor with a parallel high value resistor will separate the 2 potentials (see **Fig. 55**).

If by accident the Direct Grounding is connected with the Indirect Grounding, the Direct Grounding "wins".

8.5 Baudrate detection

Refer to **paragraph 7.5** for a description of the baudrate detection.

8.6 PROFIBUS DP cable lengths

The length of the PROFIBUS cable connected to the repeater channels should comply with the PROFIBUS DP cable specifications for RS-485-IS.

Baudrate (kbps)	9.6	19.2	45.45	93.75	187.5	500	1500
Segment length (m)	1200	1200	1200	1200	1000	400	200

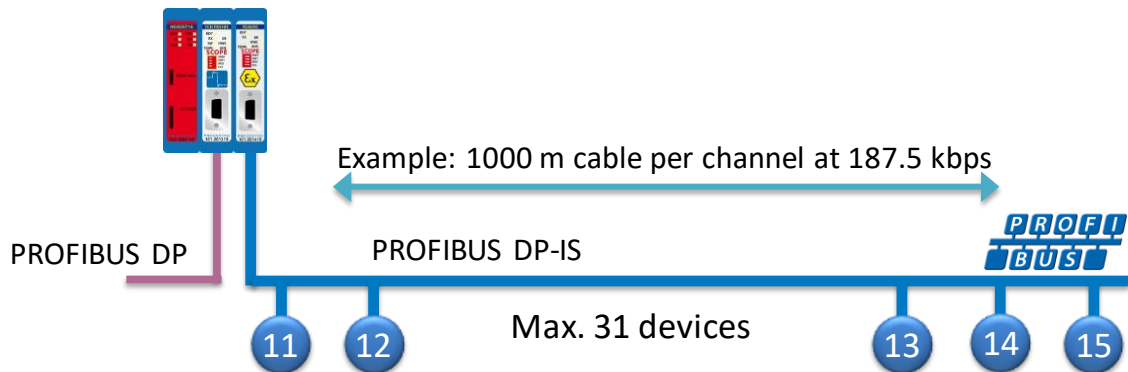

8.7 PROFIBUS DP cable specifications

The cable should comply with the PROFIBUS DP cable specifications for RS-485-IS.

Table 7 - PROFIBUS DP cable specifications

Parameter	Value	Parameter	Value
Wires	2 (twisted)	Wire diameter	≥ 0.64 mm
Impedance	135..165 Ohms at 3..20 MHz	Wire area	≥ 0.34 mm ²
Capacity	≤ 30 pF/m	Shielding resistance	≤ 9.5 Ohm/km
Loop resistance	≤ 110 Ohm/km		

8.8 LEDs and DIP switches of the repeater module

The LEDs on the repeater modules are very useful for visual diagnostics.

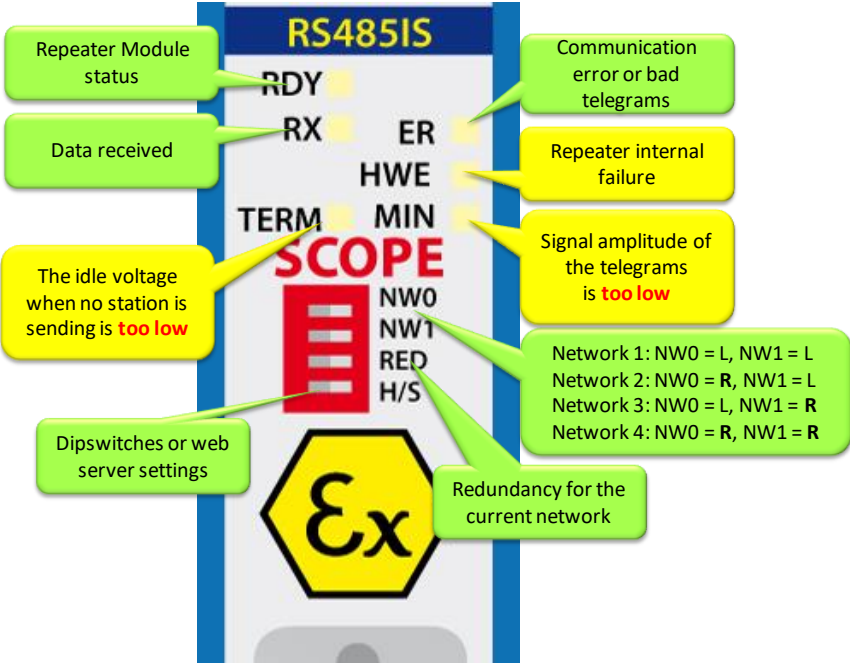

8.9 Redundancy

Refer to **paragraph 7.9** for a description of the redundancy system.

9 Fiber optic module (2FO-001)

The 2 channel PROFIBUS fiber optic module is suitable for 3 km multimode cable. This module enables long cable distances and a galvanic isolation between devices and segments. It can be deployed in a point-to-point, bus, star and hub topology.

The fiber optic modules can be placed side by side with repeaters modules. Just like any other communication module, the channels are directly connected with the ProfiTrace OE core in the Head Station. Busmonitor data is directly available in the web server.

ComBricks can easily be transformed to a fully dedicated fiber optic hub mixed with copper segments. The hub topology delivers an optimized delay time and live expansion.

The advanced 12 Mbps core of the fiber optic module can be cascaded unlimitedly with other fiber modules. It contains diagnostic LEDs and supports the redundancy feature. The fiber connection is utilized by 4 ST/BFOC connectors.

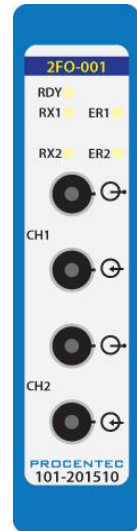

The 2FO-001 does not support ring redundancy. See **chapter 10** for modules that do support ring topologies.

9.1 Topologies

The ComBricks fiber optic module supports multiple topologies: point-to-point, bus, star and hub topology (see **Fig. 61**).

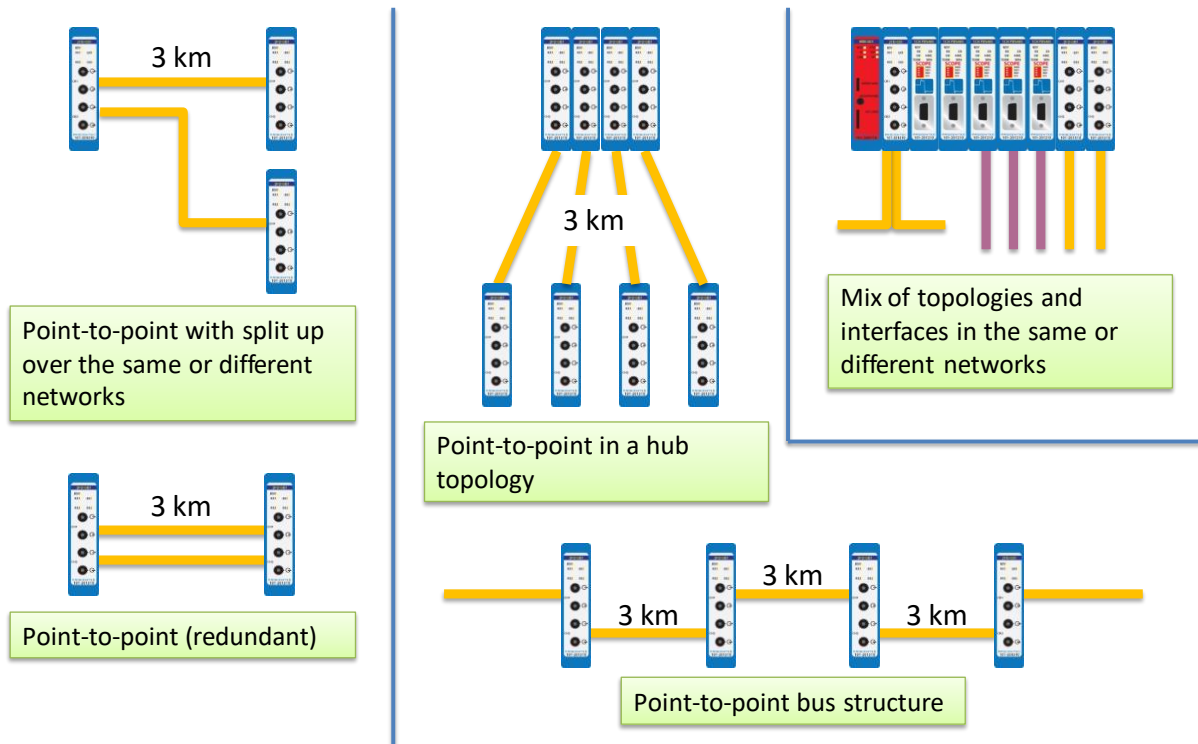

Fig. 61 - Fiber optic topologies

Fiber optic communication is in all situations point-to-point where the receiver and transmitter wires are crossed. The combination of modules can create complex topologies like; bus and star/hub topologies. Every topology has its own advantages and disadvantages.

9.1.1 Bus topology with ComBricks

- Long delay time
- Long range possible (cascading)
- Extendable only at the ends (without adding new modules)

9.1.2 Star/Hub topology with ComBricks

- Relative short delay time (no busparameter adjustments required)
- Adjustable at any time
- More module are required
- High availability

9.2 Delay time

Fiber optic applications require a delay time calculation to adjust the Slottime busparameter in the configuration of the master(s). ComBricks complies with the following formulas:

$$\text{FO cable delay} = (5 * 10^{-6}) \times \text{FO cable length} \times \text{Baudrate}$$

Example: 1.5 Mbps, 3 km FO cable

$$\text{FO cable delay} = 0.000005 \times 3 \times 1500000 = 22.5 \text{ TBit}$$

$$\text{Tdelay} = (\text{FO cable delay} + (2 \times \text{Module delay time})) \times 2$$

Continued example: 1.5 Mbps, 22.5 TBit FO delay:

$$\text{Tdelay} = (22.5 + (2 \times 1.8)) \times 2 = \mathbf{52.2 \text{ TBit}}$$

This is between 2 fiber optic modules! More calculations have to be done when more modules are involved (see **Fig. 62**).

The total delay for the entire network has to be added to the Slottime setting in the busparameters of the master.

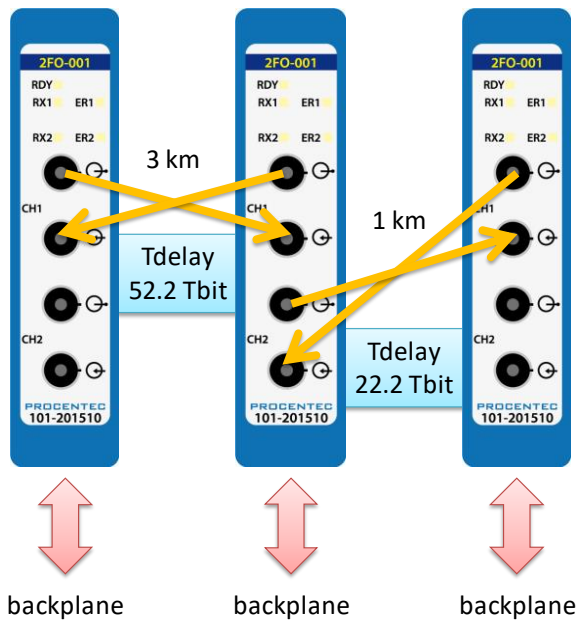

Fig. 62 - Fiber optic delay time

9.3 Baudrate detection

See **paragraph 7.5** for an explanation.

9.4 Fiber optic modules in redundancy mode

For correct pass-through of telegrams in redundancy mode, keep in mind that the delay time is longer in this mode. Increase the MinTSDR busparameter to at least 20 bittimes.

9.5 Use of FO modules in combination with other brands

When it is required that the ComBricks module connects to a third party optical link module, make sure to enable the 'Compatibility mode' on the third party optical link. This will ensure normal operation.

Furthermore, short FO cables can cause an optical overdrive in the receiving side of third party optical links. These links offer a 'reduced power' option to overcome this. The ComBricks does not suffer from the optical overdrive problem, and has no reduced power functionality. In rare cases, when very short cable is used, this can cause problems in the network. In these situations a 3dB attenuator should be used on the cable, or simply use a longer cable.

10 Fiber Optic Ring module (FOR-MM1 / SM1 / XM1)

The PROFIBUS Fiber Optic Ring module makes it possible to create reliable ring structured fiber optic connections over multimode, single mode or a mix of these modes. It is a galvanic isolation between devices and segments and can be used over long distances. It is even possible to create chain structured networks by using two or more modules in one ComBricks set.

The fiber optic ring modules can be placed side by side with repeater modules. Just like any other communication module, the channels are directly connected with the ProfiTrace OE core in the Head Station. Busmonitor data is directly available in the web server.

The use of mixed mode modules enables network designs with both multimode and single mode paths. When using the XM1 module, make sure to connect the multimode cable to channel 1 and the single mode cable to channel 2.

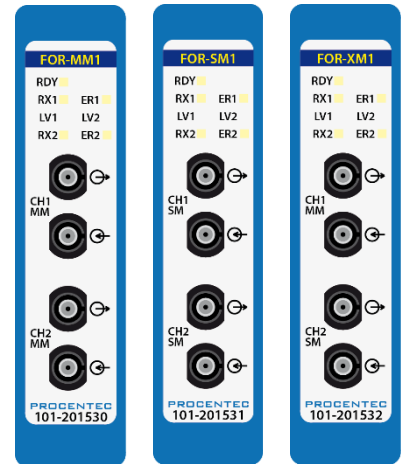

Firmware version v1.288 or higher is required to run these modules. Please update your firmware before using the Fiber Optic Ring modules.

10.1 Topologies

The ComBricks Fiber Optic Ring Module supports many topologies:

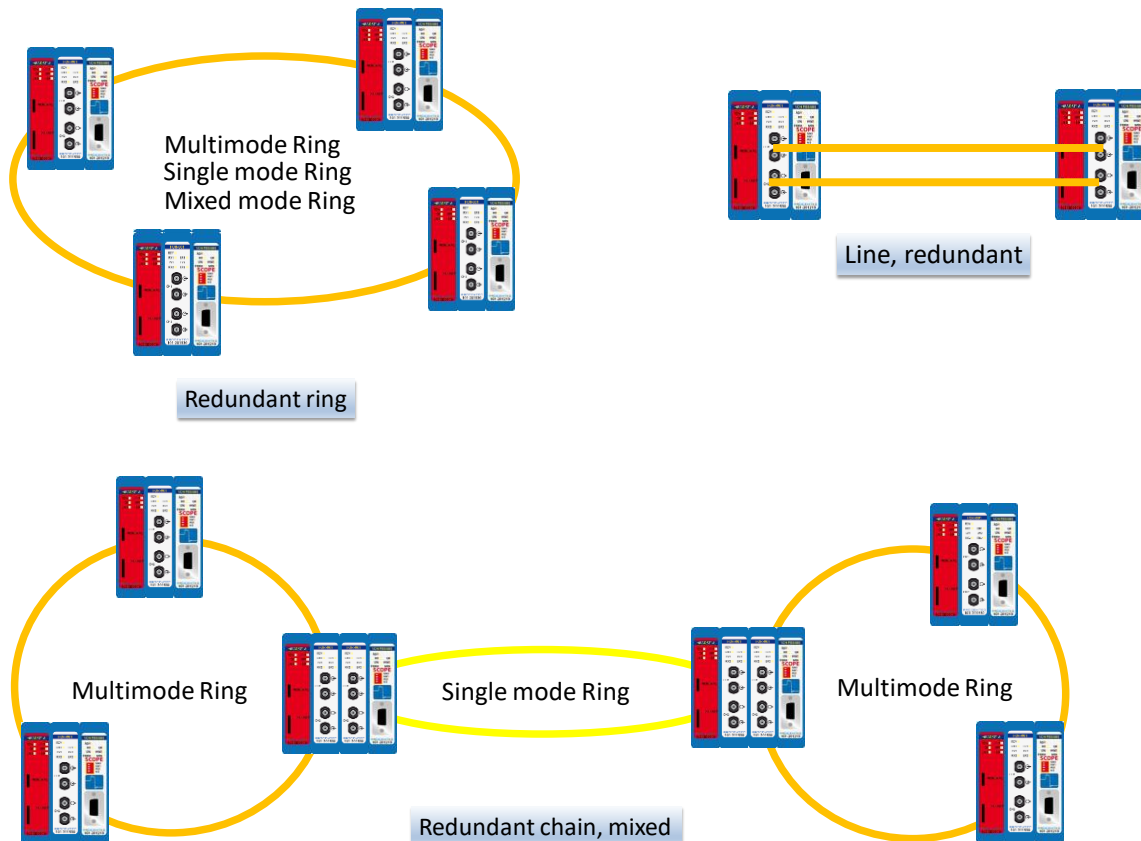

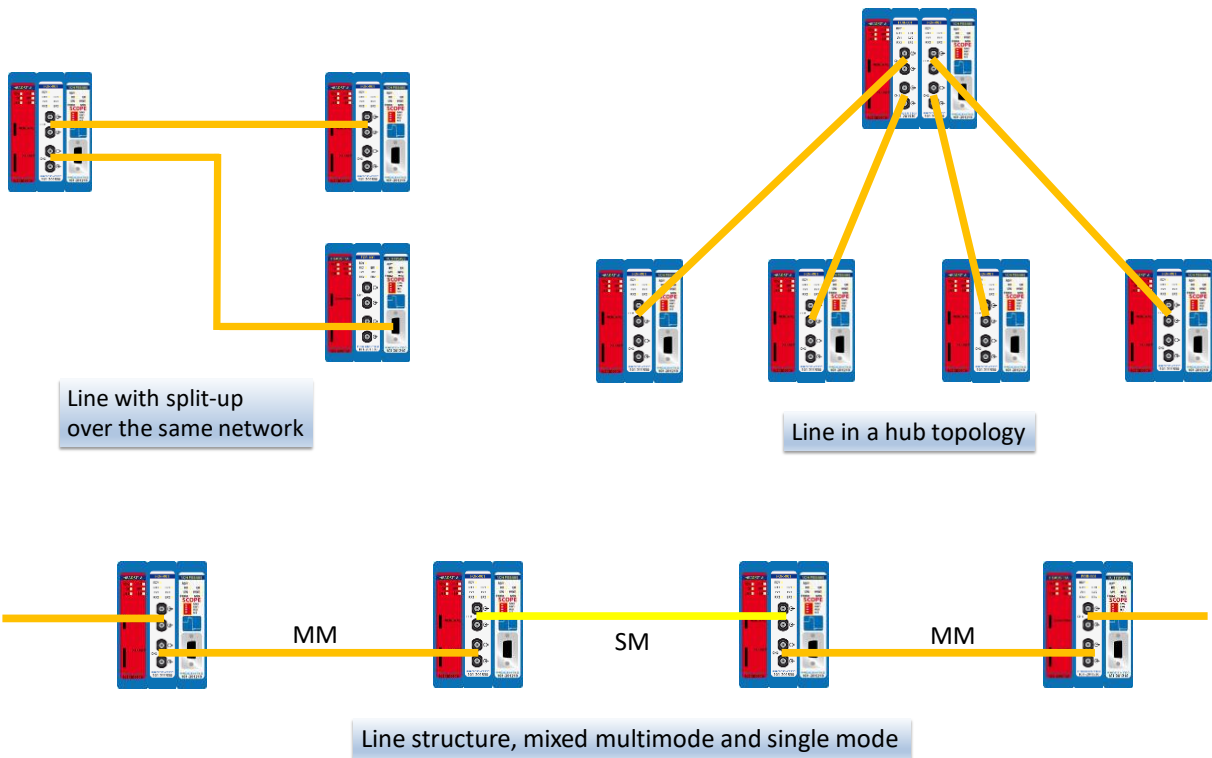

A ring topology must be connected from CH1 to CH1 and CH2 to CH2. Only with an uneven number of FO modules, the cables may be connected from CH1 to CH2 and CH2 to CH1 (only once per ring).

10.2 Delay time

Fiber optic applications require a delay time calculation to adjust the Slottime busparameter in the configuration of the master(s). To calculate the total delay including the fiber optic modules and extra time for ring events, use the following formula:

$$T_{\text{SLOT}} \geq \text{MaxTSDR} + (\text{FO}_{\text{length}} \times \text{FO}_{\text{delay}}) + (\text{N}_{\text{FO-modules}} \times \text{N}_{\text{delay}})$$

- FO_{length} = Total length of fiber optic cable in km
- FO_{delay} = Delay of fiber optic cable per km in bit times (see table)
- N_{FO-modules} = Number of fiber optic modules in ring
- N_{delay} = Delay of one fiber optic module (see table)

The above formula can be completed with the values in the following table:

Baudrate	Max _{TSDR}	FO _{delay} (in bit times)	N _{delay} (in bit times)
12Mbps	800	240	84
6Mbps	450	120	43
3Mbps	250	60	22
1.5 Mbps	150	30	12
500 kbps	100	10	6
187.5 kbps	60	3	5
93.75 kbps	60	2	5
45.45 kbps	400	2	5
19.2 kbps	60	1	4
9.6 kbps	60	1	4

The total delay for the entire network must be set as the new Slot time (T_{slot}) setting in the busparameters of the master.

Example 1: 1.5 Mbps, 5 km FO cable, 6 FO ring modules

$$\text{Max}_{\text{TSDR}} + (\text{FO}_{\text{length}} \times \text{FO}_{\text{delay}}) + (\text{N}_{\text{FO-modules}} \times \text{N}_{\text{delay}})$$

$$150 + (5 \times 30) + (6 \times 12)$$

$$150 + 150 + 72 = \mathbf{372 \text{ bit times}}$$

It is required to change the T_{slot} to a value higher than 372.

Example 2: 6 Mbps, 3 km FO cable, 10 FO ring modules

$$\text{Max}_{\text{TSDR}} + (\text{FO}_{\text{length}} \times \text{FO}_{\text{delay}}) + (\text{N}_{\text{FO-modules}} \times \text{N}_{\text{delay}})$$

$$450 + (3 \times 120) + (10 \times 43)$$

$$450 + 360 + 430 = \mathbf{1240 \text{ bit times}}$$

It is required to change the T_{slot} to a value higher than 1240.

10.3 Dipswitches

Use the DIP switches at the bottom of the module to change the behavior of the channels. The settings of these DIP switches are only read during startup of the module. The switches have the following values:

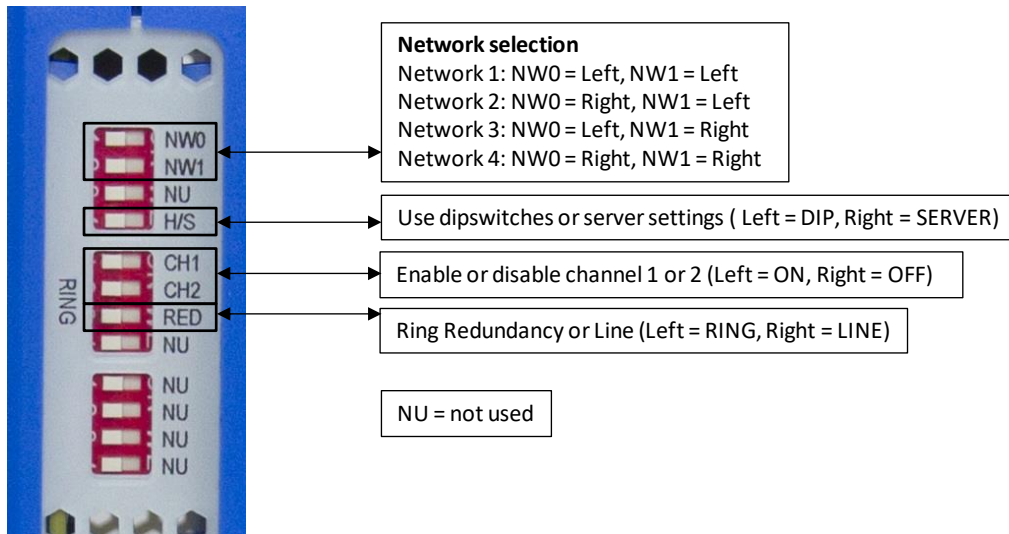

In all ring redundancy modes, the Ring dipswitches must be switched to the LEFT position.

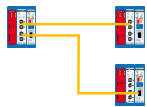
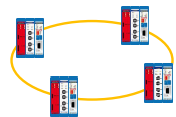











In case both channels are connected in line mode (to two different ComBricks FO modules), disable the RED switch (switch to RIGHT).

In case of one line connection, disable the RED switch (switch to RIGHT) and disable the unused fiber channel CH1 or CH2.



10.4 LEDs

The table below explains the function of all the LEDs on the front plate of the Fiber Optic module:

	OFF	Blinking	ON
RDY	 Module has NOT been powered / initialized yet.	 Head Station is initializing or updating the module.	 Module has been initialized and is operational
RX1 / RX2	 NO signal, or NO valid telegrams detected on this channel, or channel is off.	 1 or more devices are communicating on this channel.	 A fiber optic cable is connected and link is established correctly
LV1 / LV2	 Signal quality is good, or channel is off.	Not possible	 Low signal, received messages can still be decoded
ER1 / ER2	 No errors, or channel is off.	Not possible	 No baudrate detected or no connection/signal

10.5 Setting up Fiber Optic alarms

The webserver and the FO Ring module are capable of sending alarms on critical events in the fiber connection. The following events can be reported:

- Signal quality deterioration and quality improvement
- Ring failing and ring established

On the module status page all vital module information is displayed. You can see the detected baudrate, and channel 1 and 2 signal status. Also the ring status is displayed.

IP address: 192.168.11.29 MAC address: 9C:B2:06:00:09:CD System uptime: 7 days, 21:35:31
 Site: Mountain Tunnel Tube 2 Temperature: 42°C System time: 13-Mar-2015 9:21:26
 Company: Tunnel Inc. Country: Switzerland

Fiber optic module status

Module info	
Slot:	1 - FO Ring
Vendor:	PROCENTEC
Module type:	Fiber Optic Ring module Type 1
Serial number:	000011
Software revision:	V1.0.1
Hardware revision:	V1.0
Module status:	OK
Number of channels:	1

Channel 1	
Network:	1 (Right lane)
Baudrate:	1.5 Mbps
Station count active on channel:	1
Setting:	Dipswitch
Signal CH1:	● OK
Signal CH2:	● OK
Ring status:	● Ring OK

Signal and ring status

Signal CH1: ● Low signal Signal CH2: ● OK Ring status: ● Ring OK

Signal CH1: ● No signal Signal CH2: ● OK Ring status: ● Ring failure

These statuses are monitored by the ComBricks webservice and can be used as triggered events.

To set up the triggered event go to the 'Fiber optic config' page as shown in Fig. 63 and Fig. 64.

IP address: 192.168.11.29 MAC address: 9C:B2:06:00:09:CD System uptime: 7 days, 22:29:46
 Site: Mountain Tunnel Tube 2 Temperature: 42°C System time: 13-Mar-2015 10:15:42
 Company: Tunnel Inc. Country: Switzerland

Fiber optic configuration

Slot	Module	Variable	Current value	Settings
1	Fiber Optic Ring module Type 1 FO Ring	Signal port 1	● OK	Signal quality events: All changes Only on deterioration All changes Ring status events: Only on ring fail
		Signal port 2	● OK	
		Ring state	● Ring OK	

Save

Fig. 63 - Signal quality event setup

If the signal quality gets worse (due to cable or component aging, cable bends or dirt on the connector for example), this is a trigger. You can choose to have a trigger also on signal improvement; you can set this up in the configuration page. There are 3 levels for the signal event:

1. Signal OK
2. Signal low
3. No signal

If you choose 'All changes' in the Signal Quality Events setting, a transition between any of these stages will be triggered. Otherwise only a transition from (1 to 2), (1 to 3) or (2 to 3) will cause a trigger.

IP address: 192.168.11.29 MAC address: 9C:B2:06:00:09:CD System uptime: 7 days, 22:30:34
 Site: Mountain Tunnel Tube 2 Temperature: 42°C System time: 13-Mar-2015 10:16:30
 Company: Tunnel Inc. Country: Switzerland

Fiber optic configuration

Slot	Module	Variable	Current value	Settings
1	Fiber Optic Ring module Type 1 FO Ring	Signal port 1	● OK	Signal quality events: All changes
		Signal port 2	● OK	
		Ring state	● Ring OK	Ring status events: Only on ring fail Only on ring fail All changes

Save

Fig. 64 - Ring status event setup

If the ring fails, this is a trigger. You can choose to have a trigger also on ring reconnection. To set this up, choose 'All changes' in the Ring Status Events setting.

See **paragraph 4.8** and **5.4** for Output Control and Event Configuration to enable the Fiber Optic events.

11 PROFIBUS Slave Module PBS-001

The PBS-001 PROFIBUS slave module enables your ComBricks set with real Remote I/O capabilities. A unique feature is that it can also be used as a DP/DP coupler, a PB/PN coupler or gateway between multiple PROFIBUS and/or PROFINET networks.

The slave module can be placed side by side with any repeater module and can be used to control Digital Inputs or Outputs, or the relay card. The slave module has a PROFIBUS address, and busmonitor data is directly available in the web server of the Head Station.

It is possible to use the PBS-001 as a gateway between up to 10 PROFIBUS and/or PROFINET networks simultaneously. It transfers data on I/O level, which means that the master can be programmed to send data to the slave which is forwarded to another PROFIBUS or PROFINET module in the ComBricks backplane. Each module can transfer up to 64 words.

An additional benefit is that the DB9 connector of the PROFIBUS slave can be considered as a new segment. If the module is used with any another module on the same network number, then the signals coming out of the DB9 connector are re-generated in the PBS-001, in the same way as any repeater.



Make sure to update your PBS-001 module with the latest module firmware, and Head Station firmware 1.275 or higher. If an older firmware or GSD file is used, the module will not go into Data Exchange due to a parameter error. Please refer to **Chapter 17** for a guide to update your Head Station and module.

11.1 Status LEDs

The PBS-001 module has four diagnostic LEDs. These LEDs indicate whether the module is functioning properly.

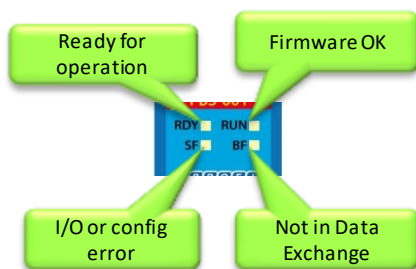

11.1.1 RDY LED

The RDY LED indicates power supply and connection with the Head Station. Also a firmware update is indicated with this LED.

LED	State	Meaning
RDY (green)	Off	No power supply, or PBS-001 module is faulty. There is no voltage at the module, or the module has a hardware defect. Remedy: Connect the 24 V DC supply voltage at the Head station.
	Flashing (1 Hz)	The PBS-001 module is connecting with the Head Station. This state is allowed for a short time (max 1 minute).
	Flashing (0.3Hz)	A backplane firmware update of the PBS-001 module is executed by the Head Station (max 1 minute).
	On	The connection with the Head Station is established.

11.1.2 PROFIBUS LEDs

The PBS-001 module has three PROFIBUS diagnostic LEDs: RUN, SF (System Fail) and BF (Bus Fail).

LED	State	Meaning
RUN (green)	Off	Internal application firmware is not running (PROFIBUS stack). Remedy: Update application firmware.
	On	Internal application firmware is running (PROFIBUS stack).
SF System Fail (red)	Off	No error
	On	System error, or the received expected configuration (from configuration tool) does not match the actual configuration (I/O modules in the backplane, or gateway has a problem).
BF (red)	Off	PBS-001 module is in Data Exchange with a PROFIBUS master.
	On	PBS-001 module is not in Data Exchange with a PROFIBUS master.

11.1.3 Dipswitches

The PBS-001 has four dipswitches, located on the bottom

of the module. See for a description of the dipswitches.

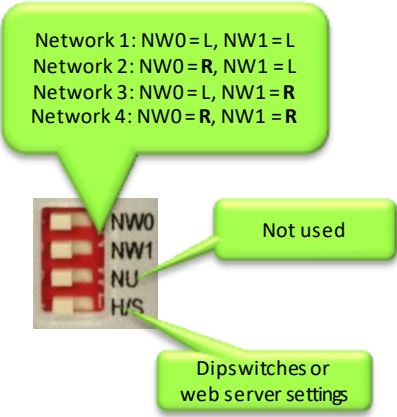

Fig. 65 - Dipswitch descriptions

11.2 Quick Start checklist

This checklist lists all the steps to a quick usage of the DP Slave module as a Remote I/O station.

- | | | |
|-----------------|---|---------------|
| STEP 1: | Provide the Head Station 1B or 1C with the latest firmware, at least v1.272. | (7) |
| STEP 2: | Add at least two empty backplane slots to the ComBricks set. | (2.2) |
| STEP 3: | Use the dipswitches on the bottom to assign the DP Slave module to the desired network. | (2.4) |
| STEP 4: | Assign a unique address to the module (either with rotary switches or software). | (11.3) |
| STEP 5: | Insert the DP Slave module in one empty slot. Do not insert it in slot number 11 or higher; this is not supported by the ComBricks. | (2.3) |
| STEP 6: | Insert a DI/DO/Relay card in the other empty slot. | (2.3) |
| STEP 7: | Provide power to the Head Station. | (4.2) |
| STEP 8: | Connect the Head Station to the Ethernet network with an Ethernet cable. | (4.2) |
| STEP 9: | Connect a DP cable to the DB9 connector, or make sure the module is assigned to another active ComBricks module. | |
| STEP 10: | Check the Channel List (in web browser) to see if the modules appear and check if the correct network and address is displayed. | (4.2) |

11.3 Setting up the slave module

Before inserting the module into your ComBricks set, first decide if you want to use the hardware address or if you want to use software addressing. Also decide to which network it listens by selecting the correct network number (see **paragraph 3.10.1**).

The baud rate cannot be set; the device detects the bus speed automatically.

If you wish to connect more than 4 networks, you need to make sure that these PBS-001 modules are not connected to one of the four available networks. The 5th up to (and including) the 10th module need to be set to 'Not Connected'. To do this, set the H/S switch to 'S', reset the module and browse to the web server of your ComBricks. In the left menu choose 'Network Config', open the drop-down menu in the column 'Set Network' and select 'N/C' which means 'Not Connected'. Then click 'Save & Apply now'. This enables you to connect up to 10 different networks. Please note that all PBS-001 modules which are 'Not Connected' cannot be analysed by ProfiTrace in the Head Station.

Slot	Module	Channel	Set by	Current Network	Current Redund.	Set Network (if Software)	Set Redund. (if Software)
1	PROFIBUS DP Slave Type 1 slot1	Ch 1	Software	1	Off	1	<input type="checkbox"/>
2	PROFIBUS DP Slave Type 1 slot2	Ch 1	Software	2	Off	2	<input type="checkbox"/>
3	PROFIBUS DP Slave Type 1 slot3	Ch 1	Software	3	Off	3	<input type="checkbox"/>
4	PROFIBUS DP Slave Type 1	Ch 1	Software	4	Off	4	<input type="checkbox"/>
5	PROFIBUS DP Slave Type 1	Ch 1	Software	N/C	Off	N/C	<input type="checkbox"/>
6	PROFIBUS DP Slave Type 1	Ch 1	Software	1	Off	1	<input type="checkbox"/>
7	Empty						
8	Empty						
9	Empty						
10	Empty						

Save Save & Apply now

11.3.1 Hardware addressing

Use the rotary switches on the bottom of the module to set the address. Make sure to use a suitable screwdriver to rotate the switches into the desired positions. The upper rotary switch indicates the value 10 times, the lower switch indicates its own value. The addressable range is 1 to 99. Examples:

Rotary 10x:	Rotary 1x:	Resulting address:
0	0	Software addressing (see 11.3.2)
0	4	4
3	6	36
9	9	99



Now the module can be inserted in an empty backplane slot as described in **paragraph 3.6**.

11.3.2 Software addressing

If you are using the software address, make sure the rotary switches are both set to 0. This enables a Class 2 Master to set the address with a telegram over PROFIBUS. The addressable range is 0 to 126 (where 126 is the default software address). The address is stored in non-volatile memory. When the module is power-cycled, the address will be loaded from non-volatile memory.

Use a configuration tool capable of sending “Set Slave Address” commands to change the address. Below is an example with ProfiCaptain:

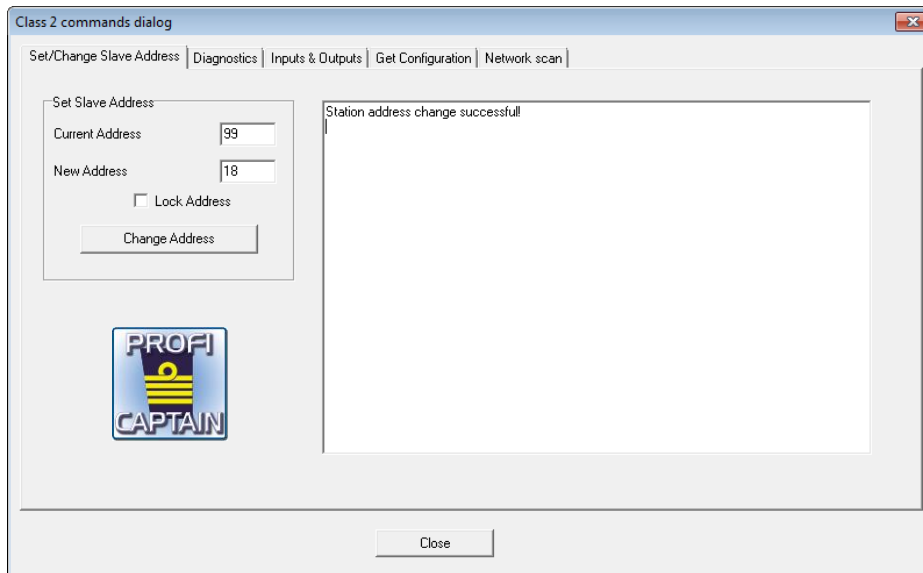

Fig. 66 - Software addressing of a slave

11.3.2.1 Locking the software address

The “Set Slave Address” command also has a ‘Lock’ feature (see **Fig. 66**). If you enable this feature, this locks the device for any new attempts to change the software address. Unlocking is only possible as described in **paragraph 11.3.2.2**.

11.3.2.2 Unlocking the software address

If the Lock feature was used in setting the address, the station address can only be unlocked if the PBS-001 is powered down and then powered up while the two rotary switches are NOT set to 0. This resets the software address to 126.

11.4 Remote I/O mode

After the module has been set up with an address, you can start configuring it in the network with the configuration tool of the PLC. Refer to the manual of the supplier of your configuration tool for instructions for that tool.

This example, a typical ComBricks setup with remote I/O, is built up as follows (see Fig. 67)

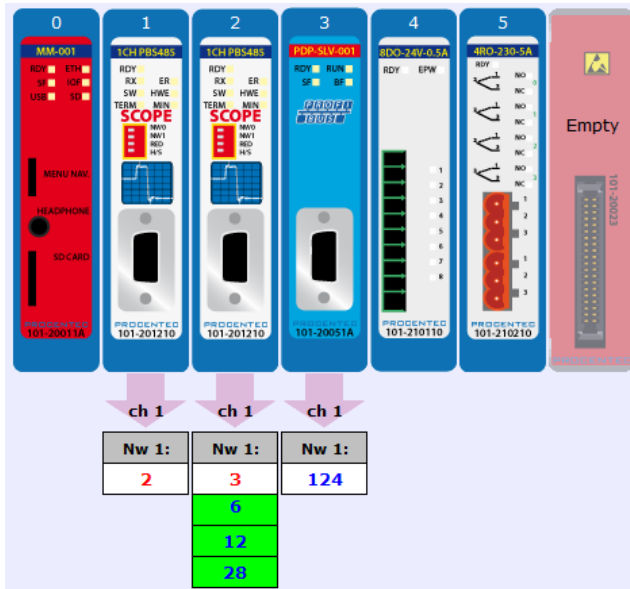

Fig. 67 - ComBricks configuration screenshot of the web server

The first two slots are occupied by Scope Repeater modules, then a Slave PBS-001, then an 8DO module followed by a 4 Relay module.

The slave has been assigned an address of 124 and is not in Data Exchange yet. The master that will control the PBS-001 is on the first Scope Repeater with address 2.

Open your configuration tool and insert/import the PBS-001 GSD with filename PROC696F.gsd (download it from www.procentec.com/gsd).

Then insert the correct modules into the configuration tool. In the first slots 1 and 2 insert two 'Empty Slots'. These are not really empty because they are occupied by Scope Repeater modules, but the PBS-001 cannot interact with them so they are considered to have no configuration.

In slot 3 place a PBS-001, in slot 4 an 8DO-24V-0.5A and the last module is the 4RO-230V-5A.

Fig. 68 shows the complete configuration for this ComBricks system.

Slot	DP ID	Order Number / Designation	I Address	Q Address
1	0	Empty Slot		
2	0	Empty Slot		
3	2	PBS-001		
4	194	8DO-24-0.5A	1	1
5	130	4RO-230V-5A		2
6				
7				

Fig. 68 - Configuration of the modules

ATTENTION: in some configuration tools, the slot numbers do **not** correspond to the slots displayed in Fig. 67. The modules are numbered from 0 instead of 1. This is not the case for all configuration tools. Make sure to check this before adding modules to your configuration.

Even if a mistake has been made in the configuration, for example the output cards have been switched, the slave will go into Data Exchange. It will generate an external diagnostics message (see Fig. 69) which can be captured and read with a busmonitor such as ProfiTrace (see Fig. 70).

103	104	105
113	114	115
123	PBS-001	125

Fig. 69 - Slave indicating External Diagnostics

```

PROFIBUS DP-V0 Message:
Get Diagnostics (Con/Res)
Status bits:
  Ext_diag_Bit
  Watchdog=on
Master_Add: 2
Ident_Number: 696F (hex)
Extended diagnostics: (18 bytes)
Contains 1 diagnostic block.
Block 0: Device related (18 bytes)
12 01 00 01 10 00 00 00
00 00 00 00 00 00 00 00
00 00
Additional diag. info: (from GSD)
General: Not Correct Module(s)
Slot 4: Not Correct Module
Slot 5: Not Correct Module

```

10
20
30
40
50
60
70
80
90

Fig. 70 - Diagnostics from the GSD in the Info Panel of ProfiTrace

11.4.1 Strict Check Configuration

This feature enables you to select if the slave should report a configuration mismatch, if this situation occurs. A configuration mismatch will take the slave out of Data Exchange. In the above example the slave was online and could send diagnostics. With Strict Configuration the configuration of the modules in the backplane must be exactly the same as the configuration in the PLC, or the slave will show up with a purple background in ProfiTrace as shown in **Fig. 71**. This feature gives you more control over how the slave behaves if a module is removed.

103	104	105
113	114	115
123	Config error	125

Fig. 71 - Slave indicating a configuration error or module mismatch with 'Strict check config' enabled

To activate this feature, go to the user parameter assignment of the PROFIBUS device in your configuration tool and change the value of the Strict Check Configuration from 'Disable' to 'Enable'. Remember to download the new configuration for the settings to take effect.

The slave will also generate diagnostics. These can be read as described in **Fig. 70**.

11.4.2 Failsafe behaviour of outputs



The functionality in this paragraph is only available for PBS-001 modules with software version 2.1 or higher. Please refer to **paragraph 17.2** for a guide to update your module. Use the correct GSD file.

In case of failure of the master, cable, ComBricks Headstation or backplane, the outputs of the ComBricks modules can be set to a failsafe state. This happens after a certain time-out period during which the slave did not receive any telegram from its master. This time-out is called the watchdog in the master configuration.

You can configure the failsafe behaviour in the 'module parameters' of the master configuration tool. The following options are available for fail-safe state:

- All outputs to 0x00 (off)
- All outputs to 0xFF (on)
- Keep last value (no change)
- Pre-defined value (configurable)

Open the properties of a ComBricks output module (generally by double-clicking on it) in the configuration tool and select 'Parameter Assignment' or 'Module Parameters'. A screen similar to **Fig. 72** will appear:

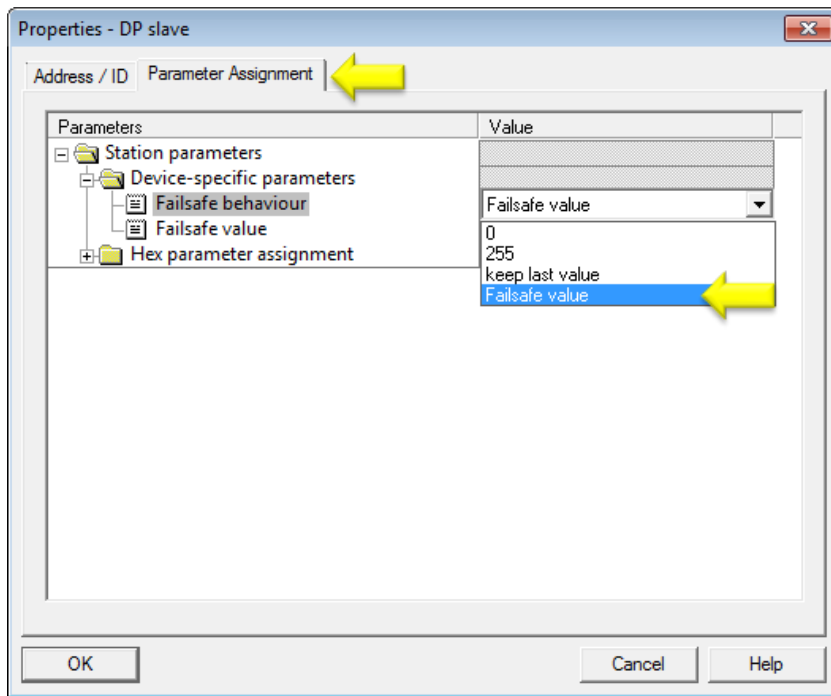

Fig. 72 - Parameter assignment window

After selecting 'Failsafe value' in the drop-down list, you can enter a decimal value of 0 to 255 in the Failsafe value box.

11.4.3 Input test patterns



The functionality in this paragraph is only available for PBS-001 modules with software version 2.1 or higher. Please refer to **paragraph 17.2** for a guide to update your module. Use the correct GSD file.

The input modules of ComBricks can be set to a test mode. Different test patterns can be generated automatically for testing purposes, for example during a commissioning or FAT/SAT phase, to see if the PLC is programmed correctly.

The following simulation patterns are available:

- On (all inputs to ON)
- Off (all inputs to OFF)
- Blinking (all inputs will blink, frequency is configurable)
- Up counter (inputs will increase, frequency is configurable)
- Down counter (inputs will decrease, frequency is configurable)
- Zig-zag (inputs will zigzag up and down, frequency is configurable)

Open the properties of a ComBricks input module (generally by double-clicking on it) in the configuration tool and select 'Parameter Assignment' or 'Module Parameters'. A screen similar to **Fig. 73** will appear:

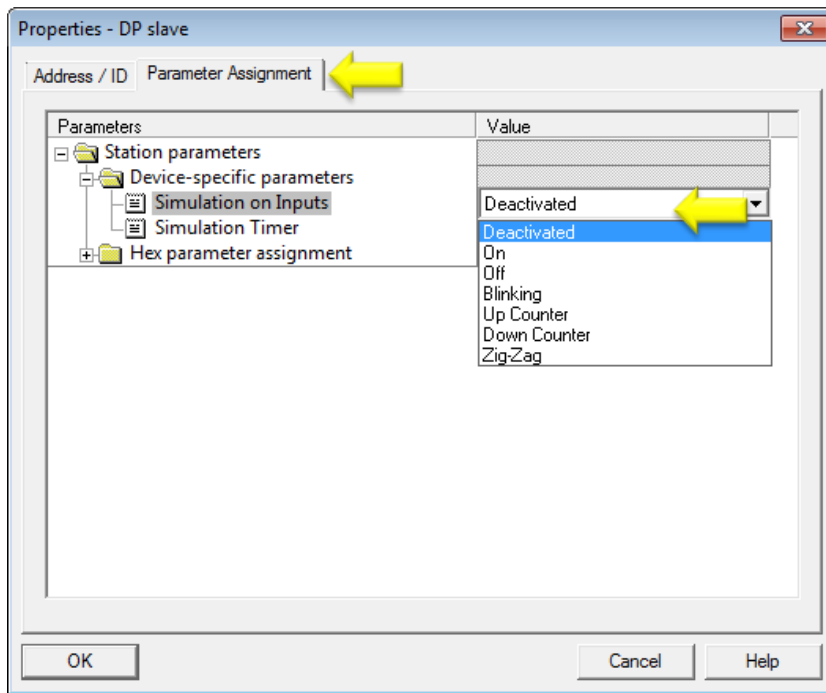

Fig. 73 - Input simulation window

After selecting a simulation pattern, you can enter a decimal value of 0 to 255 in the Simulation Timer box. This value indicates the waiting time in seconds before the input changes to the next value.

11.5 DP/DP coupling or Gateway mode

A unique feature of the PBS-001 is that it can be used as a DP/DP coupler for up to 10 networks, where each network can have different bus parameters and baud rates. It connects the networks on an I/O level, where you can decide how many bytes need to be transferred. For each network a PBS-001 is needed. So if you wish to connect 2 networks, you need 2 PBS-001 modules in one ComBricks set.

A typical ComBricks configuration for a DP/DP setup may look like **Fig. 74**:

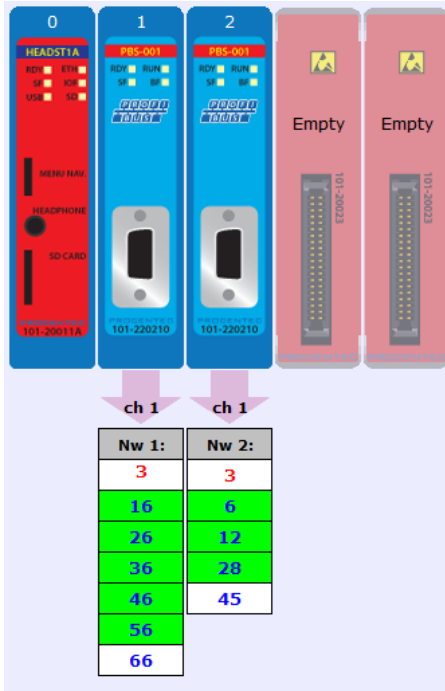

Fig. 74 - ComBricks configuration screenshot of the web server

Example layout

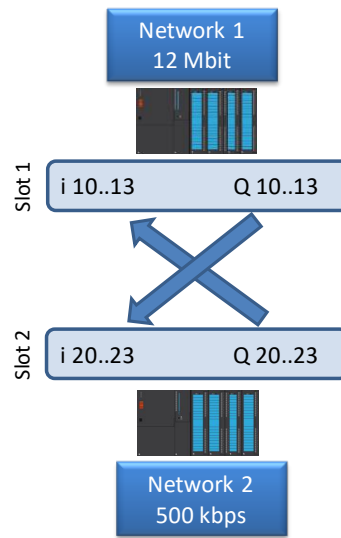

Fig. 75 - Schematic representation of the gateway

Slot 1 belongs to Network 1. Slot 2 is connected to Network 2. These networks can now be coupled via the configuration tools of each master. For example, if you want to transfer 4 bytes, the setup for the configuration tool of network 1 will look as follows:

Slot	DP ID	Order Number / Designation	I Address	Q Address
1	2	PBS-001		
2	194	004 byte IN/OUT PROXY	10..13	10..13
3				
4				

Fig. 76 - Configuration for Network 1

The first slot is used for the PBS-001 module. The next slot is used for another PBS-001 module, but a gateway module must be selected because the PBS-001 itself does not have any I/O.

The setup for the second network will look as follows:

Slot	DP ID	Order Number / Designation	I Address	Q Address
1	194	004 byte IN/OUT PROXY	20...23	20...23
2	2	PBS-001		
3				
4				

Fig. 77 - Configuration for Network 2

Now the Inputs and Outputs of both networks can be sent to the I/O of the gateways in the PLC program.

ATTENTION: in some configuration tools, the slot numbers do **not** correspond to the slots displayed in **Fig. 74**. The modules are numbered from 0 instead of 1. This is not the case for all configuration tools. Make sure to check this before adding modules to your configuration.

11.6 PROFIBUS / PROFINET gateway

The DP Slave module can also be used as a gateway to a PROFINET module. This works in the same way as the DP/DP coupler. Simply replace the second DP module for a PROFINET PND-001 module. Or extend the DP/DP coupler with a PROFINET module, as shown below. With this example you can exchange I/O from and to all networks. It is also possible to exchange data between more than 3 networks; up to 10 networks can be connected. It does not matter if these networks are PROFIBUS or PROFINET.

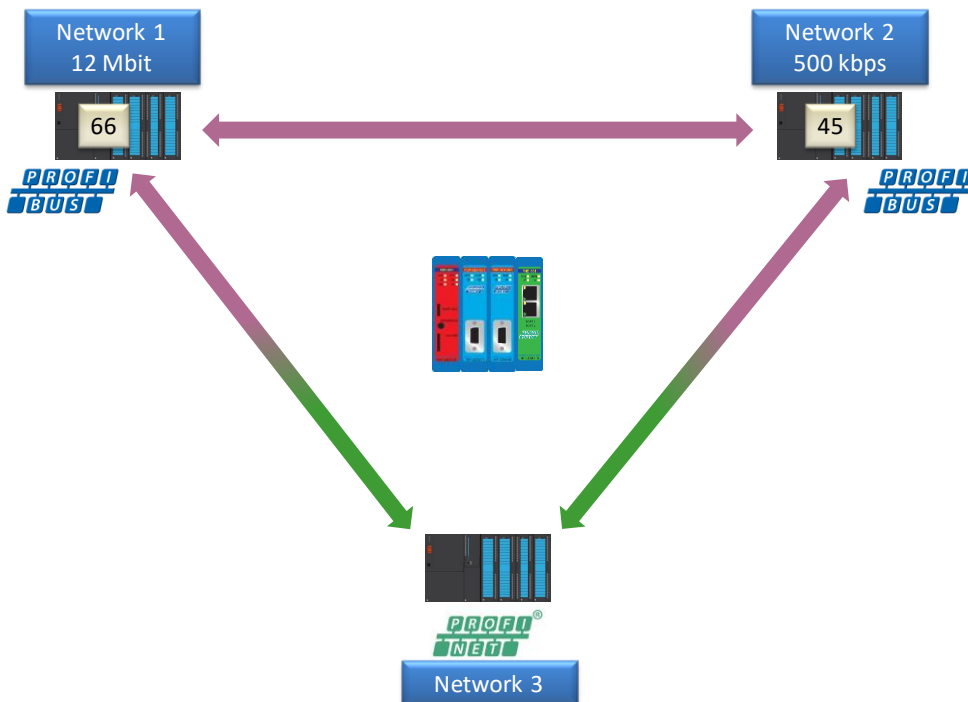

Fig. 78 - Example network layout of two PROFIBUS and one PROFINET networks

The configuration of the networks is as follows:

Slot	DP ID	Order Number / Designation	I Address	Q Address
1	2	PBS-001		
2	194	001 byte IN/OUT PROXY	4	4
3	194	001 byte IN/OUT PROXY	5	5
4				
5				

Fig. 79 - Configuration for PROFIBUS network 1

Slot	DP ID	Order Number / Designation	I Address	Q Address
1	194	001 byte IN/OUT PROXY	2	2
2	2	PBS-001		
3	194	001 byte IN/OUT PROXY	3	3
4				
5				

Fig. 80 - Configuration for PROFIBUS network 2

Slot	Module	Order number	I address	Q address
0	combricks	101-20011A		
X1	<i>FW-IG</i>			
1	001 Byte IN/OUT PROXY	101-220000	0	0
2	001 Byte IN/OUT PROXY	101-220000	1	1
3	PND-001	101-220110		
X1A	<i>Port 1</i>			
X1B	<i>Port 2</i>			
4				
5				

Fig. 81 - Configuration for network 3 (PROFINET)

Now the Inputs and Outputs of all networks can be sent to the I/O of the gateways in the PLC programs.

11.7 Data consistency

For some applications it is required to have consistent bytes, for example robot cells with X, Y and Z axis. The polling of I/O in the PBS-001 and the processing in the Head Station and PLC is asynchronous which can cause data inconsistency in the PLC, which means that not all bytes in a telegram are 'up to date'. The use of Consistent Gateways (defined in the GSD file) instead of normal Gateways offers a solution.

The paragraphs below describe a simple example of two PLC projects in Siemens Step7 which can be used in a real byte-consistent project. Example setup:

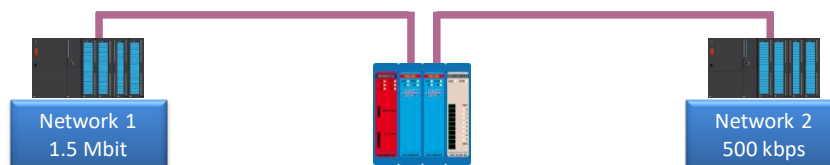

The example shows how to transfer consistent data from network 2 to network 1. If the data is consistent, nothing happens. If the data is not consistent, this is visualized by incrementing the outputs of the 8DO card (assigned to network 1).

11.7.1 Consistency over 2 bytes

Configuration of Network 1:

Slot	DP ID ...	Order Number / Designation	I Address	Q Address
1	2	PBS-001		
2	194	Consistent 002 B IN/OUT GATEWAY	0..1	0..1
3	194	8DO-24-0.5A	32	32
4				
5				

Data Block 1 of Network 1:

Address	Name	Type	Initial value	Comment
0.0		STRUCT		
+0.0	RCV_INCR_VALUE	BYTE	B#16#0	Received Variable increased
+1.0	RCV_MULTIPLY_VALUE	BYTE	B#16#0	Multiplied value
=2.0		END_STRUCT		

Organization Block 1 of Network 1:

```

L IN 0 //COPY 2 BYTES GATEWAY INPUTS TO DB1
T DB1.DBW 0

L DB1.DBB 0 //MULTIPLY RCV_INCR_VALUE * 3
L 3
+D
L 255
AW

L DB1.DBB 1 // LOAD RCV_MULTIPLY_VALUE
<D // COMPARE RCV_MULTIPLY_VALUE WITH RCV_INCR_VALUE * 3
JCN M004 // JUMP TO M004 IF CONSISTENT

L QB 32 // IF NOT CONSISTENT: OUTPUT BYTE 32 IS LOADED,
INC 1 // INCREMENTED,
T QB 32 // AND TRANSFERRED TO OUTPUT BYTE 32
M004: NOP 0 // NO OPERATION; NOTHING HAPPENS
  
```

Configuration of Network 2:

Slot	DP ID ...	Order Number / Designation	I Address	Q Address
1	194	Consistent 002 B IN/OUT GATEWAY	8..9	8..9
2	2	PBS-001		
3				
4				

Data Block 1 of Network 2:

Address	Name	Type	Initial value	Comment
0.0		STRUCT		
+0.0	INCR_VALUE	BYTE	B#16#0	Variable increased
+1.0	MULTIPLY_VAL	BYTE	B#16#0	Multiply Result
=2.0		END_STRUCT		

Organization Block 1 of Network 2:

```

L DB1.DBB 0 //INCREMENT INCR_VALUE
INC 1
T DB1.DBB 0

L 3
+D
L 255
AW
T DB1.DBB 1 //MULTIPLY_VAL = INCR_VALUE*3

L DB1.DBW 0 //COPY DB1 TO 2-BYTES GATEWAY
T QW 8
  
```

11.7.2 Consistency over 4 bytes

Configuration of Network 1:

Slot	DP ID ...	Order Number / Designation	I Address	Q Address
1	2	PBS-001		
2	194	Consistent 004 B IN/OUT GATEWAY	0..3	0..3
3	194	8DO-24-0.5A	32	32
4				
5				

Data Block 1 of Network 1:

Address	Name	Type	Initial value	Comment
0.0		STRUCT		
+0.0	RCV_INCR_VALUE	INT	0	Received Variable increased
+2.0	RCV_MULTIPLY_VALUE	INT	0	Multiplied value
=4.0		END_STRUCT		

Organization Block 1 of Network 1:

```

L ID 0 //COPY 4 BYTES GATEWAY INPUTS TO DB1
T DB1.DBD 0

L DB1.DBW 0 //MULTIPLY RCV_INCR_VALUE * 3
L 3
+D
L DB1.DBW 2 // LOAD RCV_MULTIPLY_VALUE
<D // COMPARE RCV_MULTIPLY_VALUE WITH RCV_INCR_VALUE * 3
JCN M004 // JUMP TO M004 IF CONSISTENT

L QB 32 // IF NOT CONSISTENT: OUTPUT BYTE 32 IS LOADED,
INC 1 // INCREMENTED,
T QB 32 // AND TRANSFERRED TO OUTPUT BYTE 32
M004: NOP 0 // NO OPERATION; NOTHING HAPPENS
  
```

Configuration of Network 2:

Slot	DP ID ...	Order Number / Designation	I Address	Q Address
1	194	Consistent 004 B IN/OUT GATEWAY	8..11	8..11
2	2	PBS-001		
3				
4				

Data Block 1 of Network 2:

Address	Name	Type	Initial value	Comment
0.0		STRUCT		
+0.0	INCR_VALUE	INT	0	Variable increased
+2.0	MULTIPLY_VAL	INT	0	Multiply Result
=4.0		END_STRUCT		

Organization Block 1 of Network 2:

```

L DB1.DBW 0 //INCREMENT INCR_VALUE
INC 1
T DB1.DBW 0

L 3
+D
T DB1.DBW 2 //MULTIPLY_VAL = INCR_VALUE*3

L DB1.DBD 0 //COPY DB1 TO 4-BYTES GATEWAY
T QD 8
  
```

11.7.3 Consistency over 8 bytes

Configuration of Network 1:

(10) PBS-001 PROCENTEC				
Slot	DP ID	Order Number / Designation	I Address	Q Address
1	2	PBS-001		
2	194	Consistent 008 B IN/OUT GATEWAY	0..7	0..7
3	194	8DO-24-0.5A	32	32
4				
5				

Configuration of Network 2:

(45) PBS-001 PROCENTEC				
Slot	DP ID	Order Number / Designation	I Address	Q Address
1	194	Consistent 008 B IN/OUT GATEWAY	8..15	8..15
2	2	PBS-001		
3				
4				

Data Block 1 of Network 1:

Address	Name	Type	Initial value	Comment
0.0		STRUCT		
+0.0	RCV_INCR_VALUE	INT	0	Received Variable increased
+2.0	DUMMY1	INT	0	dummy var
+4.0	RCV_MULTIPLY_VALUE	DINT	L#20	Received Result of multiplying *20
+8.0	MULTIPLY_VALUE	DINT	L#20	Received Variable increased *20
=12.0		END_STRUCT		

Data Block 1 of Network 2:

Address	Name	Type	Initial value	Comment
0.0		STRUCT		
+0.0	INCR_VALUE	INT	0	Variable increased
+2.0	DUMMY1	INT	0	dummy var
+4.0	MULTIPLY_VALUE	DINT	L#0	Result of multiplying *20
=8.0		END_STRUCT		

Organization Block 1 of Network 1:

```

CALL "DPRD_DAT"
LADDR :=W#16#0
RET_VAL:=M#0
RECORD :=F#DB1.DBX0.0 BYTE 8

L DB1.DBW 0 //DO OUR OWN CALCULATION
L L#20
*D
T DB1.DBD 8

L DB1.DBD 4 //COMPARE OWN CALCULATION WITH RECEIVED CALCULATION RESULT
L DB1.DBD 8
<>D
JCN M004 //JUMP IF CONSISTENT
L QB 32 //OUTPUTS ARE INCREMENTED IF NOT CONSISTENT
INC 1
T QB 32
M004: NOP
0

```

Organization Block 1 of Network 2:

```

L DB1.DBW 0 //INC DB0.INCR_VALUE
INC 1
T DB1.DBW 0

L L#20 // *20
*D
T DB1.DBD 4

CALL "DPRD_DAT" //call SCP 15
LADDR :=W#16#8 //start output address 128
RECORD :=F#DB1.DBX0.0 BYTE 8 //write data from data block to output address of I/O
RET_VAL:=M#0

```

12 PA Link/Coupler module

The transparent PROFIBUS PA link/coupler enables seamless high speed integration to PROFIBUS PA. It powers the attached PA devices and fully emulates them as DP devices on the backplane. Adjusted bus parameters are not required and therefore suitable for all DCS and PLC systems, even running on 12 Mbps.

The combined internal ProfiTrace and oscilloscope make this product extremely useful for remote maintenance over Ethernet. Jitter, noise, DC current, DC voltage, bar graph and oscilloscope, it is all there and easy to access. The free CommDTM allows access for asset management tools over Ethernet.

ComBricks is able to carry 9 PA links and an RS-485 or Fiber Optic module. It can also be a customized mix of PA modules with other communication modules. The PA link provides 500 mA current on a customizable bus voltage. The integrated PA termination is automatically activated when the module works as a link or coupler. It is switched off in the monitoring mode.

It does not require configuration and operates the same way as regular ComBricks repeaters. In the web server the behavior on the PA side can be set, like retries (default 5) and the watchdog (default 3 seconds). This product can directly replace 3rd party Non-Ex PA couplers/links and can be used as a monitor behind existing 3rd party Non-Ex PA couplers.



This module is not suitable for use in Ex environments unless a barrier is used between the PA module and the Ex zone.

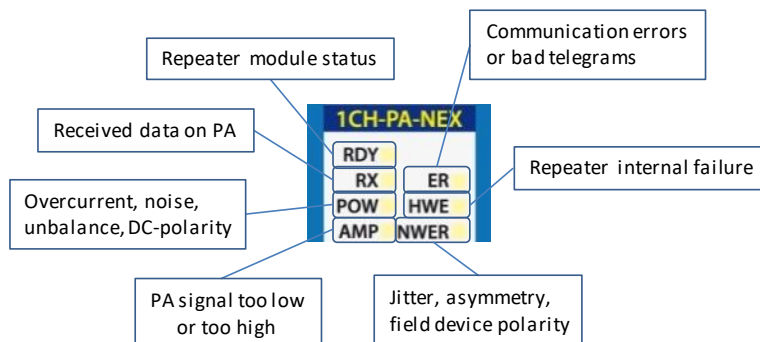

Fig. 82 - Overview of LEDs

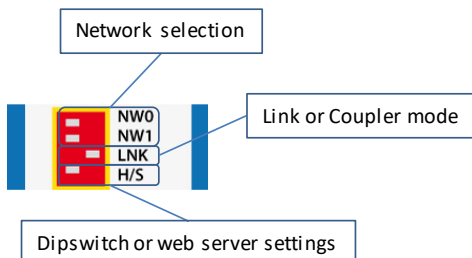

Fig. 83 - Overview of dipswitches

12.1 Quick Start checklist

This checklist lists all the steps to a quick usage of the PA module in Link or Coupler mode. It is assumed that a running ComBricks set with at least one DP repeater module or fiber optic coupler module is already active.

STEP 1: Provide the Head Station 1B or 1C with the latest firmware, at least v1.279. (7)

STEP 2: Add an empty backplane slot to the ComBricks set. (2.2)

STEP 3: Configure the PA module to the same network as a DP repeater module.
NOTE: for monitoring mode, use a different and unused network! (2.4)

STEP 4: Insert the PA module in the empty slot. (2.3)

STEP 5: Check the Channel List (in web browser) to see if the PA module appears. (4.2)

For Monitoring Mode: skip to STEP 8.

STEP 6: Power the top of PA coupler module. (2.6)

STEP 7: Check the status page of the PA module: is DC voltage OK?
Not too much noise on DC? Current consumption $\pm 10\text{mA}$? (12.2.1)

STEP 8: Connect the PA trunk cable with PA station(s). (12.5.1)

STEP 9: Check the status page of the PA module:
Current consumption increased? (12.2.1)

For Monitoring mode: Skip to STEP 11.

STEP 10: Use the GSD Converter to change the PA GSD files. (12.3.1)

STEP 11: Setup a master on the DP side. (12.4.1)

STEP 12: Check the Scope Signals of the PA trunk. (12.2.2)

12.2 Monitoring mode

If you have an existing PA network, you can add up to three PA modules as a monitoring and alarming tool. It measures telegrams and electrical signals which can be displayed in the web server. This is very similar to the standard Scope repeater card for PROFIBUS DP. The monitoring mode is enabled if:

1. No power is connected to the PA Power connector on the top of the module.
The internal termination is automatically switched OFF in monitoring mode.
2. The 3rd dipswitch (LNK) is set to OFF (left).



If the module is used in Monitoring Mode, make sure to set the Network Selection to a different network than networks already used by the ComBricks set. See **paragraph 3.10.1** for an explanation how to do this. If the module is set to the same network, all PA messages will also be transmitted on the DP network! This will cause errors.

12.2.1 Module status

The module status page in the web server displays the following useful status information, see **Fig. 84**

- DC voltage (measured PA bus voltage)
- DC plus and min value (measured PA plus and min voltages)
- DC noise (measured variation in DC voltage)
- DC unbalance (measured difference between +/- and shield)
- Current consumption (measured mA supplied to the PA network by the module)
- Hardware error LED status
- Amplitude error LED status
- Power error LED status
- Network error LED status

PA Oscilloscope module status	
Module info	
Slot:	4 - P4trunk to Tank4
Vendor:	PROCENTEC
Module type:	1 Channel PA-coupler 500mA Type 1
Serial number:	000068
Software revision:	V2.10.1
Hardware revision:	V1.3
Module status:	OK
Number of channels:	1
Link to oscilloscope images page:	Click here
Link to oscilloscope error images page:	Click here
Link config	
Link function:	On
Watchdog:	User defined
Retries:	5
Channel 1	
Network:	1 (Network 1)
Baudrate:	1.5 Mbps
Station count active on channel:	2
Link function:	On
Setting:	Dipswitch
DC voltage:	23.50 V
DC plus:	12.16 V
DC min:	-11.34 V
DC noise:	38 mV
DC unbalance:	-7 %
Current consumption:	32 mA

Fig. 84 - PA Oscilloscope module status

To view the page above, click on 'Status' in the upper left corner and then the appropriate PA module.

12.2.2 PA oscilloscope images

The PA module has an integrated oscilloscope to measure the signal quality of the telegrams. The oscilloscope has an interface with the web server to display the signals from the devices which are connected to its channel. After opening the web page, all oscilloscope signals are displayed and updated live (see Fig. 85). By default one scope image is updated every second. This can be adjusted in the General Config page (see paragraph 4.5).

Click the button 'Reset oscilloscope images' to delete all scope images from memory. If the red 'AMP' LED on the PA module was on, this will be switched off. If the values are still not good, the LED will remain on.

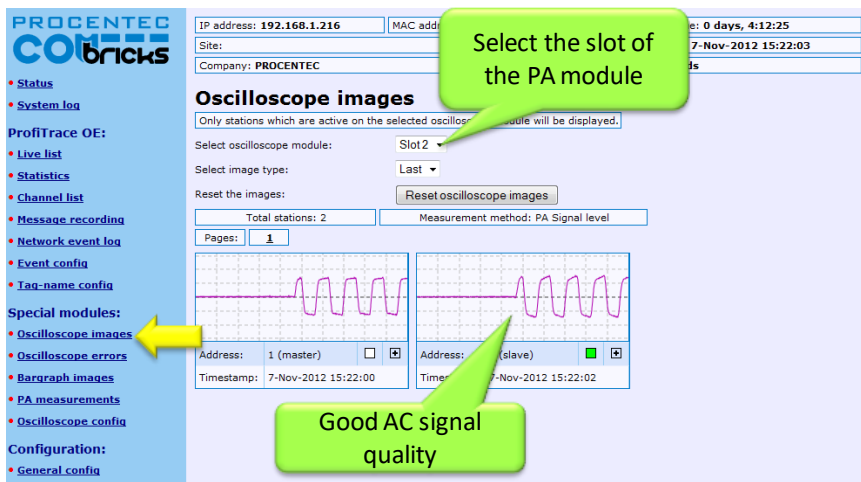

Fig. 85 - Oscilloscope images

12.2.3 PA Bar Graph

The Bar Graph illustrates the average AC signal strength from all available connected devices connected to the PA segment. It is a helpful utility to get an impression of the overall signal quality of the network (see Fig. 86).

The average amplitude should be around 750mV. When there are bus problems the Bar graph will display different Voltage levels and the color of the bars will change if the minimum or maximum level has been reached. These levels can be adjusted in the 'Oscilloscope Config' menu (see chapter 12.2.5).

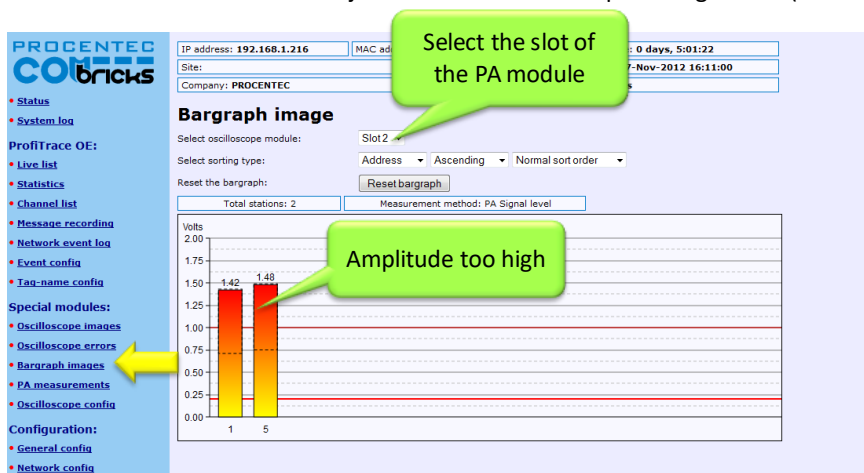

Fig. 86 - Bargraph image for PA

In the above example the amplitude is too high due to missing termination on one side. Normally the amplitude should be between 750 and 1000 mV.

12.2.4 PA measurements

The PA measurements page shows a static scope image; it is not an actual scope measurement. The blue arrows illustrate the measured value of the amplitude and the jitter. The values are displayed in the corresponding boxes (see Fig. 87).

12.2.4.1 Amplitude

The amplitude is the difference between the highest and the lowest measured value of the AC signal (the actual data). The displayed result is measured by taking samples from all the bits in a telegram. Not the entire bit is measured, but only a small part to filter out irregularities such as overshoots.

12.2.4.2 Jitter

Jitter is described as 'Zero-crossing point deviation', which means that the changing of a bit does not occur at the intended time. This is acceptable within the limit of 3200 nanoseconds, positive or negative. Causes for high jitter times can be wiring mistakes, EMI, cable cross talk or device problems.

12.2.4.3 Polarity

This is NOT the polarity of the bus wiring, but the internal communication signal. In some products it is possible that the polarity is switched. This does not affect the communication.

12.2.4.4 DC noise

The DC noise indicates how much the voltage of the signal varies. If the noise is too high it can influence the communication; it should not exceed 100 mV.

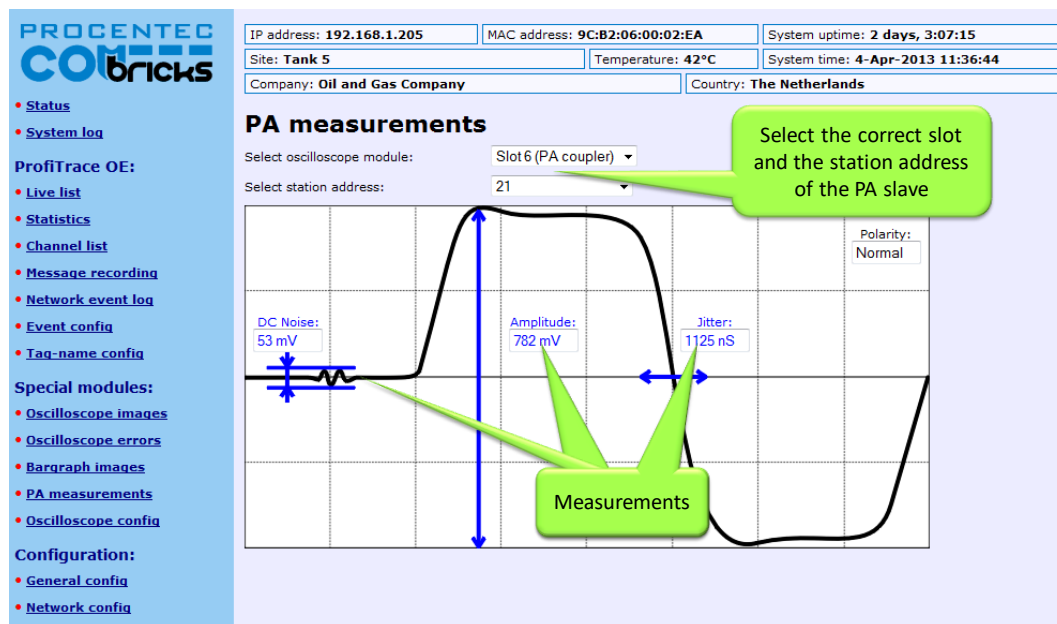

Fig. 87 - PA measurements

12.2.5 Oscilloscope configuration

In the Oscilloscope Config page (see **Fig. 88**) you can set various warning levels for the PA module. These warning levels are shown in the PA Bar Graph, and are used for e-mail alarms, logging and output control (see paragraphs 0 and 5.4).

The screenshot displays the 'Oscilloscope configuration' page. At the top, system information includes IP address (192.168.1.216), MAC address (9C:B2:06:00:02:8C), and system uptime (0 days, 4:18:18). The left sidebar contains a navigation menu with categories like 'Status', 'System log', 'ProfiTrace OE', 'Special modules', and 'Configuration'. The main content area is titled 'Oscilloscope configuration' and is divided into several sections:

- General oscilloscope settings:** Includes 'Maximum number of images per page' (set to 9), 'Line color' (set to Purple), and 'Error images buffer type' (set to Ring buffer).
- 1 Channel RS485 SCOPE Repeater Type 1:** Includes 'Termination min level (mV):' (700), 'Termination max level (mV):' (1300), and 'Bargraph OK limit (mV):' (2500).
- Other SCOPE Repeater settings (these settings can be saved in the modules themselves):** A table with columns for Slot, Module, Variable, Current value, Lower limit, and Upper limit.

Slot	Module	Variable	Current value	Lower limit	Upper limit
1	1 Channel RS485 SCOPE Repeater Type 1	Idle level	1111 mV	Use above table	Use above table
		Bargraph level	7925 mV	Use above table	Use above table
		Bargraph level	min: 737 mV max: 774 mV	200	1000
		Jitter level	1000 nS		3200
2	1 Channel PA-coupler 500mA Type 1	DC voltage	23955 mV	9000	32000
		DC noise	45 mV		100
		DC current	5 mA		475

A yellow arrow points to the 'Oscilloscope config' menu item in the sidebar. A green callout box labeled 'Module specific settings' points to the 'Bargraph level' row in the table for Slot 2.

Fig. 88 - Oscilloscope configuration

12.3 Link mode (module firmware v2.10.1 and higher only)

To use the module in Link mode, make sure it has module firmware version 2.10.1 and up, and NOT version 1.x. Refer to **paragraph 17.2** for updating your PA module. Also update the Head Station firmware to 1.279 or higher.

Set the 3rd dipswitch 'LNK' to 'ON' (to the right). Then connect a power source to the connector on top of the module. The DC voltage offered to the PA coupler module is the same as the output on the PA side. The minimum is 11VDC, maximum is 28VDC.



This module is now a fully functional PROFIBUS PA Link/Coupler combination. It is semi-transparent on all baud rates, it also sends FDL status requests onto PA. It supports connection of up to 126 devices that can take up a total of 500mA from the bus. Furthermore, all functionality described in paragraph 12.2 is also available in Link mode.



To receive telegrams from a PLC or DCS in Link mode, you need to install another module in the ComBricks backplane. This module can be any PROFIBUS DP interface card, either fiber optic or copper. All modules in chapters 7, 8 and 9 can be used. Set this DP card to the same network as the PA module.

12.3.1 Converting PA GSD files

For PA devices to correctly work in a DP configuration environment, it is necessary to alter the GSDs. It is highly recommended to use our GSDConvert tool for this, and NOT do it manually! The tool changes several lines in the GSD file so that it can be used on all baud rates instead of only the PA baud rate.

Download the tool on www.procentec.com.

Simply choose a GSD file and click 'Open', then choose the location to save it and click 'Save'. The program will create a new GSD file with 'LNK_' as the first four characters. The last four characters are the Ident number of the slave.

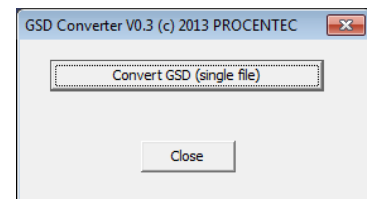

Import the new file into the configuration tool and use it as if it was a normal DP slave. Any baudrate can be used on the DP-side.

In Link/Coupler mode, the module has a fixed master address 1 on the PA side. The use of address 1 for PA field devices is therefore not possible.

12.3.2 Link configuration – bus parameters

The PA module in Link mode offers the possibility to configure the Watchdog time and the number of retries on the PA bus. These bus parameters are independent from the DP master parameters. Click on the Status page and then on the PA module to configure these parameters. See **Fig. 89** for available options.

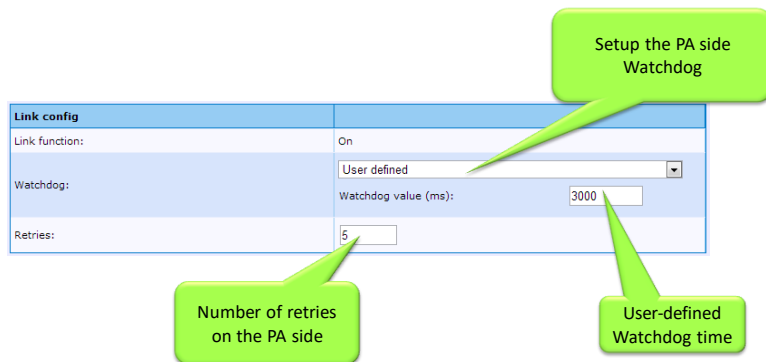

Fig. 89 - Configuration of bus parameters on PA

Options for the Watchdog selection:

- Off (not recommended)
- No change (PA watchdog is the same as DP watchdog)
- Scaled (Watchdog is calculated based on DP watchdog)
- User-defined (enter the watchdog time manually).

The number of retries can also be adjusted. This must be a number between 0 and 15.

12.3.3 Cycle time calculations

The cycle time on the PA bus can be calculated roughly with this formula and variables:

PA link delay time = 14.5 ms

N = number of PA instruments

InsBytes = number of bytes per PA instrument

$$\text{Cycle Time on PA} = N * (0.256 * \text{InsBytes} + 14.5) + 40$$

Example: two PA instruments, each with 10 bytes

$$(2 * (0.256 * 10 + 14.5)) + 40 = 74.12 \text{ ms}$$

12.4 Coupler mode

Make sure to set the 3rd dipswitch 'LNK' to 'OFF' (to the left). Then connect a power source to the connector on top of the module. The DC voltage offered to the PA coupler module is the same as the output on the PA side. The minimum is 11VDC, maximum is 28VDC.



This module is now a fully functional PROFIBUS PA coupler. It is totally transparent up to 1.5 Mbit/s, it also sends FDL status requests onto PA. It supports connection of up to 32 devices that can take up a total of 500mA from the bus. Furthermore, all functionality described in paragraph 12.2 is also available in Coupler mode.



To receive telegrams from a PLC or DCS in Coupler mode, you need to install another module in the ComBricks backplane. This module can be any PROFIBUS DP interface card, either fiber optic or copper. All modules in chapters 7, 8 and 9 can be used. Set this DP card to the same network as the PA Coupler module.

12.4.1 Bus Parameters

Some adjustments to the bus parameters in the PLC or DCS need to be made. Follow **Table 8** for your master project:

Table 8 - Bus Parameters for PA projects, in bit times

Baud rate	Tslot (only DX)	MaxTSDR (only DX)	Tslot (with DP-V1)	MaxTSDR (with DP-V1)
9.6 – 19.2 kbps	330	145	1500	150
45.45 kbps	640	480	640	480
93.75 kbps	2500	1000	2500	1000
187.5 kbps	3200	1500	14000	1400
500 kbps	8500	4000	38000	3700
1.5 Mbps	25500	11500	110000	11000

These are ‘worst case’ values. It is recommended to examine the timing of your installation and decrease the bus parameters to a suitable value for your network.

The DP-V1 table has higher slot times than the Data Exchange table because DP-V1 telegrams can be up to 240 bytes. Such a telegram takes a long time to be generated, and therefore the Tslot needs to be larger.

In small applications it is required to set a value for the Tset parameter. Usually a value of 95 is sufficient.

Because of the longer Slot Time and MaxTSDR, it is also recommended to set the Watchdog to at least 2 seconds. This is normal in PA networks.

In Coupler mode, the module has no bus address on either side. When configuring your PA network there is no restriction in the use of addresses for field devices, although most configuration tools do not allow address 0, 1 and 2.

12.5 Physical layer

12.5.1 Connecting a PA segment

The bottom of the PA module has two identical connections for the PA trunk. These are connected 1-on-1. As stated above the integrated termination is ON when power is connected to the PA module, which means that the PA module is always the start of a segment. The automatic termination cannot be disabled. Most installations will use only one connector. In that case it does not matter which connector is chosen. See **Fig. 90** for an example.

It is also possible to use the second connector as a stub line, as shown in **Fig. 91**. Do not terminate the end of a stub line, otherwise the PA segment has too many terminations.

Examples:

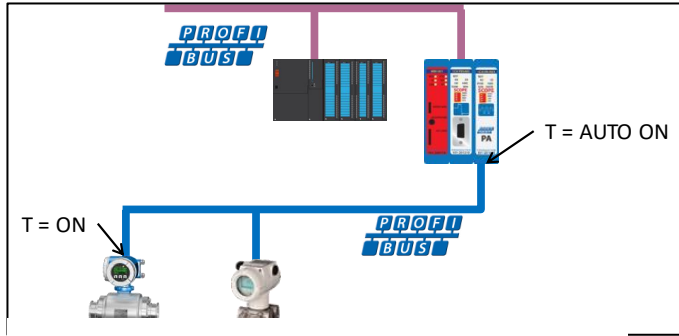

Fig. 90 – PA segment using one connector

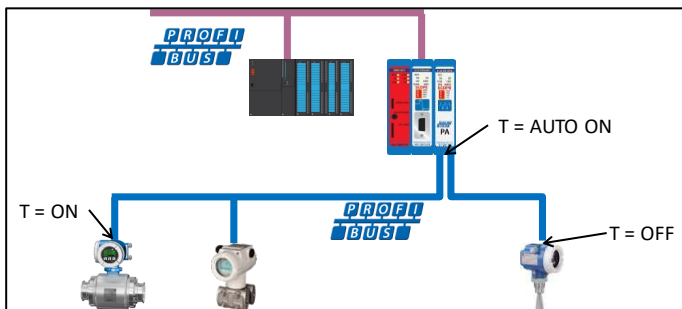

Fig. 91 - PA segment with a stub line

12.5.2 Cable specifications

Use the correct cable for your project.

Table 9 shows the cable specifications for PROFIBUS PA. If a cable is not compliant with these specifications, the reliability of the installation may become unstable.

Table 9 - Cable specifications

Characteristic	Specification
Cable design	Twisted pair, shielded
Maximum conductor cross section (nominal)	0.8 mm ² (AWG 18)
Loop resistance (direct current)	44 Ohm/km
Impedance (31,25 kHz)	100 Ohm ±20%
Attenuation (39 kHz)	3 dB/km
Capacitive asymmetry	2 nF/km
Max. propagation delay change (7.9 to 39 kHz)	1.7 µsec/km
Max. shield coverage	90%
Cable length	1900 m

12.5.3 Spur lines

The trunk line on the PA module can have up to 32 spur lines with the following lengths:

Table 10 - Spur lines

Number of spur lines	Length of the spur (Non-Ex)
25 to 32	Max 1 meter
19 to 24	30 meter
15 to 18	60 meter
13 to 14	90 meter
1 to 12	120 meter

The PROFIBUS PA specification allows up to 3 devices on a spur. Please refer to paragraph 12.5.1 for an explanation on how to connect the PA trunk to the PA module.

12.5.4 Current consumption calculations

The PA module provides a maximum of 500mA to the PA trunk. The total current consumption of all slaves on this trunk cannot exceed 500mA. The PA module consumes 10mA. At least one FDE (Fault Disconnection Electronics, stated in the manual of the PA device) should also be calculated. The calculation for the current consumption is as follows:

$$I_{SEG} = I_{B0} + I_{B1} + \dots + I_{BN} + I_{FDE}$$

I_{SEG} = Total current in a segment

I_{BN} = Basic current of devices

I_{FDE} = Current of the Fault Disconnection Electronics

See **Fig. 92** for an example.

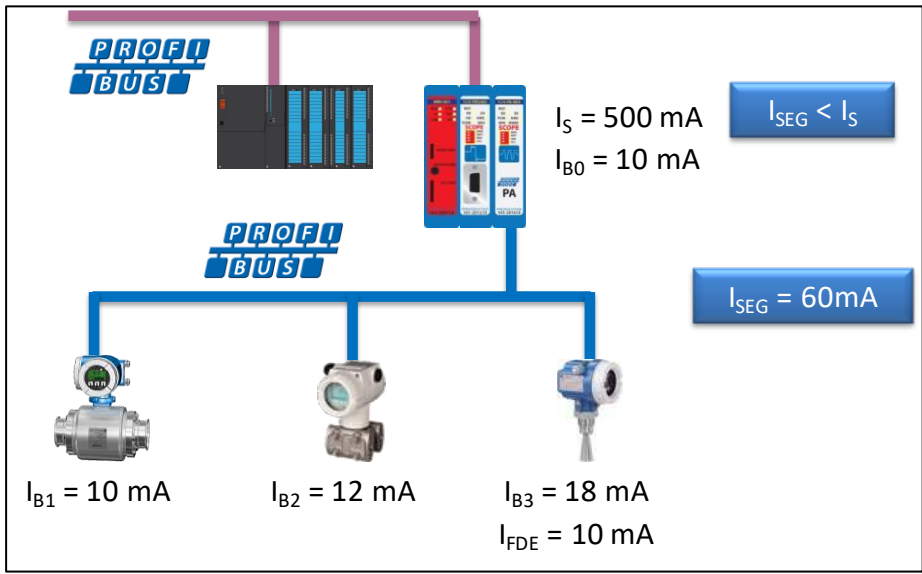

Fig. 92 - Example of current consumption calculation in a PA segment

12.5.5 Voltage at the end of the segment

The resistance of the cable causes a lower voltage at the end of the cable. At least 9V should be available for the last device at the end of the cable. The following calculation is a 'worst case' scenario where all devices are connected at the end of the cable:

$$U_B = U_S - (I_{SEG} * R_{CABLE} * L_{SEG}) \quad (\text{where } U_B > U_{min})$$

- U_B = Bus voltage at the last device (V)
- U_S = Voltage of the segment coupler (V)
- I_{SEG} = Total current in a segment (A)
- R_{CABLE} = Resistance per unit length of the cable (Ω/km)
- L_{SEG} = Length of all cables in the segment, including stubs (km)
- U_{min} = Minimal specified operating voltage of the last device (V)

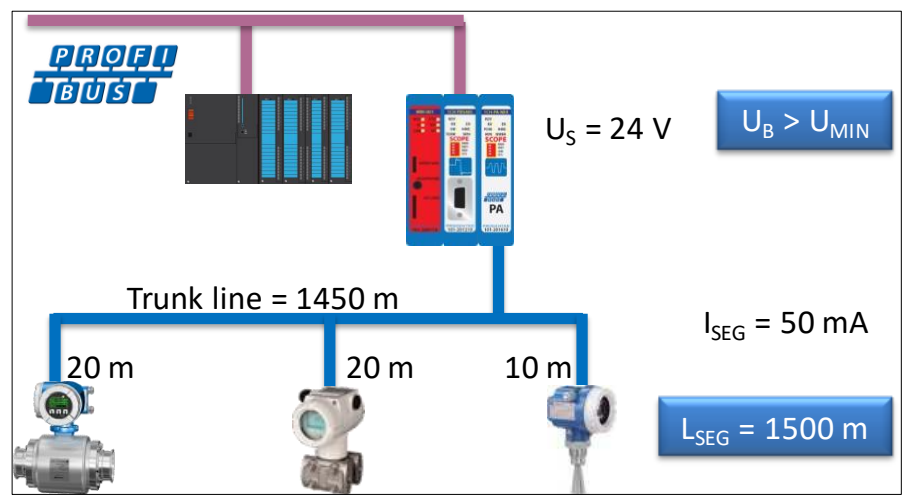

Fig. 93 - Example of voltage calculation at the end of the cable

In this example the voltage at the end of the cable is $24 \text{ V} - (0.05 \text{ A} * 44 * 1.5) = 20.7 \text{ V}$

13 PROFINET Device PND-001

The ComBricks PROFINET Device enables multiple proxies between other inserted PROFINET modules. Simultaneously the user can let the PROFINET Device publish I/O modules which are controlled by the PLC that has the PROFINET Device in Data Exchange.

It's the component of choice to establish communication between multiple PROFINET controllers that manage their own specific network. The proxy works the same way as regular DP/DP and PN/DP couplers. Configurations from the GSD file define the data area between the modules. ComBricks has the advantage that 10 PROFINET modules can cross exchange information.

When the PROFINET Device has to publish I/O modules, the configuration steps are the same as any PROFINET device. By means of the GSD file the respective I/O modules have to be selected in the configuration tool, after which the PLC can map the I/Os to its application.

Application areas

- Coupling small machines
- Linking networks with different controllers
- Coupling PROFI-safe networks to regular networks
- Migrating from old control systems to new control systems
- Quasi master-master communication



13.1 Topologies

The PROFINET modules can be used as a proxy between one or multiple PROFIBUS or PROFINET networks, and/or can be configured as PROFINET devices which control one or more output modules.

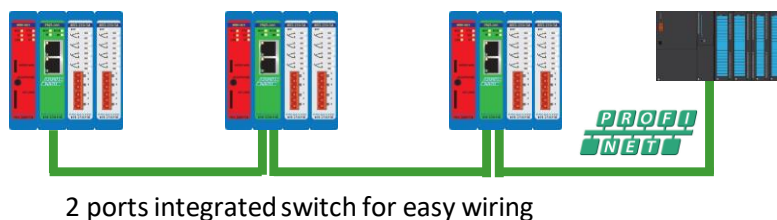
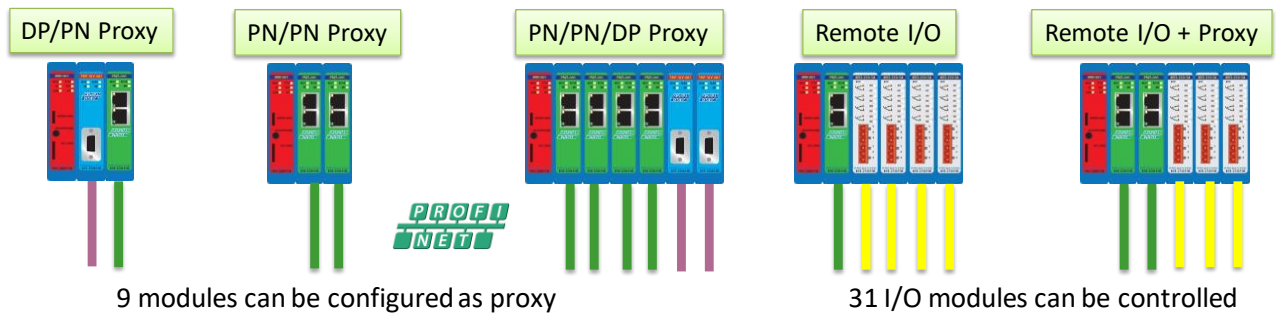

13.2 Status LEDs

The PND-001 module has four diagnostic LEDs. These LEDs indicate whether the module is functioning properly.

13.2.1 RDY LED

The RDY LED indicates power supply and connection with the Head Station. Also a firmware update is indicated with this LED.

LED	State	Meaning
RDY (green)	Off	No power supply, or PND-001 module is faulty. There is no voltage at the module, or the module has a hardware defect. Remedy: Connect the 24 V DC supply voltage at the Head station.
	Flashing (1 Hz)	The PND-001 module is connecting with the Head Station. This state is allowed for a short time (max 1 minute).
	Flashing (0.3Hz)	A backplane firmware update of the PND-001 module is executed by the Head Station (max 1 minute).
	On	The connection with the Head Station is established.

13.2.2 PROFINET LEDs

The PND-001 module has three PROFINET diagnostic LEDs: RUN, SF (System Fail) and BF (Bus Fail).

LED	State	Meaning
RUN <i>(green)</i>	Off	Internal application firmware is not running (PROFINET stack). Remedy: Update application firmware.
	On	Internal application firmware is running (PROFINET stack).
SF <i>System Fail (red)</i>	Off	No error
	On	System error, or the received expected configuration (from configuration tool) does not match the actual configuration (I/O or proxy modules in the backplane).
	On	PND-001 module is not in Data Exchange with a PROFINET master.
BF <i>Bus Fail (red)</i>	Off	PND-001 module is in Data Exchange with a PROFINET controller.
	Flashing (0.5 Hz)	No data transfer between the PROFINET Controller and the PND-001 module, although a physical link is established Causes: <ul style="list-style-type: none"> • Incorrect device name • The PROFINET Controller is switched off Remedy: <ul style="list-style-type: none"> • Check the configuration and assign a valid device name to the PND-001 module. • Check the PROFINET Controller.
	On	No physical link. Remedy: check the cable and switch.

13.3 Quick Start checklist

This checklist lists all the steps to a quick usage of the PROFINET Device module as a Remote I/O station.

- | | | |
|-----------------|--|---------------|
| STEP 1: | Provide the Head Station 1B or 1C with the latest firmware, at least v1.272. | (7) |
| STEP 2: | Add at least two empty backplane slots to the ComBricks set. | (2.2) |
| STEP 3: | Use the rotary switch on the bottom to assign a custom or pre-defined name to the PROFINET device. | (13.4) |
| STEP 5: | Insert the PROFINET Device module in one empty slot. Do not insert it in slot number 11 or higher; this is not supported by the ComBricks. | (2.3) |
| STEP 6: | Insert a DI/DO/Relay card in the other empty slot. | (2.3) |
| STEP 7: | Provide power to the Head Station. | (4.2) |
| STEP 8: | Connect the Head Station to the Ethernet network with an Ethernet cable. | (4.2) |
| STEP 9: | Connect a PROFINET cable and connector to one of the RJ45 connectors. | |
| STEP 10: | Check the Channel List (in web browser) to see if the modules appear. | (4.2) |

13.4 Identification and name assignment

13.4.1 MAC address

Each PROFINET-enabled network component has its own unique MAC-address. The MAC-address of the PND-001 is located on a label on the upper side of the module and has the following format:

9C:B2:06:xx:xx:xx

13.4.2 Assigning a custom name

The PND-001 supports fixed name assignment and custom name assignment. On the bottom of the module is a rotary switch. In position '0' the module is programmable with a custom device name, and the name is stored in non-volatile memory. With the rotary switch set to '0' during startup, the name will be read from memory.

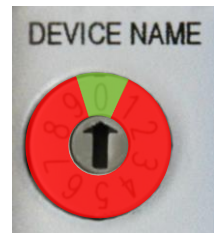

The device name can be assigned with configuration tools or supervisor tools such as Step-7 or Netilities, as shown in **Fig. 94** and **Fig. 95**.

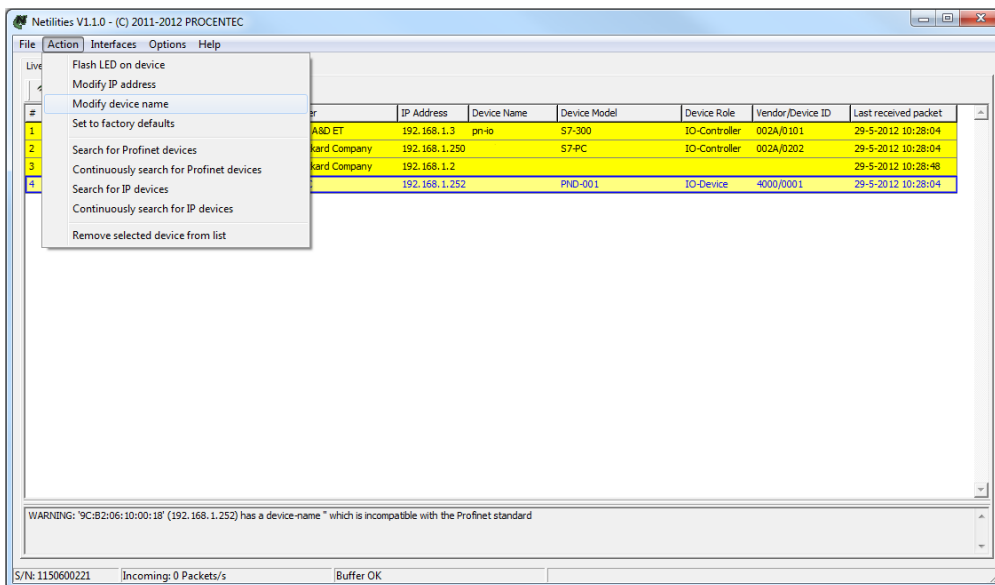

Fig. 94 - Assigning a new device name

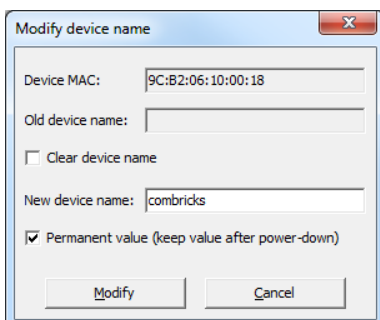

Fig. 95 - New device name options

The checkbox 'Permanent value' should be enabled if you wish to save the name to non-volatile memory.

13.4.3 Assigning a pre-defined name

The positions 1 - 9 of the rotary switch assign a pre-defined name to the device. The name has the format “ComBricks-x” where ‘x’ corresponds to the selected digit of the rotary switch.

For example, in position 4 the module has the following device name: “ComBricks-4”. The name is read during startup of the module; changing the rotary switch during operation does not change the device name.



13.5 Remote I/O mode

The PND-001 module can be included in a PLC project with the GSDML as any other PROFINET device. After the module has been set up with a name, you can start configuring it in the network with the configuration tool of the PLC. Refer to the manual of the supplier of your configuration tool for instructions for that tool.

This example, a typical ComBricks setup with remote I/O, is built up as follows (see Fig. 96).

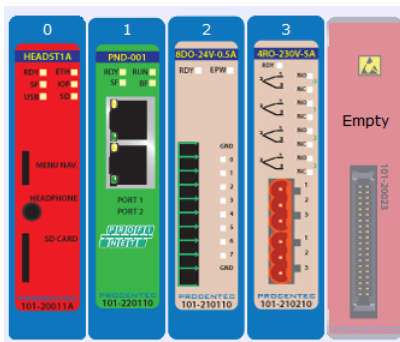

Fig. 96 - Example configuration for Remote I/O

The first slot is occupied by the PND-001 module, and next to it are an 8DO and Relay module.

Open the PROFINET Controller configuration tool and insert/import the PND-001 GSD with filename “GSDML-V2.25-PROCENTEC-ComBricks PND_001-20120831.xml” (download it from www.procentec.com/gsd).

Then insert the correct modules into the configuration tool. Drag the following device into the configuration: ‘Head Station+PND-001(SLOT 01)’. Make sure that this slot corresponds with the physical slot of the PND-001. See Fig. 97.

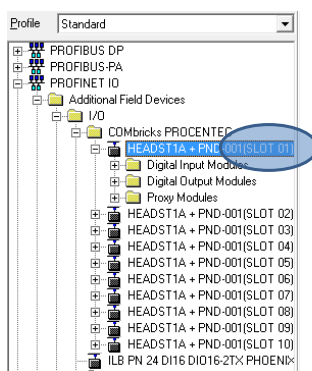

Fig. 97 - Select the device with correct slot number

Next, insert the correct modules into the configuration tool. In the 2nd slot place a 8DO-24V-0.5A, and the last module is the 4RO-230V-5A.

Fig. 98 shows the complete configuration for this ComBricks system.

Slot	Module	Order number	I address	Q address	Diagnostic address:
0	COMbricks	101-20011A			2045*
X1	PN-I/O				2040**
1	PND-001	101-220110			2039**
X1 A	Port 1				2038**
X1 A	Port 2				2037**
2	8DO-24V-0.5A	101-210110	5	7	
3	4RO-230V-5A	101-210210		8	
4					

Fig. 98 - Configuration of the modules

13.6 PN/PN coupling or Proxy mode

A unique feature of the PND-001 module is that it can be used as a PN/PN coupler for up to 10 networks. It connects the networks on an I/O level, where you can decide how many bytes need to be transferred. For each network a PND-001 is needed. So if you wish to connect 2 networks, you need 2 PND-001 modules in one ComBricks set.

A typical ComBricks configuration for a PN/PN setup may look like this:

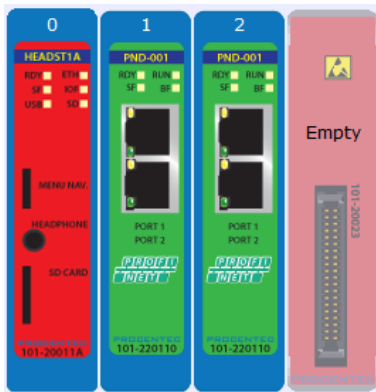
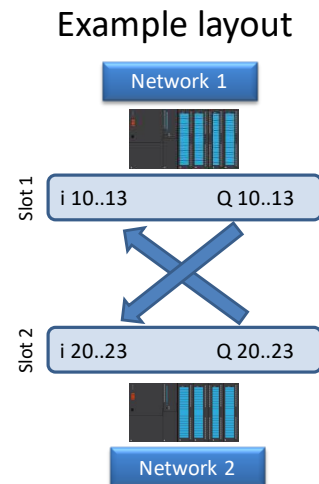

Fig. 99 - ComBricks configuration screenshot of the web server



Slot 1 belongs to Network 1. Slot 2 is connected to Network 2. These networks can now be coupled via the configuration tools of each master. For example, if you want to transfer 1 byte, the setup for the configuration tool of network 1 will look as follows:

Slot	Module	Order number	I address	Q address
0	COMbricks	101-20011A		
X1	PN-I/O			
1	PND-001	101-220110		
X1 A	Port 1			
X1 A	Port 2			
2	001 Byte IN/OUT PROXY	101-22XXXX	1	1
3				

Fig. 100 - Schematic representation of the proxy

The first slot is used for the PND-001 module. The next slot is used for another PND-001 module, but a proxy module must be selected because the PND-001 itself does not have any I/O. The setup for the second network will look as follows:

Slot	Module	Order number	I address	Q address
0	COMbricks-1	101-20011A		
X1	PN-IQ			
1	001 Byte IN/OUT PROXY	101-22XXXX	2	2
2	PND-001	101-220110		
X1	Part 1			
X1	Part 2			
3				

Now the Inputs and Outputs of both networks can be sent to the I/O of the proxies in the PLC program.

13.7 PROFINET / PROFIBUS proxy

The PND-001 module can also be used as a proxy to a PROFIBUS module. This works in the same way as the PN/PN coupler. Simply replace the second PN module for a PROFIBUS PBS-001 module. Or extend the PN/PN coupler with a PROFIBUS module, as shown below. With this example you can exchange I/O from and to all networks. It is also possible to exchange data between more than 3 networks; up to 10 networks can be connected. It does not matter if these networks are PROFIBUS or PROFINET.

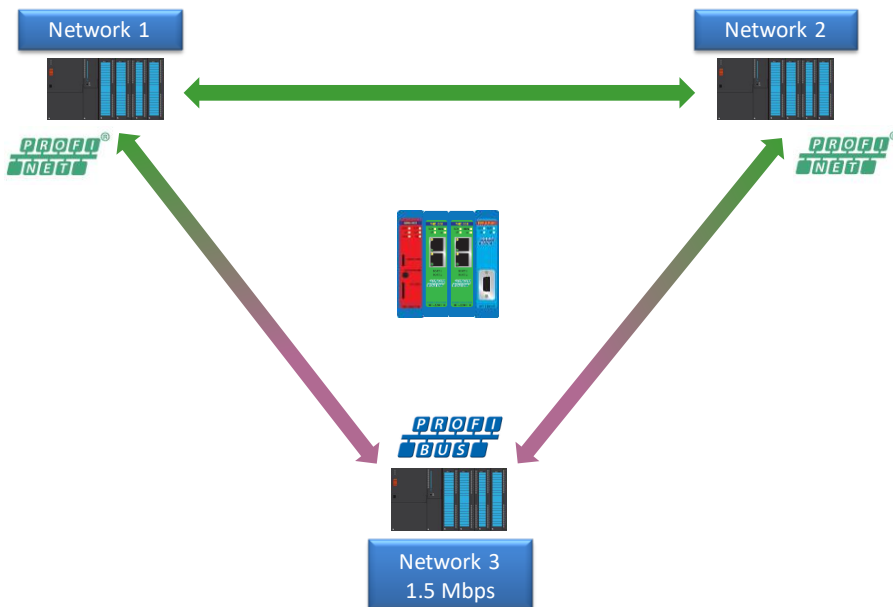

Fig. 101 - Example network layout of two PROFINET and one PROFIBUS networks

The configuration of the networks is as follows:

Slot	Module	Order number	I address	Q address
0	COMbricks	101-20011A		
X1	PN-IQ			
1	PND-001	101-220110		
X1	Part 1			
X1	Part 2			
2	001 Byte IN/OUT PROXY	101-22XXXX	1	1
3	001 Byte IN/OUT PROXY	101-22XXXX	2	2
4				

Fig. 102 - Configuration for PROFINET network 1

Slot	Module	Order number	I address	Q address
0	COMbricks-1	101-20011A		
X1	PN-IQ			
1	001 Byte IN/OUT PROXY	101-22XXXX	3	3
2	PND-001	101-220110		
X1	Part 1			
X1	Part 2			
3	001 Byte IN/OUT PROXY	101-22XXXX	4	4
4				

Fig. 103 - Configuration for PROFINET network 2

Slot	DP ID	...	Order Number / Designation	I Address	Q Address
1	194		001 byte IN/OUT PROXY	5	5
2	194		001 byte IN/OUT PROXY	6	6
3	2		PBS-001		
4					

Fig. 104 - Configuration for the PROFIBUS network

Now the inputs and Outputs of all networks can be sent to the I/O of the proxies in the PLC programs.

14 CommDTM

The ComBricks Head Station features a fully functional gateway between any Windows platform and field devices using a CommDTM. This enables the ComBricks to function as a real Asset Management tool. Currently we support FDT 1.2 frame applications such as PACTware and E+H FieldCare. During interaction with the CommDTM, all ComBricks functions can be used simultaneously (web based monitoring, oscilloscoping, OPC and alarms via email).

If you are using Siemens EDD files, you can convert these to DTM files using a tool called Sitrans DTM. More information can be found on www.siemens.com/sitransdtm.

Please note: It is not possible to use a Siemens DP/PA link to send DTM commands from DP to PA. Only the ComBricks PA module can send DTM commands on PA. To achieve this when using a Siemens Link, refer to paragraph 12.2 and setup the PA module in Monitoring mode.

14.1 Installing drivers, CommDTM and server

You can download the required PCD server and CommDTM installers separately from our website, located at the download section. You can also find the files in the Download page of the ComBricks itself. It is a ZIP file containing several executables, which should all be installed.

14.2 Setting up the PCD server

Start the PCD (PROCENTEC Communication Driver) server (located in /Program Files/PROCENTEC/PCD/). You should see the PCD logo in the system tray.



Right-click the PCD icon, then choose 'Show'. Click 'Modify', enter a name for the interface, choose the latest 'ComBricks PROFIBUS x.x' driver and click 'OK'. Note: You can leave the serial number field empty.

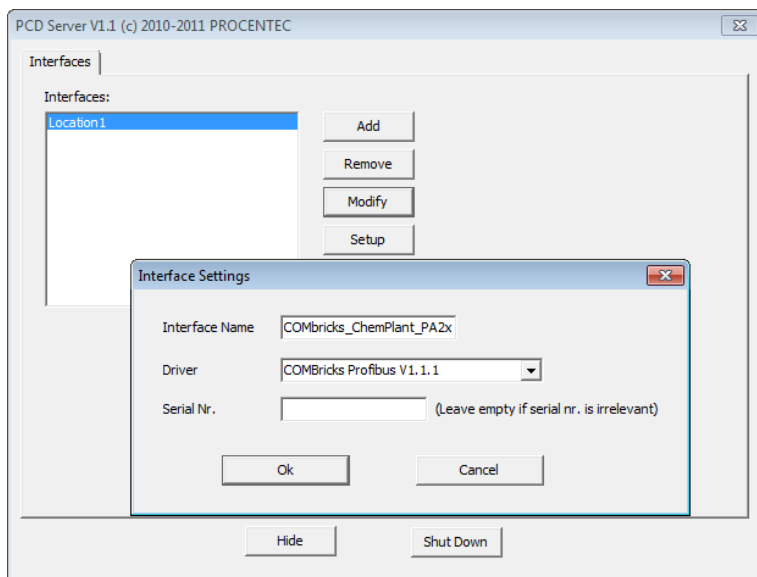
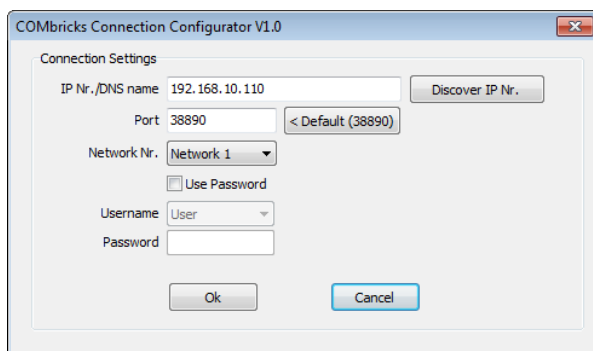

Fig. 105 - Setting up the PCD server



Next, select this location again and click 'Setup'. Enter the correct IP address of the ComBricks Head Station, and choose the port and network you wish to connect to. Depending on the password settings in the ComBricks, you might also have to fill in a username and password. Then click 'Ok'.

14.3 Using the CommDTM

Start your FDT manager and create or load a project. Vendor-independent platform PACTware is used in the example below. Refer to the manual of your FDT manager for details.

In the upper menu, choose 'Device – Add device' and click on 'PROCENTEC DP-V1 Master', as shown in **Fig. 106**.

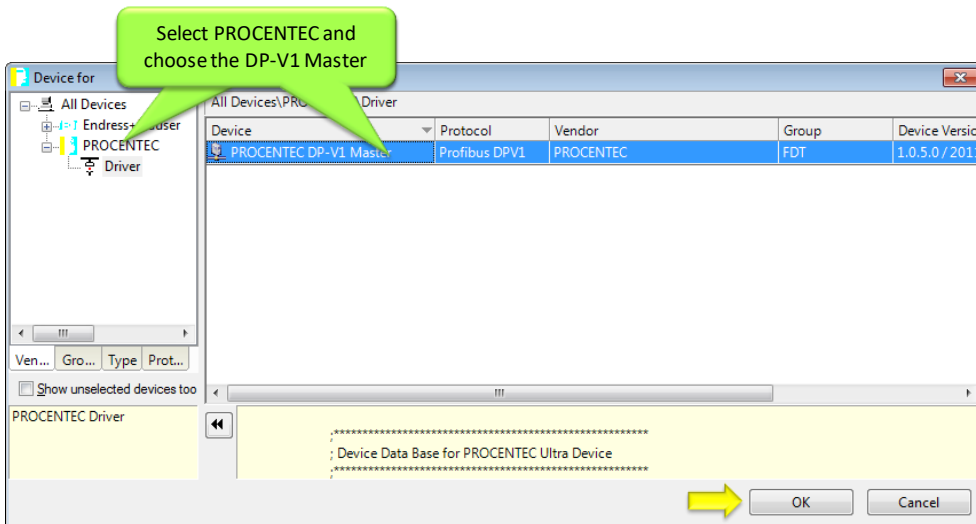
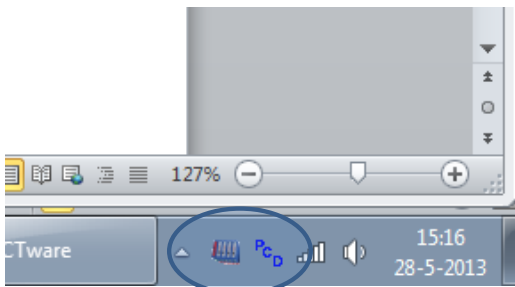

Fig. 106 - CommDTM selection dialog

After clicking 'OK' the PCD server is launched automatically (if it was not loaded already). You will see the ComBricks and PCD icons appear in the system tray:



In PACTware, make sure to set the correct bus parameters by right-clicking the PROCENTEC DP-V1 master and choose 'Parameters'. Enter the correct parameters or select 'Start' to auto-detect these (see Fig. 107). Then click 'OK'. Next, choose the icon 'Connect' from the top menu.

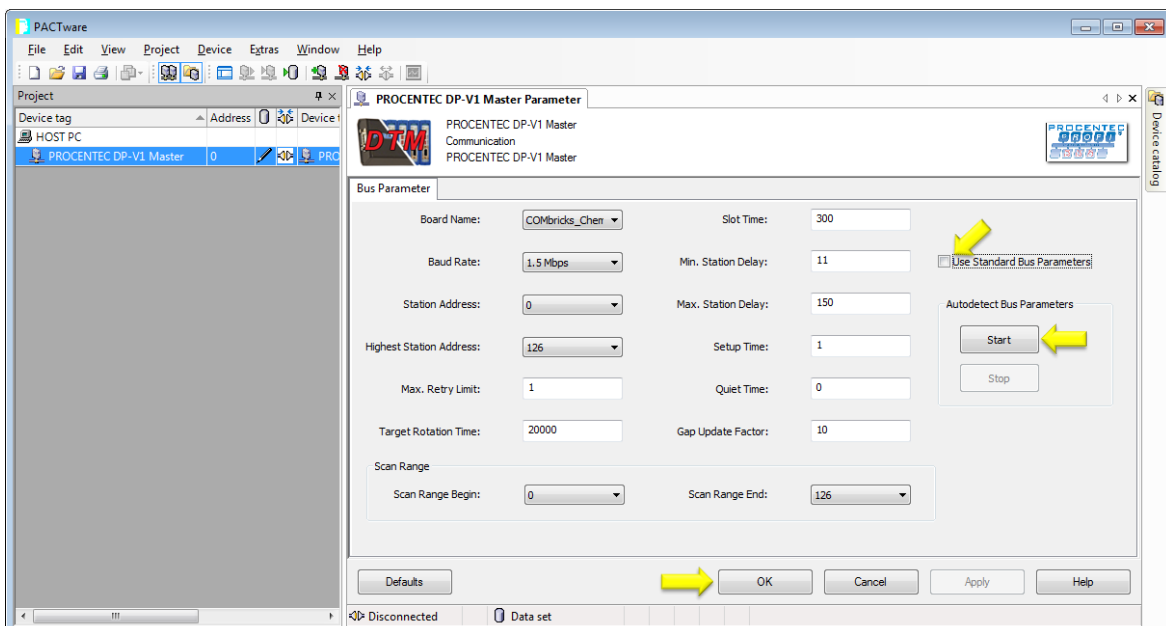

Fig. 107 - DTM master parameters

Please note: not all busparameters will be detected automatically; You can set them manually:

- Max. retry limit: recommended is a value of 3 or higher.
- Target Rotation Time: This is a calculated worst-case time for one token rotation on the PROFIBUS network. Look up this value in the primary master setup tool, and copy it here.
- Max Station delay: this value is defined by the slowest slave in the network. In most cases the default value is sufficient.
- Quiet time: only required in case of heavy reflections.

After you have correctly applied these steps, the ComBricks is now a DP-V1 master and ready for communication to field devices. For a detailed walk-through refer to the Download section of the PROCENTEC website for a comprehensive Quick Start for PACTware and FieldCare.

15 OPC

OPC functionality in ComBricks is available in the following way: By opening a stream from the ComBricks Headstation to a PC in the local network, all PROFIBUS messages are sent to this computer. This PC has ProfiTrace running, and in ProfiTrace the OPC server is active. So the actual OPC server is inside ProfiTrace, not in the Headstation. OPC tags can be added in the ProfiTrace OPC server, which can be read by OPC clients.

The ProfiTrace OPC Server offers a standardized interface to get the valuable ProfiTrace information such as device status, statistics and process variables into applications that carry an OPC client, such as SCADA, Excel, etc.

Many process or factory plants nowadays use SCADA or Asset management software to get an overview of the production status and application alarms. However, they have no insight on the PROFIBUS health and behaviour which could indicate a potential shutdown. This information contributes heavily to the installation uptime.

Using ProfiTrace OPC, it is possible to get the real live state of your PROFIBUS network directly in your SCADA system, allowing maintenance engineers and operators to react quickly to any PROFIBUS related alarms or irregular events coming up on the screen. The opportunities are vast and we are just discovering the possibilities what it could contribute to your asset management.

You can display ProfiTrace tags in a SCADA/HMI package or link it to an SMS/email client and send a message when something happens with the PROFIBUS installation or even generate your own report in MS Word/Excel. Every application that acts as OPC client can approach the ProfiTrace tags. It does NOT corrupt the PROFIBUS cycle time because the information comes from busmonitoring (listening).

15.1 Installing the OPC drivers

The PC that runs ProfiTrace has to be prepared for OPC by installing the drivers (see Fig. 108).

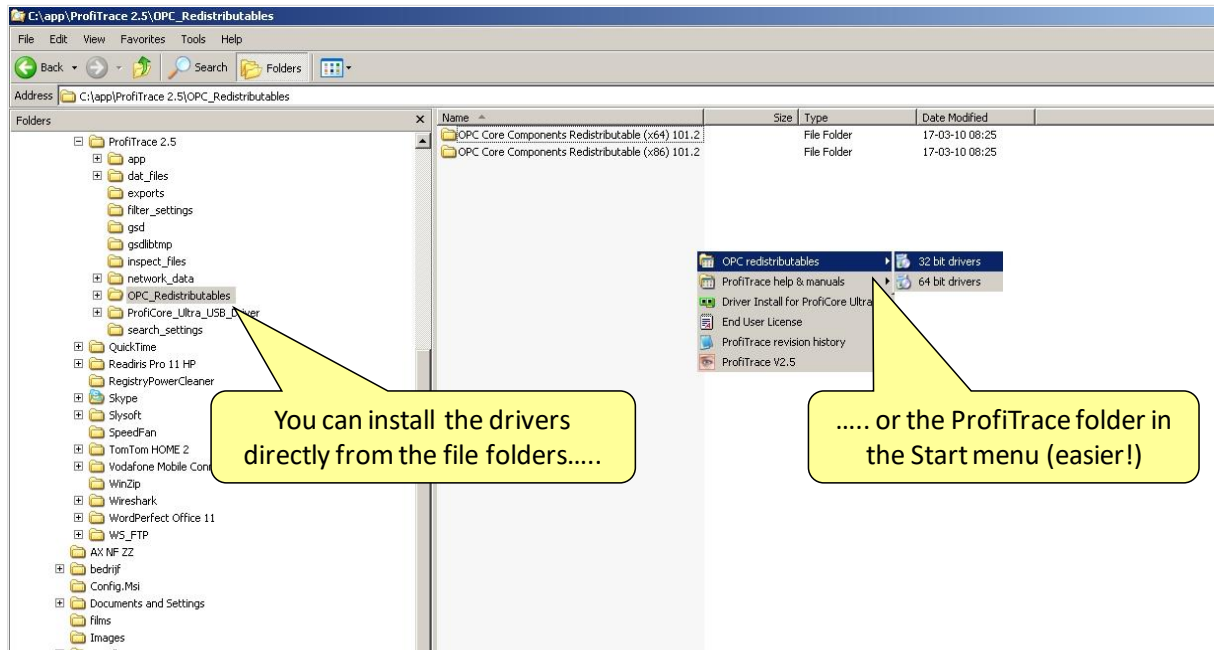

Fig. 108 - Location of the OPC drivers

15.2 Setting up a stream

To connect the ComBricks to ProfiTrace, see paragraph 5.9.

15.3 Selecting OPC tags

The OPC tag settings can be found in the Settings menu (see **Fig. 109**).

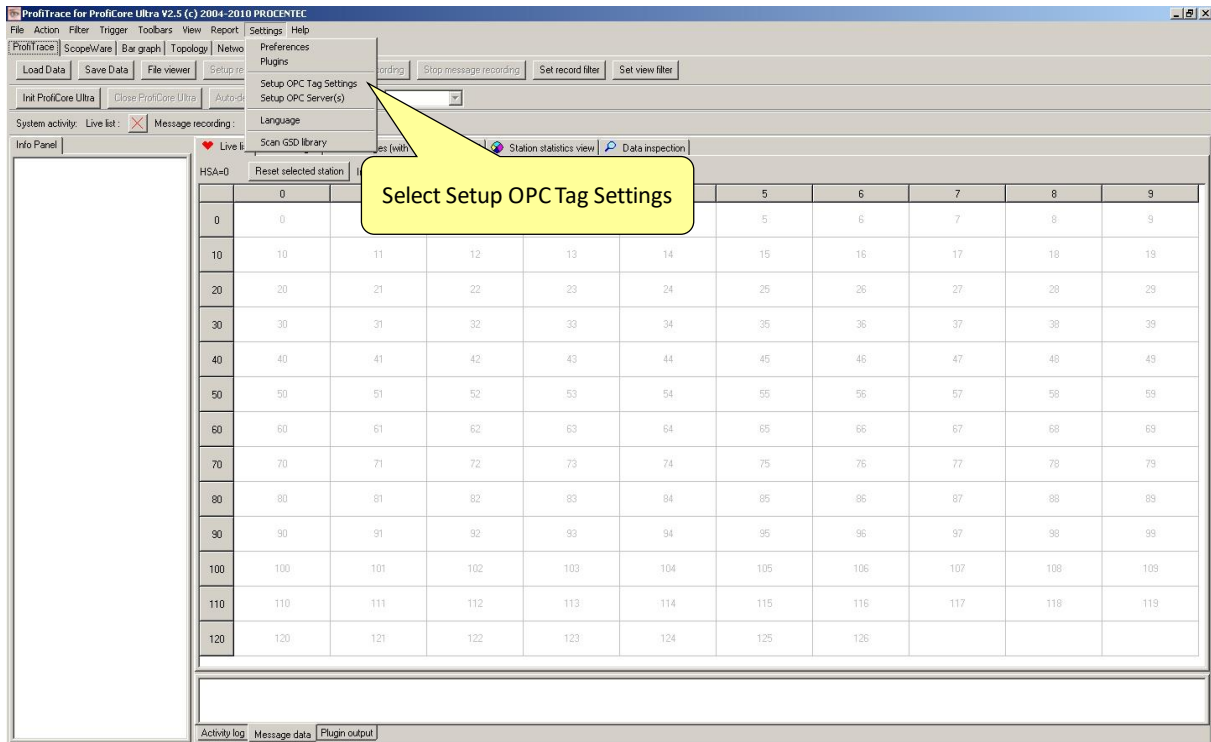

Fig. 109 - OPC tags in the Settings menu

In the next dialog you can add tags (see **Fig. 110**). All basic tags are already available (Live List, and Statistics). When you do not require additional tags, you do not have to enter this dialog and can you directly proceed to the server settings.

The OPC tags are locations in the I/O data of the devices (offset 0 is the first location).



Be careful with too many tags. The quantity of tags can slow down your system, especially when you want to run multiple applications at the same time. To solve this you can filter tags in the client you are using.

You can save your data in a .PTO file which is used later during the setup of the OPC server.

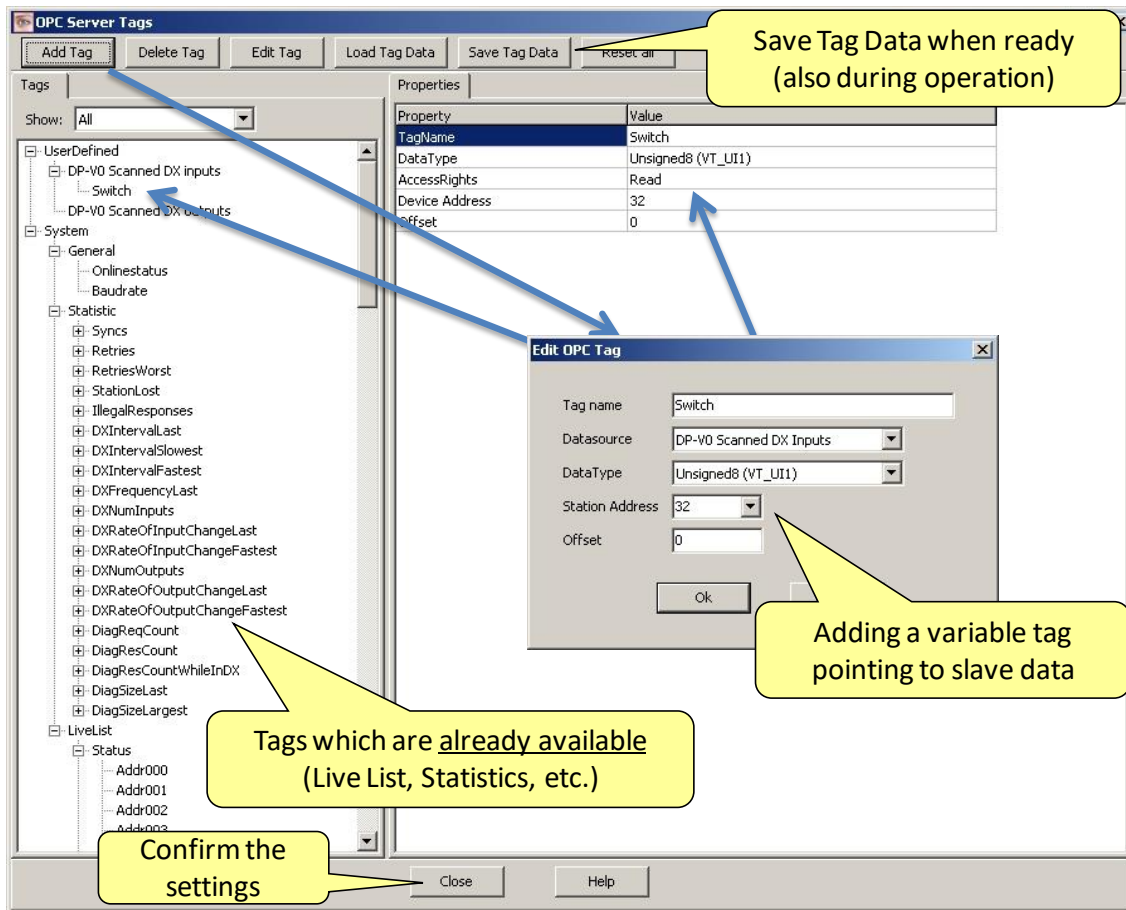

Fig. 110 - Adding OPC tags

15.4 Activating the OPC server

After setting up the OPC tags, the server has to be activated.

The OPC server settings can be found in the Settings menu (see **Fig. 111**).

In the next dialog the server can be added (see **Fig. 112**).



A maximum of 16 servers can be created, each with its own tag groups.

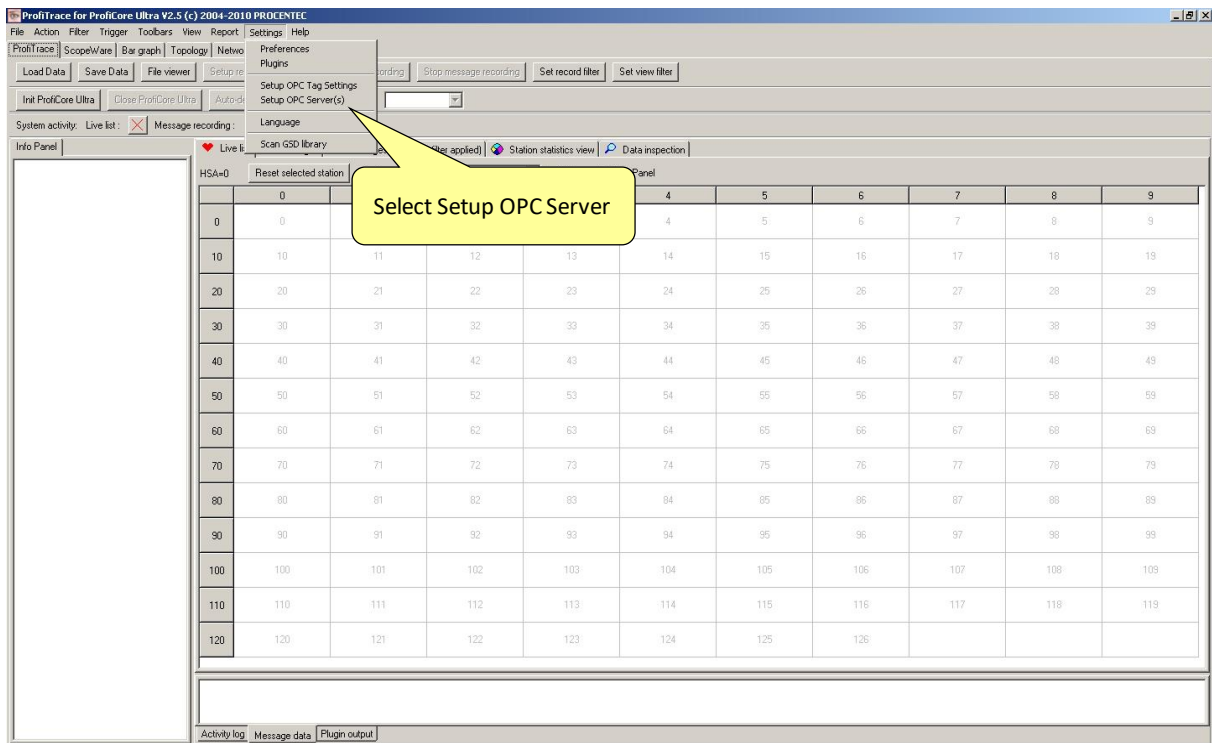

Fig. 111 - OPC server in the Settings menu

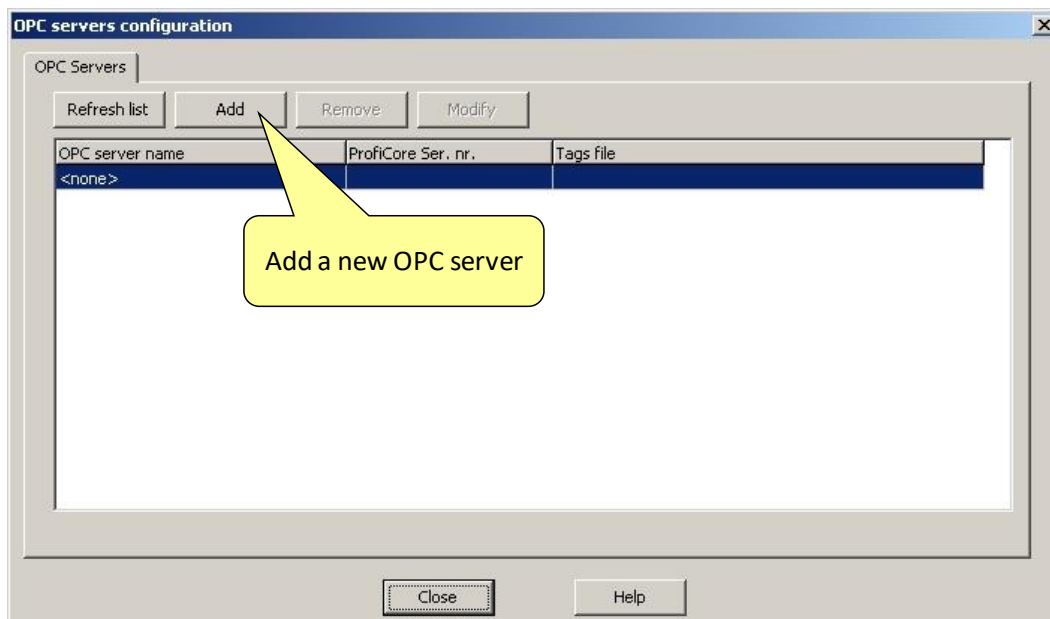

Fig. 112 - Adding the OPC server

Important: If you see an error message when adding/registering the server or tags, then restart the software and start ProfiTrace with 'Administrator rights by right-clicking the ProfiTrace executable and choosing 'Run as administrator'.

In the next dialog the properties of the server are set up (see Fig. 113).

Give it an appropriate name and indicate if you want to use the default tags or the .PTO file with the user defined tags. Also choose a ComBricks connection.

When the settings are completed click "close" and the OPC server will be active. In later stages the OPC server settings can be modified.

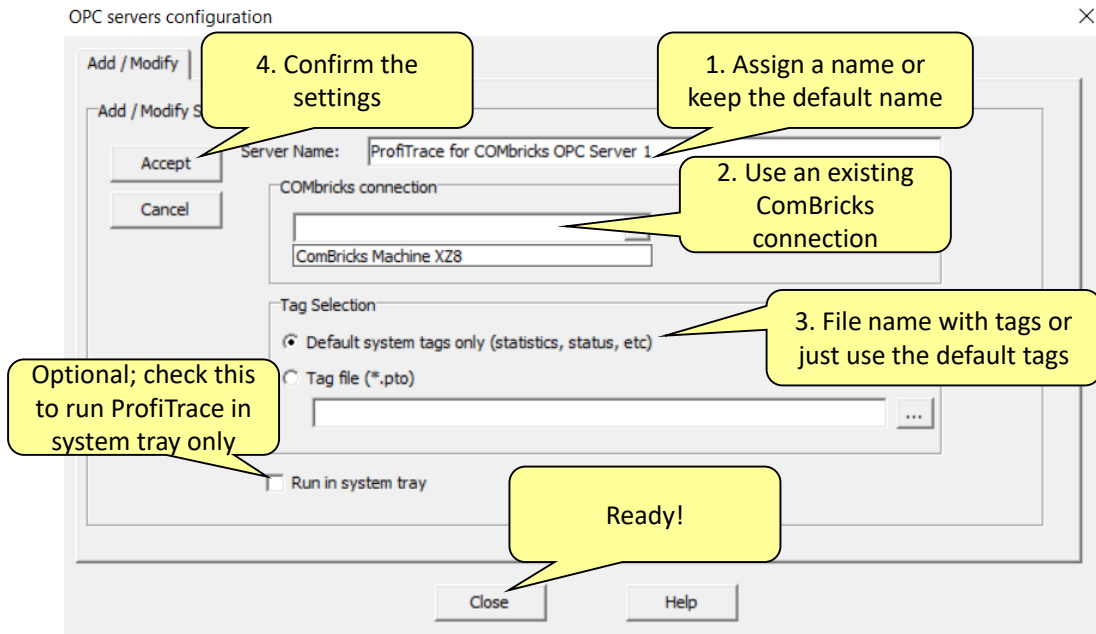

Fig. 113 - OPC server properties

From this point any application that has the availability of an OPC client can access the ProfiTrace OPC tags.

16 SNMP

The Headstation has a powerful feature, SNMP, available free of charge in every Headstation version. With SNMP you can retrieve any data via Ethernet that has been collected by the ComBricks system. This SNMP data can be used by network management tools or SCADA systems to visualize the collected data. This data ranges from Bargraph data (voltages) to statistics and Live List information. You can also retrieve the Headstation temperature or power consumption for example. This turns a SCADA system into a versatile monitoring or alarming station.

The SNMP MIB (Management Information Base) file, which is available for download on our website, contains the descriptions for all items. This MIB file should be used in a management tool or MIB viewer to retrieve the data from ComBricks.

16.1 List of data items

The following items can be retrieved with SNMPv1 and SNMPv2c from the ComBricks:

General items

- Serial number of the Headstation
- Firmware version of the Headstation
- Hardware version of the Headstation
- Backplane version
- FPGA version of the Headstation
- General description of the Headstation

Ethernet status

- MAC address
- IP address
- Subnet mask
- Default gateway
- DNS address
- DHCP state

Device

- System time
- System temperature
- System current
- System voltage
- System status
- System I/O status
- Micro SD card status
- License code
- Number of modules
- Module info

Data

- Livelist of all 4 networks
- Statistics of all 4 networks (Lost, Syncs, Repeats total, Repeats Max, illegals, Int diag, Ext diag, DX diag)
- Ident numbers of active devices, of all 4 networks
- Detected baudrate of all 4 networks
- Connected Ethernet clients
- Connected ports
- Physical measurements per slave:
 - Min
 - Max
 - Last
- Idle voltage per slave
- Bargraph settings

16.2 Viewing the MIB file

As an example the tool SNMPb will be used. This tool can be downloaded for free.

Prepare the SNMPb tool as follows:

1. Download and install SNMPb
2. Download the MIB file and place it in C:\Program files (x86)\Snmpb\mibs\
3. Start SNMPb and click the tab 'Modules'. Search for the module 'PROCEN-TEC-COMBRICKS-HS-T1-MIB', select it and click the button -> so that the module moves to the right table. It is now loaded.
4. Go back to the tab 'Tree' and click the setup button .



5. Enter a name for the profile and enter the IP address of the target ComBricks. Use default SNMP port 161 and other default settings. Then click OK.

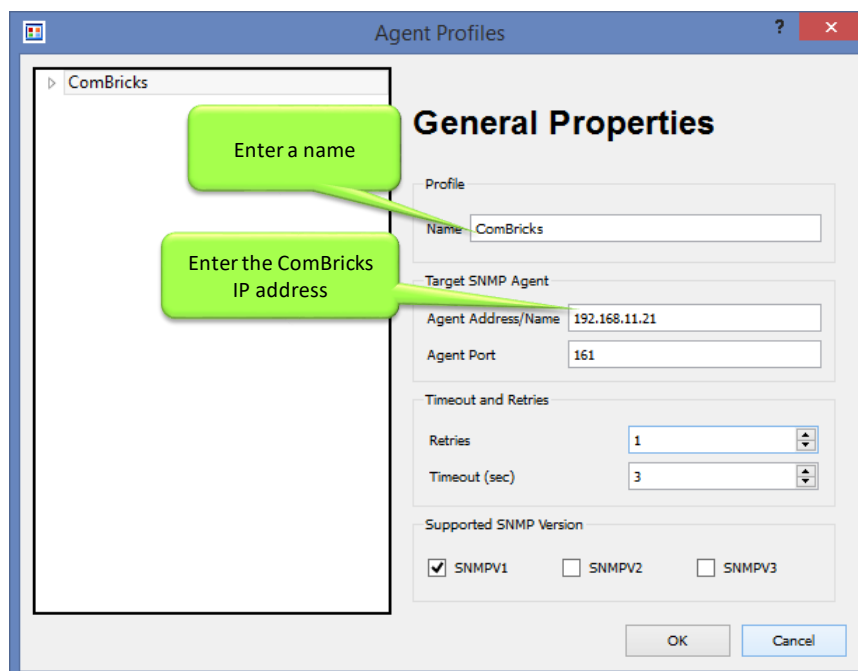

Now you can expand the items in the MIB tree by right-clicking on 'MIB Tree' and select 'Expand'. The first SNMP item you see is 'hsGenSerial' in the 'General' folder. To read this value, right-click and choose 'Get'. The program will now send an SNMP message to the ComBricks and the ComBricks will send the requested information back, which will now be visible in blue text.

You can also retrieve all information in the selected folder. Right-click a folder and choose 'Walk'. All information of items in the selected folder or entry will now be retrieved.

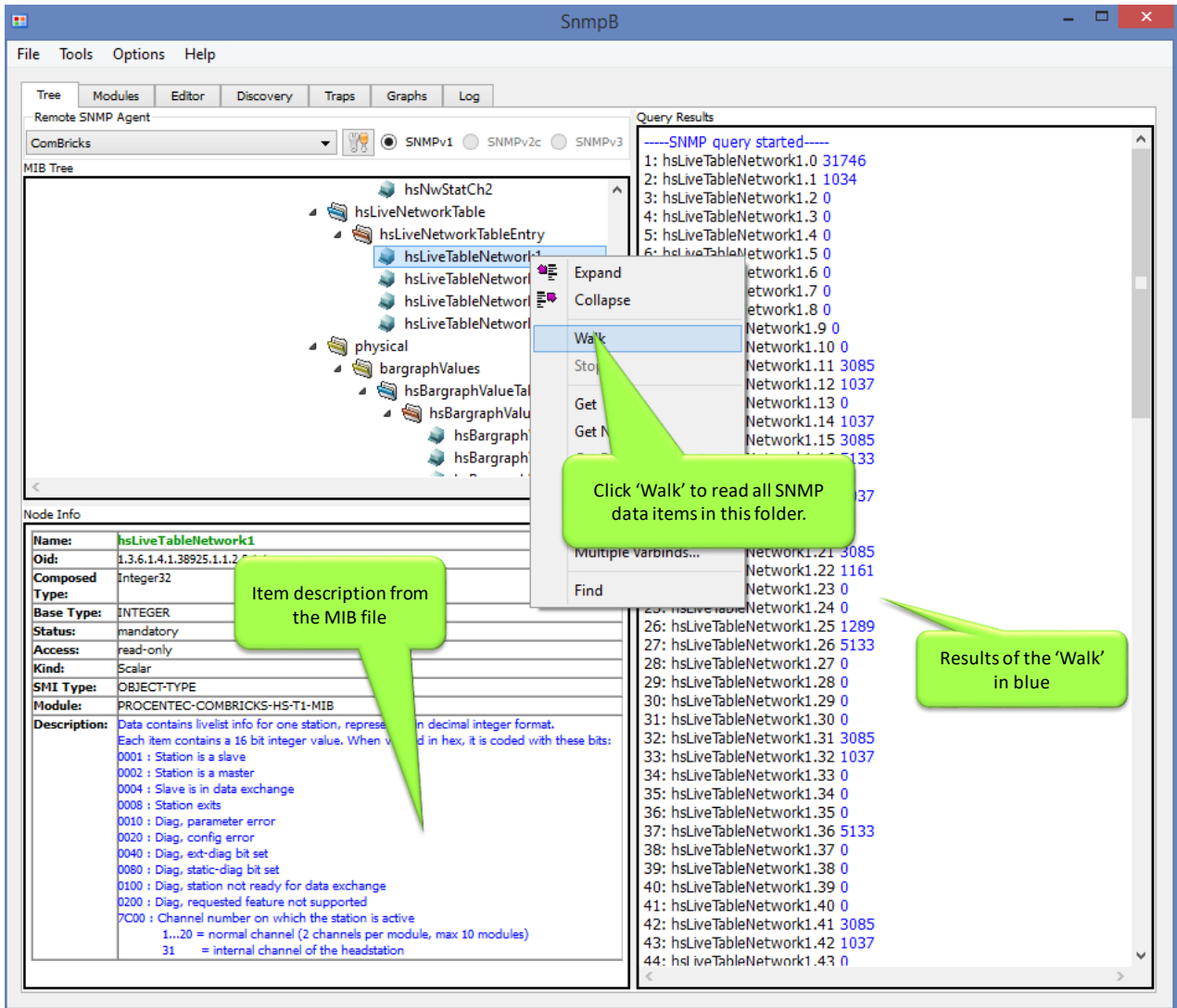

Fig. 114 - Example of reading SNMP data

The info panel of SNMPb shows the description and details of the selected SNMP item.

For other freeware SNMP tools, see **Paragraph 18.5**.

16.3 Viewing SNMP traps

SNMPb can also be used to view the SNMP traps that ComBricks can send. Make sure you have followed the procedure in paragraph 16.2, and set the IP address of the computer where SNMPb is running on as the trap recipient, in the SNMP Trap settings of ComBricks (see paragraph 5.5). Also make sure any firewall settings are set correctly (open UDP port 162 or custom port).

If you create an event that can be sent as SNMP trap, you will see that trap appear in the 'Trap' tab of SNMPb:

The screenshot shows the SnmpB application window with the 'Traps' tab selected. The 'Trap log' table contains the following data:

No	Date	Time	Timestamp	Notification Type	Message Type	Version	Agent Address	Agent port
0001	2018-03-22	11:06:30	0:35:22.50	externalPowerFailure	Trap(v2)	SNMPv2c	192.168.10.84	162
0002	2018-03-22	11:06:34	0:35:25.84	externalPowerRestored	Trap(v2)	SNMPv2c	192.168.10.84	162
0003	2018-03-22	11:06:39	0:35:27.41	externalPowerFailure	Trap(v2)	SNMPv2c	192.168.10.84	162
0004	2018-03-22	11:06:54	0:35:46.78	externalPowerRestored	Trap(v2)	SNMPv2c	192.168.10.84	162
0005	2018-03-22	11:09:02	0:37:54.38	externalPowerFailure	Trap(v2)	SNMPv2c	192.168.10.84	162
0006	2018-03-22	11:09:06	0:37:55.05	externalPowerRestored	Trap(v2)	SNMPv2c	192.168.10.84	162
0007	2018-03-22	11:09:11	0:37:55.73	redundantBalanceRestored	Trap(v2)	SNMPv2c	192.168.10.84	162
0008	2018-03-22	11:09:15	0:38:02.50	redundantBalanceDisrupted	Trap(v2)	SNMPv2c	192.168.10.84	162
0009	2018-03-22	11:09:25	0:38:17.91	externalPowerFailure	Trap(v2)	SNMPv2c	192.168.10.84	162
0010	2018-03-22	11:09:36	0:38:28.64	moduleRemovedFromSystem	Trap(v2)	SNMPv2c	192.168.10.84	162
0011	2018-03-22	11:09:42	0:38:34.76	moduleRemovedFromSystem	Trap(v2)	SNMPv2c	192.168.10.84	162
0012	2018-03-22	11:09:47	0:38:35.44	moduleReinsertedIntoSystem	Trap(v2)	SNMPv2c	192.168.10.84	162

The 'Trap info' panel for the selected trap (No. 0010) shows the following details:

- Name:** moduleRemovedFromSystem
- OID:** 1.3.6.1.4.1.38925.1.1.3.3.12
- Units:**
- Module:** PROCENTEC-COMBRICKS-HS-T1-MIB
- Reference:**
- Description:** A moduleRemovedFromSystem trap indicates a Power module has been removed from the ComBricks set. This event refers to module(s): PWR-SA (101-230010, Hardware revision V1.4 and newer)

The 'Trap content' panel shows the following message:

```
#0 trapInfo: Power module in slot 1 has been removed from the system
Community: trap
```

A green callout box points to the 'Description' field in the 'Trap info' panel, containing the text: "Trap descriptions coming from the MIB file".

Fig. 115 - Trap information in SNMPb

17 Firmware updates

The Updater tools and new firmware for the Head Station and for the modules can be downloaded from www.procentec.com/ComBricks.

Firmware files have the extension *.PKG*.

For updating the firmware of the Head Station a mini USB cable is required.
For updating modules an Ethernet connection to the ComBricks is required.

17.1 Updating the Head Station



The Firmware Update procedure requires a power-down of the ComBricks system. Modules will not be active during the update sequence. This means that the repeater functionality of the ComBricks is disabled and (parts of) the network will be down.

After downloading the firmware and installing the firmware update tool, follow the procedure below:

- STEP 1:** Shutdown ALL power to the Head Station (also USB cables and power modules).
- STEP 2:** Hold the menu switch of the Head Station down and at the same time provide power to the Head Station. In the firmware update mode the SF and IOF LEDs should be blinking.
- STEP 3:** Connect the mini USB to the Head Station (see **Fig. 116**).
- STEP 4:** Start the firmware update tool. If the tool detects the Head Station in the firmware update mode, the "Start update" button is enabled (see **Fig. 117**).
- STEP 5:** Click on "Start update" to browse to the *.PKG* file and click "OK". The tool will now upload the new firmware to the Head Station
- STEP 6:** After the upload the Head Station will update the firmware. This can take a few minutes.
The window that appears be can closed directly.
- STEP 7:** Verify the firmware update by checking the firmware version in the web server (bottom of each web page).



Fig. 116 - Firmware update cable

COMbricks headstation firmware update tool V1.5 (c) 2011 PROCENTEC

Steps to put the COMbricks headstation in firmware update mode:

1. Remove all power from the headstation.
(also remove the USB cable if connected)
2. While holding down the navigation button, re-apply the power.
(The red SF & IOF leds should now blink)
3. Connect the mini-usb cable to the headstation (and to a USB port on the PC).
(The green USB led should go on)

Current status: **Ok, COMbricks headstation connected and in firmware update mode.**

COMbricks is connected to USB and in the update mode

Click here to browse to the .pkg file

Warning

COMbricks is restarting

DO NOT remove the power until the led animation is finished!!

(this takes approx 3 minutes)

This window can be closed directly, but wait until COMbricks is ready (check LEDs)

Fig. 117 - Firmware update tool

17.2 Updating modules

Some ComBricks modules can get new functionality by updating the module firmware. These updates are not distributed through the Head Station firmware, but in separate Module firmware packages. For a listing of all available firmware, see www.procentec.com/ComBricks.

The tool for updating the module firmware is different than the tool for updating the Head Station. It can be downloaded from the above mentioned location.

After downloading the update tool and the module firmware follow the procedure below:

- STEP 1:** Make sure the Head Station and targeted module(s) are powered and running.
- STEP 2:** Connect an Ethernet cable between the Head Station and your workstation and verify the network connection.
- STEP 3:** Start the Module firmware update tool and enter the IP address of the targeted ComBricks Head Station. If you do not know the IP address, use 'Search network' to open the Discovery Tool and select the correct Head Station.
- STEP 4:** Click 'Connect to Head station' in the Update tool. It will scan all slots to check the module types.
- STEP 5:** Double-click the targeted module slot. A file dialog will appear; navigate to the local folder where you stored the firmware package.
- STEP 6:** The tool automatically filters all unrelated firmware files; you cannot select incorrect files. Choose the firmware and click 'Open'. The firmware update will start automatically. You should see the windows as shown in **Fig. 119** and **Fig. 118**.

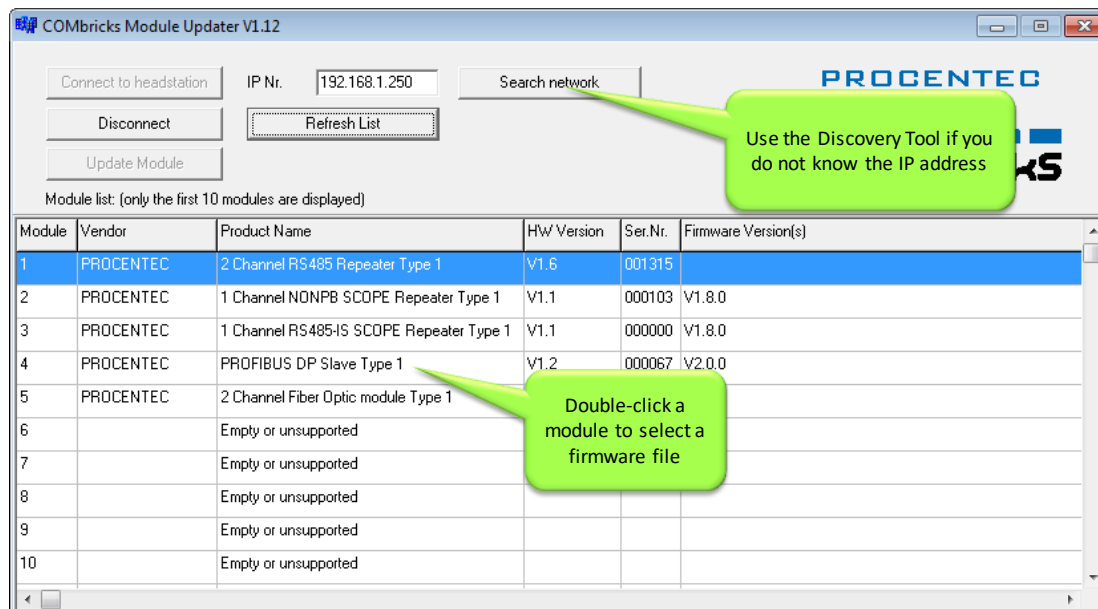

Fig. 119 - Updating module

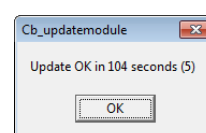

Fig. 118 - Update complete

18 Tips and Tricks

18.1 Ident Number lookup

It is possible to check if ComBricks has info on a certain Ident Number (located in gsd.bin):

[ComBricks IP or DNS address]/**data_srv.cgi?data=gsdinfo:0x**[Ident Number]

Example: *http://192.168.1.230/data_srv.cgi?data=gsdinfo:0x6012*

It should display a line comparable with this:

ABB%20Drives%20NPBA%2D12%1FABB%2DDRIVES%1F40%1F8%1FNPBA%2D12%.....

18.2 Solution for secured email connections

Because ComBricks can only handle unsecured email connections, a proxy between ComBricks email and outgoing email could be helpful. hMailserv is a free tool that creates a mail server on one of the local PCs in the network. ComBricks can mail the events to this mailserv and the mailserv can forward it through a secured connection to an external mailserv.

www.hmailserv.com

18.3 IP address adjustment tool

Every time you go 1-on-1 with a laptop to a ComBricks unit, the IP settings of your laptop have to be adjusted to fit the local IP address of the ComBricks. To make this step very easy a tool is available with the name NetSetMan to automatically change all the settings according to customized profiles.

www.netsetman.com

18.4 Free Wi-Fi channel detector

For ComBricks streaming with the ProfiTrace 2 software over Wi-Fi, a clean connection is required to keep the streaming performance as high as possible. To verify that your Wi-Fi does not overlap with other channels, we recommend to use the free tool inSSIDer.

www.metageek.net/products/inSSIDer

18.5 Some SNMP tools

To test the ComBricks SNMP functionality, you can use the tools below:

- SNMPb
- NetSentinel by Micromedia
- MIBbrowser by iReasoning
- Solarwinds

19 Technical Data - ComBricks in general

Technical Data - ComBricks in general	
Dimensions, weight and mounting	
Dimensions H x D x W (mm)	115 x 100 x 25 mm (1 module)
Weight	150 g
DIN-rail	35 mm (minimal 50 mm wide)
Ambient conditions	
Operating temperature	0 .. 60° C
Isolation class	IP 20 (DIN 40 050)
Colours and material	
Housing	RAL 5017 (blue) - ABS
Backplane	RAL 7037 (grey) - ABS
DIN rail clip	RAL 2004 (orange) - PP
Side cap	RAL 7024 (anthracite) - PP

20 Technical Data - Head Station 1A/1B/1C

Technical Data - Head Station 1A/1B/1C	
Type differences (Hardware is identical with all types)	
Head Station 1A	No ProfiTrace OE
Head Station 1B	ProfiTrace OE for 1 PROFIBUS network + ProfiTrace 2 live streaming + OPC (since June 2013)
Head Station 1C	ProfiTrace OE for 4 PROFIBUS networks + ProfiTrace 2 live streaming + OPC
For all Head Stations	CommDTM
Backplane	
Modules	32 (10 repeater modules positioned in the first 10 slots)
Current available for the backplane	2.5 A
PROFIBUS networks	4
Compatible backplane units	101-200012, 101-200023, 101-200024, 101-200027
Power supply specifications	
Power supply operating voltage range	12 to 24 VDC (tolerance range 11 to 26 VDC) Do not connect, if the power on backplane is supplied by a PWR-6A module.
Typical own Current consumption	73 mA at 24 VDC (externally powered) 230 mA at 5.72 VDC (externally or PWR-6A module powered)
Max. Current consumption	800 mA at 24 VDC (current consumption of other modules included)
Power dissipation	Max. 1.32 W (own power dissipation) Max. 20W (power dissipation of other modules included)
Reverse polarity protection	Yes
Redundant power supply	Yes
Wire diameter	< 2.5 mm ²
	<p>Installation notes:</p> <p>The device shall be supplied from an isolating transformer having a secondary Listed fuse rated either:</p> <ul style="list-style-type: none"> • Maximum 5 amps for voltages 12 to 20 V, or • Maximum 4 amps for voltages 21 to 24 V, <p>or is supplied by a Class 2 power supply, or equivalent.</p>

Technical Data - Head Station 1A/1B/1C

Ethernet

Connector	RJ-45
Cable length	Max. 100 m
Link speed	10 / 100 Mbps
MAC address	9C.B2.06.xx.xx.xx (label on the side of the Head Station)
Supported protocols	HTTP, FTP, SMTP, TELNET, DHCP, SNMP
Default IP address after reset/purchase	192.168.1.254
Connections	20 simultaneous web server clients

Relay contact

Resistance	300 mOhm (plug included)
Voltage	24 VAC
Current	0.5 A
	<u>Installation notes:</u> The Relay output shall be supplied from an isolating transformer having a secondary Listed fuse rated either: <ul style="list-style-type: none">• Maximum 5 amps for voltages 12 .. 20 V, or• Maximum 4 amps for voltages 21 .. 24 V, or is supplied by a Class 2 power supply, or equivalent.

SD Card

Types	SD and SDHC
Size	Max. 32 GB (1 GB is provided)

Connector Lay-out

Power supply	Plug-able screw connector, pitch 5,08 mm Pin - : 0 V Pin +: 24 VDC Pin SH: Shield SH connected internally to DIN-rail with spring-loaded contact
Alarm contact	Pin 1: NO Pin 2: NO potential-free relay contact, normally open

Others

Weight	150 g
MTBF	2873918 hours, at 30° Celsius, IEC TR 62380

Standards and approvals

CE

EMC Directive 2014/30/EU, class A Digital Device
RoHS Directive 2011/65/EU

FCC

47 CFR 15, Unintentional Radiator, class A Digital Device.

UL

Report reference: E468970

Standards for safety: UL 508 - Industrial Control Equipment CSA
C22.2 No. 142-M1987 - Industrial Control Equipment

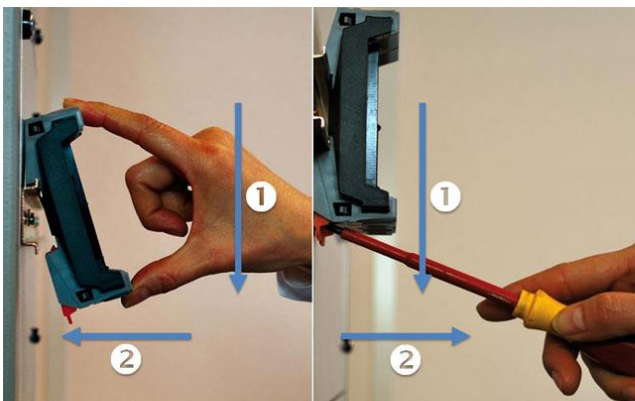

Mounting and un-mounting backplanes

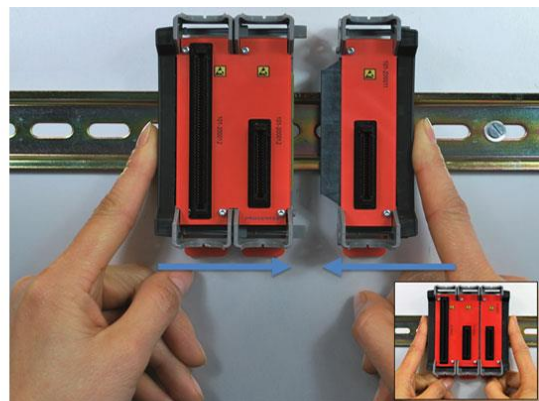

Adding additional backplanes

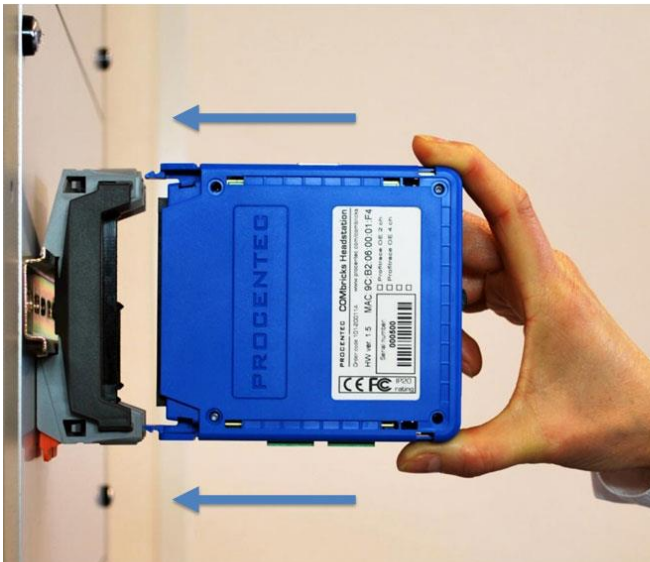

Inserting modules



Powering the Head Station

21 Technical Data - SCOPE Repeater (101-201210)

Technical Data - SCOPE Repeater (101-201210)																			
Dimensions and weight																			
Dimensions L x W x H	137 x 25 x 103 mm (including backplane, per module)																		
Weight	120 g (excluding plug-able connectors, backplane and packing material)																		
Mounting DIN-rail type	35mm x 7.5mm (EN 50022, BS 5584, DIN 46277-3)																		
Ambient conditions																			
Ambient operating temperature range	-20° ... +60° Celsius (for mounting position see manual) -4° ... 158° Fahrenheit																		
Isolating class	IP 20 (IEC/EN 60529, DIN 40050)																		
Backplane																			
PROFIBUS networks	4 (set by dipswitches or web server)																		
Modules	10 (positioned in the first 10 slots)																		
Power supply	Provided through the backplane																		
Typical backplane current consumption	400 mA (at 5.72 VDC)																		
Max. backplane current consumption	600 mA (at 5.72 VDC) At this current consumption the module is switched OFF from backplane. Occurs when module is faulty, e.g. internal short circuit.																		
Compatible backplane units	101-200011, 101-200022, 101-200023, 101-200024, 101-200027																		
Protocol specifications																			
Supported Protocols	DP-V0, DP- V1, DP-V2, FDL, MPI, FMS, PROFIsafe, PROFIdrive and any other FDL based protocol																		
Address	NO bus address required																		
Transmission speed	9.6 kbps .. 12 Mbps (including 45.45 kbps)																		
Transmission speed detection	Auto detect (< 10 s detection and 50 s baudrate switchover time)																		
Data delay time	<table border="1"> <thead> <tr> <th>At baudrate</th> <th>Normal mode</th> <th>Redundant mode</th> </tr> </thead> <tbody> <tr> <td>9.6 - 500 kbps</td> <td>2.8 Tbit</td> <td>13.8 Tbit</td> </tr> <tr> <td>1.5 Mbps</td> <td>3.2 Tbit</td> <td>14.2 Tbit</td> </tr> <tr> <td>3 Mbps</td> <td>3.9 Tbit</td> <td>14.5 Tbit</td> </tr> <tr> <td>6 Mbps</td> <td>4.6 Tbit</td> <td>15.6 Tbit</td> </tr> <tr> <td>12 Mbps</td> <td>6.4 Tbit</td> <td>17.4 Tbit</td> </tr> </tbody> </table>	At baudrate	Normal mode	Redundant mode	9.6 - 500 kbps	2.8 Tbit	13.8 Tbit	1.5 Mbps	3.2 Tbit	14.2 Tbit	3 Mbps	3.9 Tbit	14.5 Tbit	6 Mbps	4.6 Tbit	15.6 Tbit	12 Mbps	6.4 Tbit	17.4 Tbit
At baudrate	Normal mode	Redundant mode																	
9.6 - 500 kbps	2.8 Tbit	13.8 Tbit																	
1.5 Mbps	3.2 Tbit	14.2 Tbit																	
3 Mbps	3.9 Tbit	14.5 Tbit																	
6 Mbps	4.6 Tbit	15.6 Tbit																	
12 Mbps	6.4 Tbit	17.4 Tbit																	
Deviation	2 bit times (over the complete message) for received messages is allowed and is corrected to nominal speed when transmitted.																		

Technical Data - SCOPE Repeater (101-201210)

Oscilloscope specifications

Frequency	192 MS/s
Resolution	50 mV
Differential range	-6.436 .. 6.436 V

PROFIBUS cable specifications

Cable lengths	1200 m at 9.6 kbps to 93.75 kbps 1000 m at 187.5 kbps 400 m at 500 kbps 200 m at 1.5 Mbps 100 m at 3 Mbps to 12 Mbps																						
Wire diameter (for the screw terminals) Wire type	< 2.5 mm ² Stranded or solid core																						
Number of devices	Maximum 31 devices per channel (busload)																						
Termination	Integrated and switchable Powered according to PB RS 485 (390/220/390 Ohms)																						
Redundancy	Yes, maximum 10 cables activated by switch																						
Cascading depth	No limit (only limited by busparameter of the master)																						
Cascading units	With standard busparameters: <table border="1"> <thead> <tr> <th>At baudrate</th> <th>Normal mode[units]</th> </tr> </thead> <tbody> <tr> <td>9.6 kbps</td> <td>7</td> </tr> <tr> <td>19.2 kbps</td> <td>7</td> </tr> <tr> <td>45.45 kbps</td> <td>42</td> </tr> <tr> <td>93.75 kbps</td> <td>7</td> </tr> <tr> <td>187.5 kbps</td> <td>7</td> </tr> <tr> <td>500 kbps</td> <td>17</td> </tr> <tr> <td>1.5 Mbps</td> <td>23</td> </tr> <tr> <td>3 Mbps</td> <td>19</td> </tr> <tr> <td>6 Mbps</td> <td>16</td> </tr> <tr> <td>12 Mbps</td> <td>15</td> </tr> </tbody> </table> <p>Formula to calculate number of cascading units with adjusted T_{slot} : Cascading units = $(T_{slot} - \max T_{sdr}) / (2 \times T_{data_delay_time})$ $T_{data_delay_time}$ is described in protocol specifications on previous page. Example 1.5 Mbps, normal mode: Cascading units = $(300-150) / (2 \times 3.2) = 23$</p>	At baudrate	Normal mode[units]	9.6 kbps	7	19.2 kbps	7	45.45 kbps	42	93.75 kbps	7	187.5 kbps	7	500 kbps	17	1.5 Mbps	23	3 Mbps	19	6 Mbps	16	12 Mbps	15
At baudrate	Normal mode[units]																						
9.6 kbps	7																						
19.2 kbps	7																						
45.45 kbps	42																						
93.75 kbps	7																						
187.5 kbps	7																						
500 kbps	17																						
1.5 Mbps	23																						
3 Mbps	19																						
6 Mbps	16																						
12 Mbps	15																						

Connector Lay-out

PROFIBUS screw terminal CH1	<u>Plug-able screw terminal, pitch 5,08 mm</u> Pin A: PROFIBUS A (green wire) Pin B: PROFIBUS B (red wire) Pin SH: Shield
-----------------------------	--

Technical Data - SCOPE Repeater (101-201210)

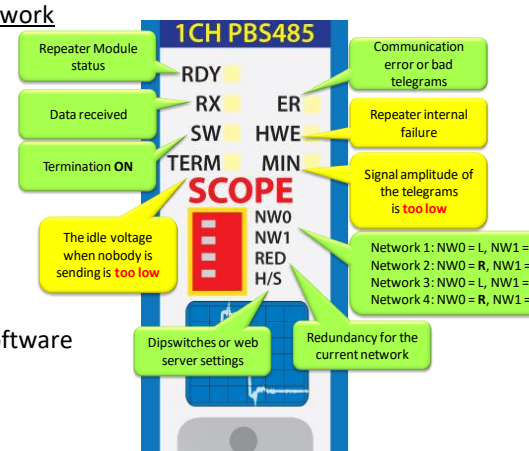
<p>PROFIBUS DB9 CH1</p>	<p>Pin I: Indirect Shield</p> <p><u>D Sub connector, 9 contacts (PROFIBUS specification)</u></p> <p>Pin 1: N.C. Pin 2: N.C. Pin 3: PROFIBUS - B Pin 4: PROFIBUS - RTS Pin 5: GND Pin 6: VPP Pin 7: N.C. Pin 8: PROFIBUS - A Pin 9: N.C. Housing: Shield</p> <p><i>Pin SH is connected internally to the DIN-rail with spring-loaded contact.</i></p> <p><i>Pin I is connected internally with 10nF/1MOhm to shield.</i></p>
LEDs	
<p>RDY : Ready RX : Receiving SW : Switch Network Termination HWE : Hardware Error ER : Error MIN : Minus TERM : Termination voltage</p>	<p>Module is ready for operation (ON) Receiving telegrams (blinking) Network Termination active (ON) Internal repeater error (ON contact PROCENTEC) No or bad receiving telegrams detected (ON or blinking) Signal amplitude of the telegrams too low < 2.5 V (ON) Idle voltage too low <0.95 V or >1.26 V (ON)</p> <p><i>Alarm values can be changed through the web server.</i></p>
Dipswitches	
<p><u>NW0</u> <u>NW1</u> LEFT LEFT RIGHT LEFT LEFT RIGHT RIGHT RIGHT</p> <p><u>RED</u> LEFT / RIGHT</p> <p><u>H/S</u> LEFT / RIGHT</p>	<p><u>PROFIBUS Network</u></p> <p>1 2 3 4</p> <p><u>Redundancy</u> OFF / ON</p> <p><u>Settings</u> Hardware / Software</p>  <p>The diagram shows the 1CH PBS485 module with the following callouts:</p> <ul style="list-style-type: none"> Repeater Module status (RDY) Data received (RX) Termination ON (TERM) Communication error or bad telegrams (ER) Repeater internal failure (HWE) Signal amplitude of the telegrams is too low (MIN) The idle voltage when nobody is sending is too low (MIN) Network 1: NW0 = L, NW1 = L Network 2: NW0 = R, NW1 = L Network 3: NW0 = L, NW1 = R Network 4: NW0 = R, NW1 = R Dipswitches or web server settings (NW0, NW1, RED, H/S) Redundancy for the current network (H/S)

Technical Data - SCOPE Repeater (101-201210)

Standard and approvals

CE	EMC Directive 2014/30/EU, class A Digital Device RoHs Directive 2011/65/EU
FCC	47 CFR 15, Unintentional Radiator, class A Digital Device.
UL	Report reference: E468970 Standards for safety: UL 508 - Industrial Control Equipment. CSA C22.2 No. 142-M1987 - Industrial Control Equipment

Others

Head Station firmware MTBF	At least version 1.260 1123748 hours, at 30° Celsius, IEC TR 62380
-------------------------------	---

PROCEN TEC Klopperman 16 2292 JD WATERINGEN (NL)	Tel.: +31-174-671800 Fax: +31-174-671801 Email: info@procentec.com
---	---

22 Technical Data - 2 Channel Repeater (101-201102)

Technical Data - 2 Channel Repeater (101-201102)																			
Dimensions and weight																			
Dimensions L x W x H	137 x 25 x 105 mm (including backplane, per module)																		
Weight	119 g (excluding plug-able connectors, backplane and packing material)																		
Mounting DIN-rail type	35mm x 7.5mm (EN 50022, BS 5584, DIN 46277-3)																		
Ambient conditions																			
Ambient operating temperature range	-20° ... +60° Celsius (for mounting position see manual) -4° ... 158° Fahrenheit																		
Isolating class	IP 20 (IEC/EN 60529, DIN 40050)																		
Backplane																			
PROFIBUS networks	4 (set by dipswitches or web server)																		
Modules	10 (positioned in the first 10 slots)																		
Power supply	Provided through the backplane																		
Typical backplane current consumption	300 mA (at 5.72 VDC)																		
Max. backplane current consumption	500 mA (at 5.72 VDC) At this current consumption the module is switched OFF from backplane. Occurs when module is faulty, e.g. internal short circuit.																		
Compatible backplane units	101-200011, 101-200022, 101-200023, 101-200024, 101-200027																		
Protocol specifications																			
Supported Protocols	DP-V0, DP- V1, DP-V2, FDL, MPI, FMS, PROFIsafe, PROFIdrive and any other FDL based protocol																		
Address	NO bus address required																		
Transmission speed	9.6 kbps .. 12 Mbps (including 45.45 kbps)																		
Transmission speed detection	Auto detect (< 10 s detection and 50 s baudrate switchover time)																		
Data delay time	<table border="1"> <thead> <tr> <th>At baudrate</th> <th>Normal mode</th> <th>Redundant mode</th> </tr> </thead> <tbody> <tr> <td>9.6 - 500 kbps</td> <td>2.8 Tbit</td> <td>13.8 Tbit</td> </tr> <tr> <td>1.5 Mbps</td> <td>3.2 Tbit</td> <td>14.2 Tbit</td> </tr> <tr> <td>3 Mbps</td> <td>3.9 Tbit</td> <td>14.5 Tbit</td> </tr> <tr> <td>6 Mbps</td> <td>4.6 Tbit</td> <td>15.6 Tbit</td> </tr> <tr> <td>12 Mbps</td> <td>6.4 Tbit</td> <td>17.4 Tbit</td> </tr> </tbody> </table>	At baudrate	Normal mode	Redundant mode	9.6 - 500 kbps	2.8 Tbit	13.8 Tbit	1.5 Mbps	3.2 Tbit	14.2 Tbit	3 Mbps	3.9 Tbit	14.5 Tbit	6 Mbps	4.6 Tbit	15.6 Tbit	12 Mbps	6.4 Tbit	17.4 Tbit
At baudrate	Normal mode	Redundant mode																	
9.6 - 500 kbps	2.8 Tbit	13.8 Tbit																	
1.5 Mbps	3.2 Tbit	14.2 Tbit																	
3 Mbps	3.9 Tbit	14.5 Tbit																	
6 Mbps	4.6 Tbit	15.6 Tbit																	
12 Mbps	6.4 Tbit	17.4 Tbit																	
Deviation	2 bit times (over the complete message) for received messages is allowed and is corrected to nominal speed when transmitted.																		
PROFIBUS cable specifications																			

Technical Data - 2 Channel Repeater (101-201102)

Cable lengths	1200 m at 9.6 kbps to 93.75 kbps 1000 m at 187.5 kbps 400 m at 500 kbps 200 m at 1.5 Mbps 100 m at 3 Mbps to 12 Mbps																						
Wire diameter (for the screw terminals) Wire type	< 2.5 mm ² Stranded or solid core																						
Number of devices	Maximum 31 devices per channel (busload)																						
Termination	Integrated and switchable Powered according to PB RS 485 (390/220/390 Ohms)																						
Redundancy	Yes, maximum 10 cables activated by switch																						
Cascading depth	No limit (only limited by busparameter of the master)																						
Cascading units	<p>With standard busparameters:</p> <table border="1"> <thead> <tr> <th>At baudrate</th> <th>Normal mode[units]</th> </tr> </thead> <tbody> <tr><td>9.6 kbps</td><td>7</td></tr> <tr><td>19.2 kbps</td><td>7</td></tr> <tr><td>45.45 kbps</td><td>42</td></tr> <tr><td>93.75 kbps</td><td>7</td></tr> <tr><td>187.5 kbps</td><td>7</td></tr> <tr><td>500 kbps</td><td>17</td></tr> <tr><td>1.5 Mbps</td><td>23</td></tr> <tr><td>3 Mbps</td><td>19</td></tr> <tr><td>6 Mbps</td><td>16</td></tr> <tr><td>12 Mbps</td><td>15</td></tr> </tbody> </table> <p>Formula to calculate number of cascading units with adjusted T_{slot} :</p> $\text{Cascading units} = (T_{slot} - \max T_{sdr}) / (2 \times T_{data_delay_time})$ <p>$T_{data_delay_time}$ is described in protocol specifications on previous page.</p> <p>Example 1.5 Mbps, normal mode:</p> $\text{Cascading units} = (300-150) / (2 \times 3.2) = 23$	At baudrate	Normal mode[units]	9.6 kbps	7	19.2 kbps	7	45.45 kbps	42	93.75 kbps	7	187.5 kbps	7	500 kbps	17	1.5 Mbps	23	3 Mbps	19	6 Mbps	16	12 Mbps	15
At baudrate	Normal mode[units]																						
9.6 kbps	7																						
19.2 kbps	7																						
45.45 kbps	42																						
93.75 kbps	7																						
187.5 kbps	7																						
500 kbps	17																						
1.5 Mbps	23																						
3 Mbps	19																						
6 Mbps	16																						
12 Mbps	15																						
Connector Lay-out																							
PROFIBUS SCREW Terminal CH1 and CH2	<u>Plug-able screw terminal, pitch 5,08 mm</u> Pin A: PROFIBUS A (green wire) Pin B: PROFIBUS B (red wire) Pin SH: Shield Pin I: Indirect Shield																						
PROFIBUS DB9 CH2	<u>D Sub connector, 9 contacts (PROFIBUS specification)</u> Pin 1: N.C. Pin 2: N.C. Pin 3: PROFIBUS - B Pin 4: PROFIBUS - RTS																						

Technical Data - 2 Channel Repeater (101-201102)

	<p>Pin 5: GND Pin 6: VPP Pin 7: N.C. Pin 8: PROFIBUS - A Pin 9: N.C. Housing: Shield</p> <p><i>Pin SH is connected internally to the DIN-rail with spring-loaded contact.</i> <i>Pin I is connected internally with 10nF/1MOhm to shield.</i></p>
--	---

LEDs

<p>RDY : Ready RX : Receiving ER : Error Receiving SW : Switch Network Termination</p>	<p>Module is ready for operation (ON) Receiving telegrams (blinking) No or bad receiving telegrams detected (ON or blinking) Network termination active (ON)</p>
---	---

Dipswitches

<p><u>NW0</u> <u>NW1</u> LEFT LEFT RIGHT LEFT LEFT RIGHT RIGHT RIGHT</p> <p><u>RED</u> LEFT RIGHT</p> <p><u>H/S</u> LEFT RIGHT</p>	<p><u>PROFIBUS Network</u> 1 2 3 4</p> <p><u>Redundancy</u> OFF ON</p> <p><u>Settings</u> Hardware Software</p>	<p>The diagram shows the physical layout of the module. Callouts include: 'Repeater Module status' pointing to RDY; 'Data received on Channel x' pointing to RX2; 'Channel 2 and Channel 1' pointing to RX1; 'Dipswitches or web server settings' pointing to the bottom dipswitches; 'Termination ON on Channel x' pointing to SW2; 'Communication error on Channel x' pointing to ER2; 'Network 1: NW0 = L, NW1 = L; Network 2: NW0 = R, NW1 = L; Network 3: NW0 = L, NW1 = R; Network 4: NW0 = R, NW1 = R' pointing to the top dipswitches; and 'Redundancy for the current network' pointing to the bottom dipswitches.</p>
--	---	---

Standard and approvals

CE	EMC Directive 2014/30/EU, class A Digital Device RoHs Directive 2011/65/EU
FCC	47 CFR 15, Unintentional Radiator, class A Digital Device.
UL	Report reference: E468970 Standards for safety: UL 508 - Industrial Control Equipment, CSA C22.2 No. 142-M1987 - Industrial Control Equipment

Others

Head Station firmware MTBF	ALL 1448431 hours, at 30° Celsius, IEC TR 62380
-------------------------------	--

23 Technical Data - 1 Channel Repeater (101-201101)

Technical Data - 1 Channel Repeater (101-201101)																			
Dimensions and weight																			
Dimensions L x W x H	137 x 25 x 103 mm (including backplane, per module)																		
Weight	112 g (excluding plug-able connectors, backplane and packing material)																		
Mounting DIN-rail type	35mm x 7.5mm (EN 50022, BS 5584, DIN 46277-3)																		
Ambient conditions																			
Ambient operating temperature range	-20° ... +60° Celsius (for mounting position see manual) -4° ... 158° Fahrenheit																		
Isolating class	IP 20 (IEC/EN 60529, DIN 40050)																		
Backplane																			
PROFIBUS networks	4 (set by dipswitches or web server)																		
Modules	10 (positioned in the first 10 slots)																		
Power supply	Provided through the backplane																		
Typical backplane current consumption	300 mA (at 5.72 VDC)																		
Max. backplane current consumption	500 mA (at 5.72 VDC) At this current consumption the module is switched OFF from backplane. Occurs when module is faulty, e.g. internal short circuit.																		
Compatible backplane units	101-200011, 101-200022, 101-200023, 101-200024, 101-200027																		
Protocol specifications																			
Supported Protocols	DP-V0, DP- V1, DP-V2, FDL, MPI, FMS, PROFIsafe, PROFIdrive and any other FDL based protocol																		
Address	NO bus address required																		
Transmission speed	9.6 kbps .. 12 Mbps (including 45.45 kbps)																		
Transmission speed detection	Auto detect (< 10 s detection and 50 s baudrate switchover time)																		
Data delay time	<table border="1"> <thead> <tr> <th>At baudrate</th> <th>Normal mode</th> <th>Redundant mode</th> </tr> </thead> <tbody> <tr> <td>9.6 - 500 kbps</td> <td>2.8 Tbit</td> <td>13.8 Tbit</td> </tr> <tr> <td>1.5 Mbps</td> <td>3.2 Tbit</td> <td>14.2 Tbit</td> </tr> <tr> <td>3 Mbps</td> <td>3.9 Tbit</td> <td>14.5 Tbit</td> </tr> <tr> <td>6 Mbps</td> <td>4.6 Tbit</td> <td>15.6 Tbit</td> </tr> <tr> <td>12 Mbps</td> <td>6.4 Tbit</td> <td>17.4 Tbit</td> </tr> </tbody> </table>	At baudrate	Normal mode	Redundant mode	9.6 - 500 kbps	2.8 Tbit	13.8 Tbit	1.5 Mbps	3.2 Tbit	14.2 Tbit	3 Mbps	3.9 Tbit	14.5 Tbit	6 Mbps	4.6 Tbit	15.6 Tbit	12 Mbps	6.4 Tbit	17.4 Tbit
At baudrate	Normal mode	Redundant mode																	
9.6 - 500 kbps	2.8 Tbit	13.8 Tbit																	
1.5 Mbps	3.2 Tbit	14.2 Tbit																	
3 Mbps	3.9 Tbit	14.5 Tbit																	
6 Mbps	4.6 Tbit	15.6 Tbit																	
12 Mbps	6.4 Tbit	17.4 Tbit																	
Deviation	2 bit times (over the complete message) for received messages is allowed and is corrected to nominal speed when transmitted.																		

Technical Data - 1 Channel Repeater (101-201101)

PROFIBUS cable specifications

Cable lengths	1200 m at 9.6 kbps to 93.75 kbps 1000 m at 187.5 kbps 400 m at 500 kbps 200 m at 1.5 Mbps 100 m at 3 Mbps to 12 Mbps																						
Wire diameter (for the screw terminals) Wire type	< 2.5 mm ² Stranded or solid core																						
Number of devices	Maximum 31 devices per channel (busload)																						
Termination	Integrated and switchable Powered according to PB RS 485 (390/220/390 Ohms)																						
Redundancy	Yes, maximum 10 cables activated by switch																						
Cascading depth	No limit (only limited by busparameter of the master)																						
Cascading units	<p>With standard busparameters:</p> <table border="1"> <thead> <tr> <th>At baudrate</th> <th>Normal mode[units]</th> </tr> </thead> <tbody> <tr><td>9.6 kbps</td><td>7</td></tr> <tr><td>19.2 kbps</td><td>7</td></tr> <tr><td>45.45 kbps</td><td>42</td></tr> <tr><td>93.75 kbps</td><td>7</td></tr> <tr><td>187.5 kbps</td><td>7</td></tr> <tr><td>500 kbps</td><td>17</td></tr> <tr><td>1.5 Mbps</td><td>23</td></tr> <tr><td>3 Mbps</td><td>19</td></tr> <tr><td>6 Mbps</td><td>16</td></tr> <tr><td>12 Mbps</td><td>15</td></tr> </tbody> </table> <p>Formula to calculate number of cascading units with adjusted T_{slot} :</p> $\text{Cascading units} = (T_{slot} - \max T_{sdr}) / (2 \times T_{data_delay_time})$ <p>$T_{data_delay_time}$ is described in protocol specifications on previous page.</p> <p>Example 1.5 Mbps, normal mode: Cascading units = $(300-150) / (2 \times 3.2) = 23$</p>	At baudrate	Normal mode[units]	9.6 kbps	7	19.2 kbps	7	45.45 kbps	42	93.75 kbps	7	187.5 kbps	7	500 kbps	17	1.5 Mbps	23	3 Mbps	19	6 Mbps	16	12 Mbps	15
At baudrate	Normal mode[units]																						
9.6 kbps	7																						
19.2 kbps	7																						
45.45 kbps	42																						
93.75 kbps	7																						
187.5 kbps	7																						
500 kbps	17																						
1.5 Mbps	23																						
3 Mbps	19																						
6 Mbps	16																						
12 Mbps	15																						

Connector Lay-out

PROFIBUS SCREW Terminal CH1	<p><u>Plug-able screw terminal, pitch 5,08 mm</u></p> <p>Pin A: PROFIBUS A (green wire) Pin B: PROFIBUS B (red wire) Pin SH: Shield Pin I: Indirect Shield</p>
PROFIBUS DB9 CH1	<p><u>D Sub connector, 9 contacts (PROFIBUS specification)</u></p> <p>Pin 1: N.C. Pin 2: N.C. Pin 3: PROFIBUS - B Pin 4: PROFIBUS - RTS</p>

Technical Data - 1 Channel Repeater (101-201101)

Pin 5: GND
 Pin 6: VPP
 Pin 7: N.C.
 Pin 8: PROFIBUS - A
 Pin 9: N.C.
 Housing: Shield

Pin SH is connected internally to the DIN-rail with spring-loaded contact.
Pin I is connected internally with 10nF/1MOhm to shield.

LEDs

RDY : Ready
 RX : Receiving
 ER : Error Receiving
 SW : Switch Network Termination

Module is ready for operation (ON)
 Receiving telegrams (blinking)
 No or bad receiving telegrams detected (ON or blinking)
 Network termination active (ON)

Dipswitches

NW0 NW1
 LEFT LEFT
 RIGHT LEFT
 LEFT RIGHT
 RIGHT RIGHT

RED
 LEFT
 RIGHT

H/S
 LEFT
 RIGHT

PROFIBUS Network

1
 2
 3
 4

Redundancy
 OFF
 ON

Settings
 Hardware
 Software

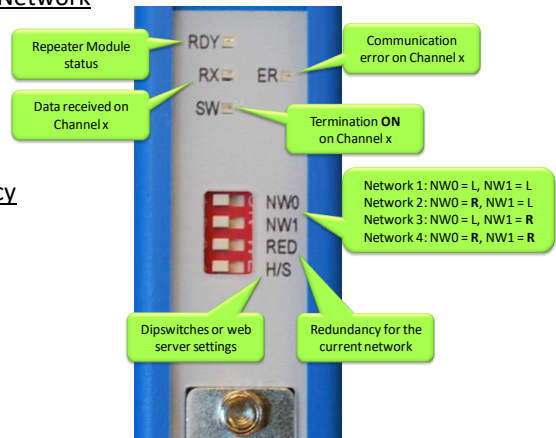

Standard and approvals

CE

EMC Directive 2014/30/EU, class A Digital Device
 RoHs Directive 2011/65/EU

FCC

47 CFR 15, Unintentional Radiator, class A Digital Device.

UL

Report reference: E468970
 Standards for safety: UL 508 - Industrial Control Equipment, CSA C22.2 No. 142-M1987 - Industrial Control Equipment

Others

Head Station firmware
 MTBF

ALL
 2595178 hours, at 30° Celsius, IEC TR 62380

24 Technical Data - Fiber Optic Module (101-201510)

Dimensions and weight	
Dimensions L x W x H	146 x 25 x 101 mm (including backplane)
Weight	121 g (excluding plug-able fiber optic connector and packing material)
Mounting DIN-rail type	35mm x 7,5mm (EN 50022, BS 5584, DIN 46277-3)
Ambient conditions	
Operating temperature range	0° to +60° Celsius (for mounting position see manual) 32° to +140° Fahrenheit
Isolation class	IP 20 (IEC/EN 60529, DIN 40050)
Backplane	
PROFIBUS networks	4 (set by dipswitches or web server)
Modules	Max. 10 (positioned in the first 10 slots)
Power supply	Provided through the backplane
Typical backplane current at 5.75 VDC	360 mA
Max. backplane current at 5.75 VDC	510 mA (At this current consumption the module is switched OFF from backplane. Occurs when module is faulty, e.g. internal short circuit.)
Compatible backplane units	101-200011, 101-200022, 101-200023, 101-200024, 101-200027
Protocol specifications	
Supported Protocols	DP-V0, DP- V1, DP-V2, FDL, MPI, FMS, PROFIsafe, PROFIdrive and any other FDL based protocol
Address	No bus address required
Transmission speed	9.6 kbps ... 12 Mbps (including 45.45 kbps)
Transmission speed detection time	Auto detect (< 10 s detection and 50 s baudrate switchover time)
Total delay (Normal and Robust mode)	$T_{\text{SLOT}} \geq \text{Max}T_{\text{SDR}} + ((\text{FO}_{\text{length}} \times \text{FO}_{\text{delay}}) + (\text{N}_{\text{FO-modules}} \times \text{N}_{\text{delay}})) \times 2$ <p> $\text{FO}_{\text{length}}$ = Total length of fiber optic cable in km FO_{delay} = Delay of fiber optic cable per km in bit times (see table) $\text{N}_{\text{FO-modules}}$ = Number of fiber optic modules in a line N_{delay} = Delay of one fiber optic module (see table) </p> <p>The delay time is multiplied by 2 for a request and response message.</p>

Baudrate	Max _{TSDR} [Tbit]	FO _{delay} [Tbit/km]	N _{delay} Normal mode [Tbit]	N _{delay} Redundant mode [Tbit]
12 Mbps	800	60	7	16
6 Mbps	450	30	5	16
3 Mbps	250	15	4.5	15
1.5 Mbps	150	7.5	4	15
500 kbps	100	2.5	3	14
187.5 kbps	60	0.94	3	14
93.75 kbps	60	0.47	3	14
45.45 kbps	400	0.23	3	14
19.2 kbps	60	0.1	3	14
9.6 kbps	60	0.05	3	14

Note

$$FO_{delay} = (FO_{cable_length} / FO_{cable\ latency}) / Bit_{time}$$

example FO_{delay}, 1km, 1.5Mbps:

$$FO_{delay} = (1000\ m / 200\ \mu sec/m) / 0.666\ \mu sec = 7.5\ Tbit/km$$

Example 1: 1.5 Mbps, 3 km FO cable, 2 FO modules normal mode

$$T_{SLOT} \geq Max_{TSDR} + ((FO_{length} \times FO_{delay}) + (N_{FO-modules} \times N_{delay})) \times 2$$

$$T_{SLOT} \geq 150 + ((3 \times 7.5) + (2 \times 4)) \times 2 \geq \mathbf{211\ bit\ times}$$

Example 2: 1.5 Mbps, 3 km FO cable, 2 FO modules redundant mode

$$T_{SLOT} \geq Max_{TSDR} + ((FO_{length} \times FO_{delay}) + (N_{FO-modules} \times N_{delay})) \times 2$$

$$T_{SLOT} \geq 150 + ((3 \times 7.5) + (2 \times 15)) \times 2 \geq \mathbf{255\ bit\ times}$$

Example 3: 6 Mbps, 10 km FO cable (total line length), 10 FO modules in line

$$T_{SLOT} \geq Max_{TSDR} + ((FO_{length} \times FO_{delay}) + (N_{FO-modules} \times N_{delay})) \times 2$$

$$T_{SLOT} \geq 450 + ((10 \times 30) + (10 \times 5)) \times 2 \geq \mathbf{800\ bit\ times}$$

Jitter per message frame

Deviation

0.0625 Tbit at 9.6 Kbps - 3 Mbps

0.125 Tbit at 6 Mbps

0.25 Tbit at 12 Mbps

2 Tbit times for received messages is allowed and is corrected to nominal speed when transmitted (*over the complete message*)

Fiber optic specifications

Fiber Optic wavelength	Multimode 850 nm (Compatible with most other vendors in 3rd party compatibility mode)
Cable type	Multimode Fiber G62.5 (50) / 125 μm (OM1)
Cable length	Max. 3 km (baudrate independent)
Connectors	4 x ST/BFOC (2 channels)
Topologies	Point-to-point, Star and Bus
Cascading depth	No limit, only busparameter limitation of the master
Redundancy	Maximum 10 cables activated by Dip-Switch

DIP-Switches

<u>NW0</u>	<u>NW1</u>	<u>PROFIBUS Network</u>
LEFT	LEFT	1
RIGHT	LEFT	2
LEFT	RIGHT	3
RIGHT	RIGHT	4
<u>RED</u>		<u>Redundancy</u>
LEFT		OFF
RIGHT		ON
<u>H/S</u>		<u>Settings</u>
LEFT		Hardware
RIGHT		Software

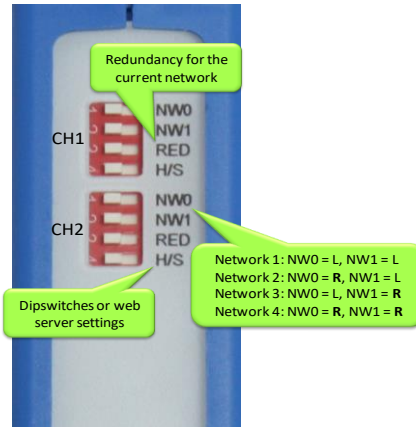

LEDs

	OFF	Blinking	ON
RDY	☹️ Module has NOT been powered / initialized yet.	😐 Head Station is initializing or updating the module.	😊 Module has been initialized and is operational
RX1 / RX2	😐 NO signal, or NO valid telegrams detected on this channel, or channel is off.	😊 1 or more devices are communicating on this channel.	😊 1 or more devices are communicating on this channel.
ER1 / ER2	😊 No errors, or channel is off.	☹️ Problem in the cabling / communication has been detected on this channel.	☹️ No baudrate detected or no connection/signal

Standard and approvals

CE	EMC Directive 2014/30/EU, class A Digital Device RoHs Directive 2011/65/EU
FCC	47 CFR 15, Unintentional Radiator, class A Digital Device.
UL	Report reference: E468970 Standards for safety: UL 508 - Industrial Control Equipment CSA C22.2 No. 142-M1987 - Industrial Control Equipment

Others

Head Station firmware	1.264 and higher
-----------------------	------------------

25 Technical Data - Fiber Optic Ring MM1 (101-201530)

Dimensions and weight	
Dimensions L x W x H	146 x 25 x 101 mm (including backplane)
Weight	121 g (excluding plug-able fiber optic connector and packing material)
Mounting DIN-rail type	35mm x 7,5mm (EN 50022, BS 5584, DIN 46277-3)
Ambient conditions	
Operating temperature range	0° to +60° Celsius (for mounting position see manual) 32° to +140° Fahrenheit
Isolation class	IP 20 (IEC/EN 60529, DIN 40050)
Backplane	
PROFIBUS networks	4 (set by dipswitches or web server)
Modules	Max. 10 (positioned in the first 10 slots)
Power supply	Provided through the backplane
Typical backplane current at 5.75 VDC	400 mA (at 5.72 VDC)
Max. backplane current at 5.75 VDC	600 mA (at 5.72 VDC) At this current consumption the module is switched OFF from backplane. Occurs when module is faulty, e.g. internal short circuit.
Compatible backplane units	101-200011, 101-200022, 101-200023, 101-200024, 101-200027
Head Station firmware	1.288 and higher
Protocol specifications	

Supported Protocols	DP-V0, DP- V1, DP-V2, FDL, MPI, FMS, PROFIsafe, PROFIdrive and any other FDL based protocol
Address	No bus address required
Transmission speed	9.6 kbps ... 12 Mbps (including 45.45 kbps)
Transmission speed detection time	Auto detect (< 10 s detection and 50 s baudrate switchover time)
Total delay ring structure	$T_{SLOT} \geq \text{Max}_{TSDR} + ((FO_{length} \times FO_{delay}) + (N_{FO-modules} \times N_{delay})) \times 2$ FO_{length} = Total length of fiber optic cable in the ring in km FO_{delay} = Delay of fiber optic cable per km in bit times (see table) $N_{FO-modules}$ = Number of fiber optic modules in the ring N_{delay} = Delay of one fiber optic module (see table)

The delay time is multiplied by 2 for a request and response message.

Baudrate	Max _{TSDR} [Tbit]	FO _{delay} [Tbit/km]	N _{delay} [Tbit]
12 Mbps	800	60	47
6 Mbps	450	30	25
3 Mbps	250	15	14.5
1.5 Mbps	150	7.5	9
500 kbps	100	2.5	5
187.5 kbps	60	0.94	4.5
93.75 kbps	60	0.47	4.5
45.45 kbps	400	0.23	4.5
19.2 kbps	60	0.1	4
9.6 kbps	60	0.05	4

Note

$$FO_{delay} = (FO_{cable_length} / FO_{cable\ latency}) / Bit_{time}$$

example FO_{delay}, 1km, 1.5Mbps:

$$(1000\text{ m} / 200\ \mu\text{sec/m}) / 0.666\ \mu\text{sec} = 7.5\ \text{Tbit/km}$$

Example 1: 1.5 Mbps, 5 km FO cable (total ring length), 6 FO ring modules

$$T_{SLOT} \geq \text{Max}_{TSDR} + ((FO_{length} \times FO_{delay}) + (N_{FO-modules} \times N_{delay})) \times 2$$

$$T_{SLOT} \geq 150 + ((5 \times 7.5) + (6 \times 9)) \times 2 \geq 333\ \text{bit times}$$

Example 2: 6 Mbps, 25 km FO cable (total ring length), 10 FO ring modules

$$T_{SLOT} \geq \text{Max}_{TSDR} + ((FO_{length} \times FO_{delay}) + (N_{FO-modules} \times N_{delay})) \times 2$$

$$T_{SLOT} \geq 450 + ((25 \times 30) + (10 \times 25)) \times 2 \geq 2450\ \text{bit times}$$

Jitter per message frame	0.0625 Tbit at 9.6 Kbps - 3 Mbps 0.125 Tbit at 6 Mbps 0.25 Tbit at 12 Mbps
--------------------------	--

Deviation	2 Tbit times for received messages is allowed and is corrected to nominal speed when transmitted (<i>over the complete message</i>)
-----------	---

Fiber optic specifications

Fiber Optic wavelength	Multimode 1310 nm
Cable type	Multimode Fiber G62.5 (50) / 125 μm (OM1)

Cable length	Max. 5 km (baudrate independent)
Optical budget	13dB
Optical Loss	2dB per km
Connectors	4 x ST/BFOC (2 channels)
Topologies	Ring, point-to-point (direct, hub, split, star)
Cascading depth	No limit, only busparameter limitation of the master

Dipswitches

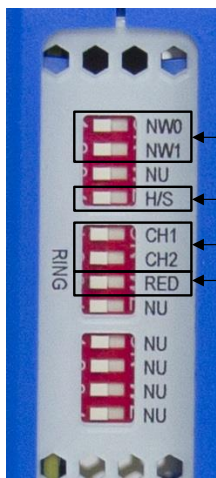

Network selection

Network 1: NW0 = Left, NW1 = Left
 Network 2: NW0 = Right, NW1 = Left
 Network 3: NW0 = Left, NW1 = Right
 Network 4: NW0 = Right, NW1 = Right

Use dipswitches or server settings (Left = DIP, Right = SERVER)

Enable or disable channel 1 or 2 (Left = ON, Right = OFF)

Ring Redundancy or Line (Left = RING, Right = LINE)

NU = not used

LEDs

	OFF	Blinking	ON
RDY	Module has NOT been powered / initialized yet.	Head Station is initializing or updating the module.	Module has been initialized and is operational
RX1 / RX2	NO signal, or NO valid telegrams detected on this channel, or channel is off.	1 or more devices are communicating on this channel.	A fiber optic cable is connected and link is established correctly
LV1 / LV2	Signal quality is good, or channel is off.	Not possible	Low signal, received messages can still be decoded
ER1 / ER2	No errors, or channel is off.	Not possible	No baudrate detected or no connection/signal

Standard and approvals

CE	EMC Directive 2014/30/EU, class B Digital Device RoHs Directive 2011/65/EU
FCC	47 CFR 15, Unintentional Radiator, class B Digital Device.
UL	Report reference: E468970 Standards for safety: UL 508 - Industrial Control Equipment CSA C22.2 No. 142-M1987 - Industrial Control Equipment

26 Technical Data - Fiber Optic Ring SM1 (101-201531)

Dimensions and weight	
Dimensions L x W x H	146 x 25 x 101 mm (including backplane)
Weight	121 g (excluding plug-able fiber optic connector and packing material)
Mounting DIN-rail type	35mm x 7,5mm (EN 50022, BS 5584, DIN 46277-3)
Ambient conditions	
Operating temperature range	0° to +60° Celsius (for mounting position see manual) 32° to +140° Fahrenheit
Isolation class	IP 20 (IEC/EN 60529, DIN 40050)
Backplane	
PROFIBUS networks	4 (set by dipo switches or web server)
Modules	Max. 10 (positioned in the first 10 slots)
Power supply	Provided through the backplane
Typical backplane current at 5.75 VDC	400 mA (at 5.72 VDC)
Max. backplane current at 5.75 VDC	600 mA (at 5.72 VDC) At this current consumption the module is switched OFF from backplane. Occurs when module is faulty, e.g. internal short circuit.
Compatible backplane units	101-200011, 101-200022, 101-200023, 101-200024, 101-200027

Protocol specifications

Supported Protocols	DP-V0, DP- V1, DP-V2, FDL, MPI, FMS, PROFIsafe, PROFIdrive and any other FDL based protocol
Address	No bus address required
Transmission speed	9.6 kbps ... 12 Mbps (including 45.45 kbps)
Transmission speed detection time	Auto detect (< 10 s detection and 50 s baudrate switchover time)

Total delay ring structure	$T_{\text{SLOT}} \geq \text{Max}_{\text{TSDR}} + ((\text{FO}_{\text{length}} \times \text{FO}_{\text{delay}}) + (\text{N}_{\text{FO-modules}} \times \text{N}_{\text{delay}})) \times 2$ <p> $\text{FO}_{\text{length}}$ = Total length of fiber optic cable in the ring in km FO_{delay} = Delay of fiber optic cable per km in bit times (see table) $\text{N}_{\text{FO-modules}}$ = Number of fiber optic modules in the ring N_{delay} = Delay of one fiber optic module (see table) </p>
----------------------------	---

The delay time is multiplied by 2 for a request and response message.

Baudrate	Max _{TSDR} [Tbit]	FO _{delay} [Tbit/km]	N _{delay} [Tbit]
12 Mbps	800	60	47
6 Mbps	450	30	25
3 Mbps	250	15	14.5
1.5 Mbps	150	7.5	9
500 kbps	100	2.5	5
187.5 kbps	60	0.94	4.5
93.75 kbps	60	0.47	4.5
45.45 kbps	400	0.23	4.5
19.2 kbps	60	0.1	4
9.6 kbps	60	0.05	4

Note

$$\text{FO}_{\text{delay}} = (\text{FO}_{\text{cable_length}} / \text{FO}_{\text{cable latency}}) / \text{Bit}_{\text{time}}$$

example FO_{delay} , 1km, 1.5Mbps:

$$(1000 \text{ m} / 200 \text{ } \mu\text{sec/m}) / 0.666 \text{ } \mu\text{sec} = 7.5 \text{ Tbit/km}$$

Example 1: 1.5 Mbps, 5 km FO cable (total ring length), 6 FO ring modules

$$T_{\text{SLOT}} \geq \text{Max}_{\text{TSDR}} + ((\text{FO}_{\text{length}} \times \text{FO}_{\text{delay}}) + (\text{N}_{\text{FO-modules}} \times \text{N}_{\text{delay}})) \times 2$$

$$T_{\text{SLOT}} \geq 150 + ((5 \times 7.5) + (6 \times 9)) \times 2 \geq 333 \text{ bit times}$$

Example 2: 6 Mbps, 25 km FO cable (total ring length), 10 FO ring modules

$$T_{\text{SLOT}} \geq \text{Max}_{\text{TSDR}} + ((\text{FO}_{\text{length}} \times \text{FO}_{\text{delay}}) + (\text{N}_{\text{FO-modules}} \times \text{N}_{\text{delay}})) \times 2$$

$$T_{\text{SLOT}} \geq 450 + ((25 \times 30) + (10 \times 25)) \times 2 \geq 2450 \text{ bit times}$$

Jitter per message frame

0.0625 Tbit at 9.6 Kbps - 3 Mbps

0.125 Tbit at 6 Mbps

0.25 Tbit at 12 Mbps

Deviation

2 Tbit times for received messages is allowed and is corrected to nominal speed when transmitted (*over the complete message*)







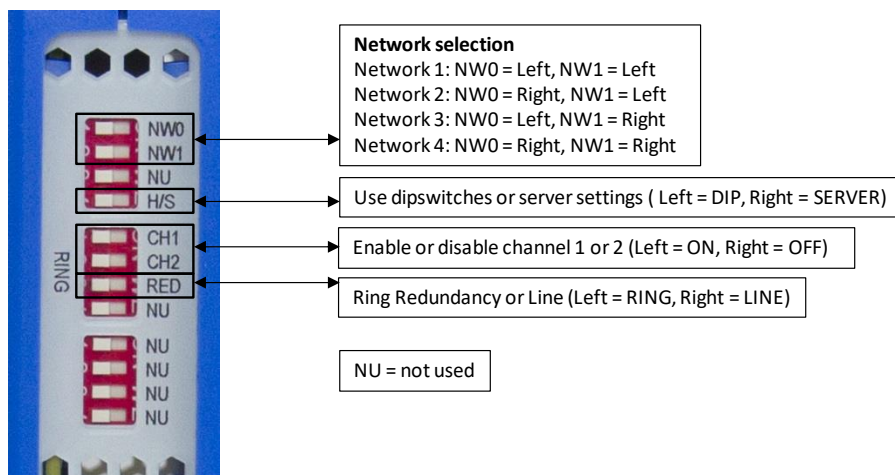



Fiber optic specifications

Fiber Optic wavelength	Single mode 1310 nm
Cable type	Fiber 9 / 125 μm (OS1)
Cable length	Max. 30 km (baudrate independent)
Optical budget	17dB
Optical Loss	0,4dB per km
Connectors	4 x ST/BFOC (2 channels)
Topologies	Ring, point-to-point (direct, hub, split, star)
Cascading depth	No limit, only busparameter limitation of the master

Dipswitches



LEDs

	OFF	Blinking	ON
RDY	 Module has NOT been powered / initialized yet.	 Head Station is initializing or updating the module.	 Module has been initialized and is operational
RX1 / RX2	 NO signal, or NO valid telegrams detected on this channel, or channel is off.	 1 or more devices are communicating on this channel.	 A fiber optic cable is connected and link is established correctly
LV1 / LV2	 Signal quality is good, or channel is off.	Not possible	 Low signal, received messages can still be decoded
ER1 / ER2	 No errors, or channel is off.	Not possible	 No baudrate detected or no connection/signal

Standard and approvals

CE	EMC Directive 2014/30/EU, class B Digital Device RoHs Directive 2011/65/EU
FCC	47 CFR 15, Unintentional Radiator, class B Digital Device.
UL	Report reference: E468970 Standards for safety: UL 508 - Industrial Control Equipment CSA C22.2 No. 142-M1987 - Industrial Control Equipment

Others

Head Station firmware	1.288 and higher
-----------------------	------------------

27 Technical Data - Fiber Optic Ring XM1 (101-201532)

Dimensions and weight	
Dimensions L x W x H	146 x 25 x 101 mm (including backplane)
Weight	121 g (excluding plug-able fiber optic connector and packing material)
Mounting DIN-rail type	35mm x 7,5mm (EN 50022, BS 5584, DIN 46277-3)
Ambient conditions	
Operating temperature range	0° to +60° Celsius (for mounting position see manual) 32° to +140° Fahrenheit
Isolation class	IP 20 (IEC/EN 60529, DIN 40050)
Backplane	
PROFIBUS networks	4 (set by dipswitches or web server)
Modules	Max. 10 (positioned in the first 10 slots)
Power supply	Provided through the backplane
Typical backplane current at 5.75 VDC	400 mA (at 5.72 VDC)
Max. backplane current at 5.75 VDC	600 mA (at 5.72 VDC) At this current consumption the module is switched OFF from backplane. Occurs when module is faulty, e.g. internal short circuit.
Compatible backplane units	101-200011, 101-200022, 101-200023, 101-200024, 101-200027
Head Station firmware	At least version 1.288
Protocol specifications	
Supported Protocols	DP-V0, DP- V1, DP-V2, FDL, MPI, FMS, PROFIsafe, PROFIdrive and any other FDL based protocol
Address	No bus address required
Transmission speed	9.6 kbps ... 12 Mbps (including 45.45 kbps)
Transmission speed detection time	Auto detect (< 10 s detection and 50 s baudrate switchover time)
Total delay ring structure	$T_{\text{SLOT}} \geq \text{Max}_{\text{TSDR}} + ((\text{FO}_{\text{length}} \times \text{FO}_{\text{delay}}) + (\text{N}_{\text{FO-modules}} \times \text{N}_{\text{delay}})) \times 2$ <p> $\text{FO}_{\text{length}}$ = Total length of fiber optic cable in the ring in km FO_{delay} = Delay of fiber optic cable per km in bit times (see table) $\text{N}_{\text{FO-modules}}$ = Number of fiber optic modules in the ring N_{delay} = Delay of one fiber optic module (see table) </p>

The delay time is multiplied by 2 for a request and response message.

Baudrate	Max _{TSDR} [Tbit]	FO _{delay} [Tbit/km]	N _{delay} [Tbit]
12 Mbps	800	60	47
6 Mbps	450	30	25
3 Mbps	250	15	14.5
1.5 Mbps	150	7.5	9
500 kbps	100	2.5	5
187.5 kbps	60	0.94	4.5
93.75 kbps	60	0.47	4.5
45.45 kbps	400	0.23	4.5
19.2 kbps	60	0.1	4
9.6 kbps	60	0.05	4

Note

$$FO_{\text{delay}} = (FO_{\text{cable_length}} / FO_{\text{cable latency}}) / \text{Bit}_{\text{time}}$$

example FO_{delay}, 1km, 1.5Mbps:

$$(1000 \text{ m} / 200 \mu\text{sec/m}) / 0.666 \mu\text{sec} = 7.5 \text{ Tbit/km}$$

Example 1: 1.5 Mbps, 5 km FO cable (total ring length), 6 FO ring modules

$$T_{\text{SLOT}} \geq \text{Max}_{\text{TSDR}} + ((FO_{\text{length}} \times FO_{\text{delay}}) + (N_{\text{FO-modules}} \times N_{\text{delay}})) \times 2$$

$$T_{\text{SLOT}} \geq 150 + ((5 \times 7.5) + (6 \times 9)) \times 2 \geq 333 \text{ bit times}$$

Example 2: 6 Mbps, 25 km FO cable (total ring length), 10 FO ring modules

$$T_{\text{SLOT}} \geq \text{Max}_{\text{TSDR}} + ((FO_{\text{length}} \times FO_{\text{delay}}) + (N_{\text{FO-modules}} \times N_{\text{delay}})) \times 2$$

$$T_{\text{SLOT}} \geq 450 + ((25 \times 30) + (10 \times 25)) \times 2 \geq 2450 \text{ bit times}$$

Jitter per message frame

Deviation

0.0625 Tbit at 9.6 Kbps - 3 Mbps

0.125 Tbit at 6 Mbps

0.25 Tbit at 12 Mbps

2 Tbit times for received messages is allowed and is corrected to nominal speed when transmitted (*over the complete message*)

Fiber optic specifications

Fiber Optic wavelength	Multimode and Singlemode 1310 nm
Cable type	Multimode Fiber G62.5 (50) / 125 μm (OM1)
Cable length	Multimode Max. 5 km (baudrate independent) Single mode Max. 30 km (baudrate independent)
Optical budget	Multimode 13 dB and Singlemode 17 dB
Optical Loss	Multimode 2 dB per km and Single mode 0.4 dB per km
Connectors	4 x ST/BFOC (2 channels)
Topologies	Ring, point-to-point (direct, hub, split, star)
Cascading depth	No limit, only busparameter limitation of the master

Dipswitches

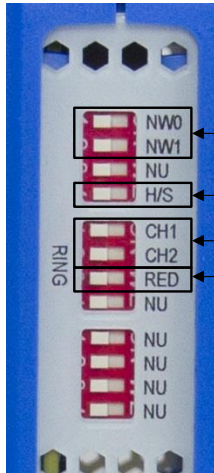

Network selection
 Network 1: NW0 = Left, NW1 = Left
 Network 2: NW0 = Right, NW1 = Left
 Network 3: NW0 = Left, NW1 = Right
 Network 4: NW0 = Right, NW1 = Right

Use dipswitches or server settings (Left = DIP, Right = SERVER)

Enable or disable channel 1 or 2 (Left = ON, Right = OFF)

Ring Redundancy or Line (Left = RING, Right = LINE)

NU = not used

LEDs

	OFF	Blinking	ON
RDY	Module has NOT been powered / initialized yet.	Head Station is initializing or updating the module.	Module has been initialized and is operational
RX1 / RX2	NO signal, or NO valid telegrams detected on this channel, or channel is off.	1 or more devices are communicating on this channel.	A fiber optic cable is connected and link is established correctly
LV1 / LV2	Signal quality is good, or channel is off.	Not possible	Low signal, received messages can still be decoded
ER1 / ER2	No errors, or channel is off.	Not possible	No baudrate detected or no connection/signal

Standard and approvals

CE	EMC Directive 2014/30/EU, class B Digital Device RoHs Directive 2011/65/EU
FCC	47 CFR 15, Unintentional Radiator, class B Digital Device.
UL	

Report reference: E468970

Standards for safety: UL 508 - Industrial Control Equipment CSA
C22.2 No. 142-M1987 - Industrial Control Equipment

28 Technical Data - SALT Repeater (101-201710)

Technical Data - Alternative Cable Repeater (101-201710)	
Backplane	
PROFIBUS networks Modules Power supply Current consumption Compatible backplane units	4 (set by dipswitches or web server) 10 (positioned in the first 10 slots) Provided through the backplane 400 mA (600 mA max) At this current consumption the module is switched OFF from backplane. Occurs when module is faulty, e.g. internal short circuit. 101-200011, 101-200012, 101-200023, 101-200024, 101-200027
Protocol specifications	
Supported Protocols	DP-V0, DP- V1, DP-V2, FDL, MPI, FMS, PROFIsafe, PROFIdrive and any other FDL based protocol
Address	NO bus address required
Transmission speed	9.6 kbps .. 12 Mbps (including 45.45 kbps)
Transmission speed detection	Auto detect (< 10 s detection and 50 s lost time)
Data delay time (normal mode)	2.0 TBit at 9.6 kbps .. 3 Mbps 2.75 TBit at 6 Mbps 3.75 TBit at 12 Mbps
Data delay time (redundant mode)	12.0 TBit at 9.6 kbps .. 3 Mbps 12.75 TBit at 6 Mbps 13.75 TBit at 12 Mbps
Delay time jitter	Max. ¼ TBit
Oscilloscope specifications	
Frequency	192 MS/s
Resolution	50 mV
Differential range	-6.436 .. 6.436 V
Cable specifications	
Cable lengths	Depends on the cable type used
Wire diameter (for the screw terminals)	< 2.5 mm ²
Wire type	Stranded or solid core
Number of devices	Maximum 31 devices per channel (busloads)

Technical Data - Alternative Cable Repeater (101-201710)

Cascading depth	No limit, only busparameter limitation of the master
Redundancy	Yes, maximum 10 cables activated by switch

Termination

Termination range (MIDDLE)	94 .. 940 Ohm (DC)	57 .. 1500 Ohm (AC)
Idle voltage range (PULL-UP)	0 .. 5 V	

Dipswitches

NW0 NW1
 LEFT LEFT
 RIGHT LEFT
 LEFT RIGHT
 RIGHT RIGHT

RED
 LEFT / RIGHT

H/S
 LEFT / RIGHT

PROFIBUS Network

- 1
- 2
- 3
- 4

Redundancy
 OFF / ON

Settings
 Hardware / Software

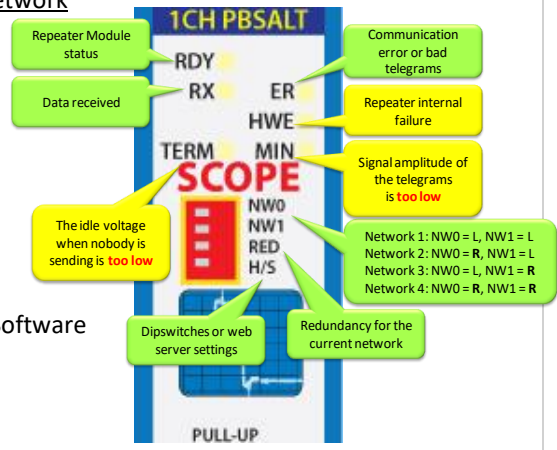

PROFIBUS connectors

CH1
 A, B
 SH
 I

Screw terminals
 Green wire, Red wire
 Direct grounding
 Indirect grounding

LEDs

RDY
 RX
 HW
 ER
 MIN
 TERM

Module is ready for operation (ON)
 Receiving telegrams (blinking)
 Internal repeater error (contact PROCENTEC)
 No or bad telegrams detected
 Signal amplitude of the telegrams too low (< 2.5 V)
 Idle voltage too low (<0.5 V .. >1.7 V)

Alarm values can be changed through the web server.

Others

Head Station firmware
 Operating temperature
 Weight

At least version 1.264
 0 .. 60 °C
 120 g

29 Technical Data - PA Module (101-201610)

Technical Data - PA Module (101-201610)	
Dimensions and weight	
Dimensions L x W x H	133 x 25 x 105 mm (including backplane, per module)
Weight	133 g (excluding plug-able connectors, backplane and packing material)
Mounting DIN-rail type	35mm x 7,5mm (EN 50022, BS 5584, DIN 46277-3)
Ambient conditions	
Ambient operating temperature range	-20° ... +60° Celsius (for mounting position see manual) -4° ... 158° Fahrenheit
Isolating class	IP 20 (IEC/EN 60529, DIN 40050)
Backplane	
PROFIBUS networks	4 (set by dipo switches or web server)
Module position Modules	First 10 slots Link mode: max. 9 PA modules and 1 DP repeater module Coupler mode: max. 9 PA modules and 1 DP repeater module Monitoring mode: max. 4 PA modules (4 backplane networks)
Power supply for the module Typical backplane current Max. backplane current	Provided through the backplane 350 mA (at 5.72 VDC) 550 mA (at 5.72 VDC) At this current consumption the module is switched OFF from backplane. Occurs when module is faulty, e.g. internal short circuit.
Compatible backplane units	101-200011, 101-200022, 101-200023, 101-200024, 101-200027
PROFIBUS PA power specifications	
Trunk voltage Trunk current Current consumption	10 to 27 VDC customizable PA trunk voltage (Non-Ex) 500 mA 10 mA (in all modes)
PROFIBUS PA cable specifications	
Cable length Wire diameter Wire type Termination	Max. 1900 m cable length (PROFIBUS PA specifications) < 2.5 mm ² Stranded or solid core ON when power supplied on PA power connector

Technical Data - PA Module (101-201610)

PROFIBUS DP protocol specifications

Supported Protocols	DP-V0, DP- V1, DP-V2, FDL, MPI, FMS, PROFIsafe, PROFIdrive and any other FDL based protocol
Address	No bus address required
Transmission speed	9.6 kbps to 12 Mbps (including 45.45 kbps)
Transmission speed detection	Auto detect (< 10 s detection and 50 s baudrate switchover time)
PROFIBUS busparameters	No adjustments required in Link mode

PROFIBUS PA protocol specifications

Address	Coupler mode: no address required Link mode: master on PA bus address 1 (fixed)
Number of devices	32 (PROFIBUS PA specifications)
Baudrate PA bus	31.25 kbps

Oscilloscope specifications

AC PA voltage	4 MS/s, resolution 7.5 mV, range -0.95 to 0.95 V
DC PA voltage	1 kS/s, resolution 75 mV, range -38 to +38 V
DC PA current	1 kS/s, resolution 1 mA, range 0 to 1024 mA

Connector lay-out

<u>2x PROFIBUS PA</u>	<u>Plug-able screw connector, connectors 1 to 1, pitch 5.08 mm</u> Pin PA- : 0 V Pin PA+ : 10 to 27 VDC Pin SH : Shield Pin I : Indirect Shield
<u>PA Power</u>	<u>Plug-able screw connector, pitch 5,08 mm</u> Pin - : 0 V Pin + : 10 to 27 VDC Pin SH: Shield <i>Pin SH is connected internally to the DIN-rail with spring-loaded contact.</i> <i>Pin I is connected internally with 10nF/1MOhm to shield.</i>

Technical Data - PA Module (101-201610)

Dipswitches

NW0 NW1
 LEFT LEFT
 RIGHT LEFT
 LEFT RIGHT
 RIGHT RIGHT

LNK
 LEFT / RIGHT

H/S
 LEFT / RIGHT

PROFIBUS Network

- 1
- 2
- 3
- 4

Link mode
 OFF / ON

Settings
 Hardware / Software

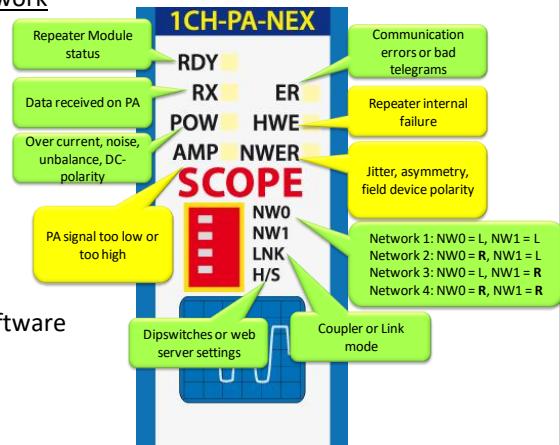

LEDs

RDY : Ready
 RX : Receiving data
 HWE : Hardware error
 ER : Error
 AMP : Amplitude error
 POW : Power error
 NWER : Network error

Module is ready for operation (ON)
 Receiving PA telegrams (blinking)
 Internal hardware error (contact PROCENTEC)
 No or bad telegrams on PA detected
 PA signal too low or too high
 Over current, noise, unbalance, DC-polarity
 Jitter, asymmetry, field device polarity

Alarm values can be changed through the web server.

Standard and approvals

CE

EMC Directive 2014/30/EU, class B Digital Device
 RoHs Directive 2011/65/EU

FCC

47 CFR 15, Unintentional Radiator, class B Digital Device.

UL

Report reference: E468970
 Standards for safety: UL 508 - Industrial Control Equipment, CSA C22.2 No. 142-M1987 - Industrial Control Equipment

Others

Head Station firmware
 MTBF

At least version 1.279
 1165020 hours, at 30° Celsius, IEC TR 62380

30 Technical Data - 4 CH Relay Module (101-210210)

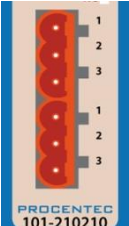
Technical Data - 4 Channel Relay Module (101-210210)	
Backplane	
Controllers	Web server, PROFINET IO device, PROFIBUS DP slave
Modules	32 (all slots)
Power supply	Provided through the backplane
Typical backplane current	225 mA (at 5.72 VDC)
Max. backplane current	500 mA (at 5.72 VDC) At this current consumption the module is switched OFF from backplane. Occurs when module is faulty, e.g. internal short circuit.
Compatible backplane units	101-200011, 101-200012, 101-200023, 101-200024, 101-200027
Relays	
Relays	4 (2 on the front, and 2 on the bottom)
Current	5 A per relay
Voltage	230 VAC
Resistance	300 mOhm (including connectors)
Toggles	100000 (at 5A - 230 VAC)
Connectors	
Pins	1 = No (normally open) 2 = Common 3 = Nc (normally closed)
Wire diameter (for the screw terminals)	< 2.5 mm ²
Wire type	Stranded or solid core
	
Others	
Head Station firmware	V1.260 and later
Dimensions	140 x 110 x 25 mm
Operating temperature	0 .. 60 °C
Weight	125 g

31 Technical Data - 8 CH D-out Module (101-210110)

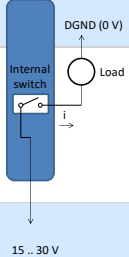
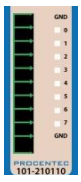
Technical Data - 8 Channel Digital Out Module (101-210110)	
Backplane	
<p>Controllers</p> <p>Modules</p> <p>Power supply module electronics</p> <p>Power supply digital outputs</p> <p>Typical backplane current consumption</p> <p>Max. backplane current consumption</p> <p>Compatible backplane units</p>	<p>Web server, PROFINET IO device, PROFIBUS DP slave</p> <p>32 (all slots)</p> <p>Provided through the backplane</p> <p>Provided through an additional 3-pin connector</p> <p>400 mA (at 5.72 VDC)</p> <p>600 mA (at 5.72 VDC) At this current consumption the module is switched OFF from backplane. Occurs when module is faulty, e.g. internal short circuit.</p> <p>101-200011, 101-200012, 101-200023, 101-200024, 101-200027</p>
Digital Outputs	
<p>Outputs</p> <p>Current</p> <p>Voltage range</p> <p>Losses</p>	<p>8 Digital Outs on 1 connector</p> <p>0.5 A per Digital Out (direct current)</p> <p>15..30 VDC (depends on provided voltage)</p> <p>0.211 Ohm loss per Digital Out</p>
	
Power Connector	
<p>Pins power connector</p> <p>Wire diameter (for the screw terminals)</p> <p>Wire type</p>	<p>1 = -, 2 = +, 3 = SH</p> <p>< 2.5 mm²</p> <p>Stranded or solid core</p>
Digital Output Connector	
<p>Pins DO connector</p> <p>Wire diameter (for the screw terminals)</p> <p>Wire type</p>	<p>1 = GND, 2..9 = DO0..DO7, 10 = GND</p> <p>< 1.5 mm²</p> <p>Stranded or solid core</p>
	
Others	
<p>Head Station firmware</p> <p>Dimensions</p> <p>Operating temperature</p> <p>Weight</p>	<p>V1.260 and later</p> <p>140 x 110 x 25 mm</p> <p>0 .. 60 °C</p> <p>105 g</p>

32 Technical Data - 8 CH D-in Module (101-210010)

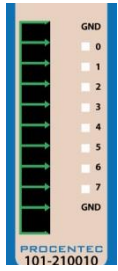
Technical Data - 8 Channel Digital In Module (101-210010)	
Backplane	
Controllers	PROFINET IO device, PROFIBUS DP slave
Modules	32 (all slots)
Power supply	Provided through the backplane
Current consumption	Typ. 169 mA (500 mA max, At this current consumption the module is switched OFF from backplane. Occurs when module is faulty, e.g. internal short circuit.)
Compatible backplane units	101-200011, 101-200012, 101-200023, 101-200024, 101-200027
Digital Inputs	
Inputs	8 digital inputs on 1 connector
Power per input	240 mW at 24 V
Signal Voltage for '1'	3 .. 32 VDC
Input detection frequency	Max. 3 ms
Digital Input Connector	
Pins of Digital Inputs connector	1 = GND, 2..9 = DI0..DI7, 10 = GND1
Wire diameter (for the screw terminals)	< 1.5 mm ²
Wire type	Stranded or solid core
	
Others	
Head Station firmware	V1.271 and later
Dimensions (L x W x H)	140 x 110 x 25 mm
Operating temperature	0 .. 60 °C
Weight	100 g

33 Technical Data – RS-485-IS Barrier (101-201410)

Technical Data – RS-485-IS Barrier (101-201410)	
Backplane	
PROFIBUS networks	4 (set by dipswitches or web server)
Modules	10 (positioned in the first 10 slots)
Power supply	Provided through the backplane
Current consumption	± 450 mA (750 mA max, At this current consumption the module is switched OFF from backplane. Occurs when module is faulty, e.g. internal short circuit.
Compatible backplane units	101-200011, 101-200012, 101-200023, 101-200024, 101-200027
Protocol specifications	
Supported Protocols	DP-V0, DP- V1, DP-V2, FDL, MPI, FMS, PROFIsafe, PROFIdrive and any other FDL based protocol
Address	No bus address required
Transmission speed	9.6 kbps .. 1.5 Mbps (including 45.45 kbps)
Transmission speed detection	Auto detect (< 10 s detection and 50 s lost time)
Data delay time (normal mode)	2.0 TBit
Data delay time (redundant mode)	12.0 TBit
Delay time jitter	Max. ¼ TBit
Oscilloscope specifications	
Frequency	192 MS/s
Resolution	27 mV
Differential range	-3.49 .. 3.49 V
PROFIBUS cable specifications	
Cable lengths	1200 m at 9.6 kbps .. 93.75 kbps 1000 m at 187.5 kbps 400 m at 500 kbps 200 m at 1.5 Mbps
Number of devices	Maximum 31 devices per channel (busloads)
Required termination	DB9-IS connector with internal 200Ω only
Redundancy	Yes, maximum 10 cables activated by switch

Technical Data – RS-485-IS Barrier (101-201410)

Dipswitches

NW0	NW1
LEFT	LEFT
RIGHT	LEFT
LEFT	RIGHT
RIGHT	RIGHT

RED
LEFT / RIGHT

H/S
LEFT / RIGHT

PROFIBUS Network

- 1
- 2
- 3
- 4

Redundancy
OFF / ON

Settings
Hardware / Software

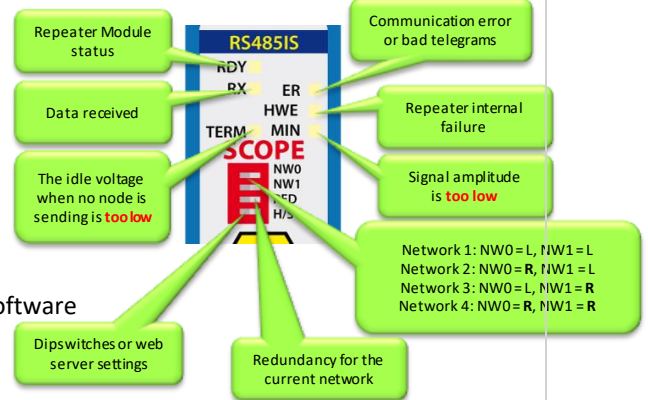

ATEX (electrical)

U _o	4.2 V
I _o	149 mA
U _i	≥ 4.2
L _i	≈ 0 μH V
C _i	Negligibly small
Output characteristic	Linear

ATEX (compliance):

 II (2) G [Ex ia Gb] IIC
 EN-IEC60079-0: 2009 / EN-IEC60079-11: 2012 / EN-IEC60079-25: 2010
 PROFIBUS International IS Installation Guidelines
 Certification number: **DEKRA 12ATEX0192**

LEDs

RDY	Module is ready for operation (ON)
RX	Receiving telegrams (blinking)
HWI	Internal repeater error (contact PROCENTEC)
ER	No or bad telegrams detected
MIN	Signal amplitude of the telegrams too low (< 1.64 V)
TERM	Idle voltage too low (<0.35 V .. >0.75 V) <i>Alarm values can be changed through the web server.</i>

Others

Head Station firmware	At least version 1.272
Operating temperature	0 .. 60 °C
Weight	150 g

34 Technical Data - PROFIBUS Slave Module PBS-001

Technical Data – PROFIBUS Slave PBS-001 (101-220210)	
Backplane	
PROFIBUS networks Modules	10 (web server), 4 (dipswitches and web server) 10 (positioned in the first 10 slots)
Power supply Current consumption	Provided through the backplane ± 390 mA typical (Max. 625 mA At this current consumption the module is switched OFF from backplane. Occurs when module is faulty, e.g. internal short circuit.
Compatible backplane units Compatible partner/gateway modules	101-200011, 101-200012, 101-200023, 101-200024, 101-200027 101-220210, 101-220110, 101-210210, 101-210110, 101-210010
PROFIBUS DP Slave Device	
Supported protocol Ident Number GSD filename	DP-V0 (certification number: Z01776) 696F PROC696F.gsd (www.procentec.com/downloads)
Bus address	1 – 99 (set by rotary switches) or 0 – 126 (set by software)
Transmission speed Transmission speed detection	9.6 kbps .. 12 Mbps (including 45.45 kbps) Auto detect
Maximum transferrable data Max. transferrable data per gateway Maximum number of gateway modules	244 bytes input and 244 bytes output 128 bytes input and 128 bytes output 9
Selectable number of I/O bytes or words per gateway	1, 2, 3, 4, 8, 12, 16, 20, 24, 28, 32, 64 bytes 48, 64 words
Consistent Gateways:	2, 3, 4, 8, 12, 16, 20, 24, 28, 32, 64 bytes 48, 64 words
Failsafe options Simulation input patterns	Outputs OFF, Outputs ON, Keep last value, Custom failsafe value ON, OFF, Blink, Up counter, Down counter, Zig Zag
RS-485 Repeater	
Bus channels Connector	1 x RS-485 DB9 (A, B, 5V, GND)
Number of devices	Maximum 31 devices per channel (busloads)
Cable lengths	1200 m at 9.6 kbps .. 93.75 kbps 1000 m at 187.5 kbps 400 m at 500 kbps

Technical Data – PROFIBUS Slave PBS-001 (101-220210)

	200 m at 1.5 Mbps 100 m at 3 Mbps .. 12 Mbps
Supported protocols	DP-V0, DP- V1, DP-V2, FDL, MPI, FMS, PROFIsafe, PROFIdrive and any other FDL based protocol
Data delay time	2.0 TBit at 9.6 kbps .. 3 Mbps 2.75 TBit at 6 Mbps 3.75 TBit at 12 Mbps
Delay time jitter	Max. ¼ TBit

Dipswitches

<u>NW0</u> <u>NW1</u>	<u>PROFIBUS Network</u>
LEFT LEFT	1
RIGHT LEFT	2
LEFT RIGHT	3
RIGHT RIGHT	4
 <u>NU</u>	 Not Used
 <u>H/S</u>	 <u>Settings</u>
LEFT / RIGHT	Hardware / Software

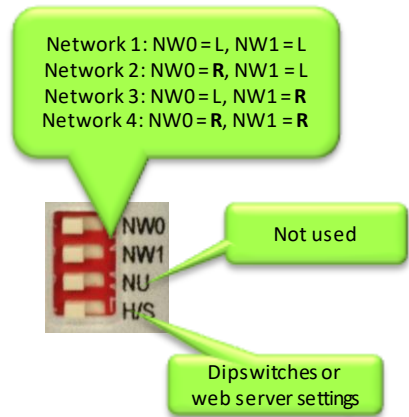

LEDs

RDY (ON)	Module is ready for operation
RDY (Flashing)	Connecting or updating
RUN (ON)	Internal firmware is OK
SF (ON)	System Failure: diagnostics or configuration mismatch
BF (ON)	Bus Failure: not in Data Exchange with master

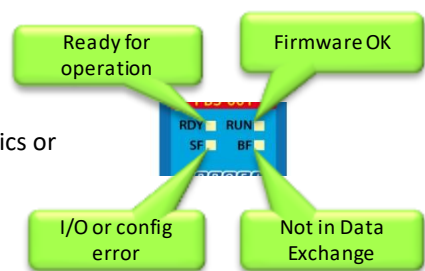

Others

Head Station firmware	At least version 1.275
Operating temperature	0 .. 60 °C
Weight	120 g

35 Technical Data - PROFINET Device PND001

Technical Data - PROFINET PND001 (101-220110)	
Backplane	
Modules	10 (positioned in the first 10 slots)
Power supply	Provided through the backplane
Current consumption	± 350 mA typical (Max. 625 mA At this current consumption the module is switched OFF from backplane. Occurs when module is faulty, e.g. internal short circuit.
Compatible backplane units	101-200011, 101-200012, 101-200023, 101-200024, 101-200027
Compatible partner/gateway modules	101-220210, 101-220110, 101-210210, 101-210110, 101-210010
PROFINET specifications	
PROFINET conformance class	B
Supported protocols	RT_CLASS_1, RTA, UDP, DCP, ARP, LLDP, SNMP (MIB II)
Switch propagation time	To be defined
Cycle times	1 ms - 1..128 input or output bytes 2 ms - 129..256 input or output bytes 4 ms - 257..512 input or output bytes 8 ms - 513..1024 input or output bytes
PROFINET IO cyclic process image	1024 input bytes, provider (IOPS) and consumer (IOCS) data qualifiers bytes included. <ul style="list-style-type: none"> • PND-001 module 4 bytes IOPS • Each input module 1 byte IOPS • Each output module 1 byte IOCS 1024 output bytes, provider (IOPS) and consumer (IOCS) data qualifiers bytes included. <ul style="list-style-type: none"> • PND-001 module 4 bytes IOCS • Each output module 1 byte IOPS • Each input module 1 byte IOCS
Transferrable bytes to proxies (inputs and outputs)	1, 2, 3, 4, 8, 12, 16, 20, 24, 28, 32, 64, 96, 128, 160, 192, 204
PROFINET cable and connector specifications	
Technology standards	100BaseTX, 10BaseT
Transmission speed detection	Auto detect, Auto cross-over, Auto polarity
Cable length	Max. 100 m
Connectors	RJ-45 <ul style="list-style-type: none"> • 90 Degree connector for port 1 is not recommended. • Shielded connectors are recommended.

Technical Data - PROFINET PND001 (101-220110)

PROFINET Device Name

Rotary switch (the use of setting position 1..9 overrides the stored device name).	0 = Stored device name (set by software - DCP protocol) 1 = "ComBricks-1" 9 = "ComBricks-9"
Maximum device name length	63 characters separated by (.) or (-) and a total length of max 240 characters

LEDs

RDY (OFF)	Module is not powered or module is faulty.
RDY (blinking at 0.3Hz)	Module is receiving new firmware from the Head Station. Do not remove module or power down the Head Station.
RDY (blinking at 1Hz)	Module is communicating with the Head Station.
RDY (ON)	The communication with the Head Station is established.
RUN (ON)	Application is running
SF (ON)	PROFINET configuration mismatch or system error
BF (OFF)	Device is in PROFINET Data Exchange.
BF (blinking at 0.5 Hz)	No Data Exchange, but physical link established.
BF (ON)	No physical link.

Certification, Approvals and Identification

Approvals	PNO PROFINET certificate (GSDML 2.25) CE Emission acc. to EN 55022 (2006) + A1 (2007) class A CE Immunity acc. to EN 55024 (1998) + A1 (2001) + A2 (2003) level 10V/m 10Vrms FCC Emission 47 CFR 15 class A
PROFINET certification number	ZZ10500
GSD filename	GSDML-V2.25-PROCENTEC-ComBricks PND_001-20120831.xml
GSD bitmap filename	GSDML-4000-0001-PND001.bmp
Manufacturer / Product Ident Number	0x4000 hex - 0x0001 hex

Others

Head Station firmware	Version 1.264 or higher
Operating temperature	0 .. 60 °C
Weight	111 g

36 Technical Data - 6A Power Module T1 (101-230010)

Technical Data - 6A Power Module Type 1 (101-230010)	
Dimensions and weight	
Dimensions L x W x H	133 x 25 x 103 mm (including backplane per module, excluding plug-able connectors)
Weight	120 g (excluding plug-able connectors, backplane and packing material)
Mounting DIN-rail type	35mm x 7,5mm (EN 50022, BS 5584, DIN 46277-3)
Ambient conditions	
Ambient operating temperature range	-20° ... +60° Celsius (for mounting position see manual) -4° ... 158° Fahrenheit
Isolating class	IP 20 (IEC/EN 60529, DIN 40050)
Power supply	
Power supply operating voltage range	12 to 24 VDC (tolerance range 6 to 32 VDC)
Typical Current consumption	60 mA at 5.72 VDC (backplane powered)
Power dissipation	Max. 0.34 W at 5.72 (backplane powered)
Reverse polarity protection	Yes
Redundant power supply	Yes (with second PWR-6A module)
Wire diameter	< 2.5 mm ²
	<p><u>Installation notes:</u> The device shall be supplied from an isolating transformer having a secondary Listed fuse rated either:</p> <ul style="list-style-type: none"> • Maximum 5 amps for voltages 12 to 20 V, or • Maximum 4 amps for voltages 21 to 24 V, <p>or is supplied by a Class 2 power supply, or equivalent.</p>
Backplane	
Module position	32 (all slots)
Current available on backplane	6A (including own current consumption typically 130 mA)
Compatible backplane units	101-200011, 101-200022, 101-200023, 101-200024, 101-200027

Technical Data - 6A Power Module Type 1 (101-230010)

Installation notes

When using the Power Module, remove power from the Head Station.

If power redundancy is required, use two Power Modules.

When moving the Power Module to a different slot: remove power before taking out the module.

Connector Lay-out

Power supply	Plug-able screw connector, pitch 5,08 mm Pin 1: - (0 V) Pin 2: + (24 VDC) Pin 3: SH (Shield) SH connected internally to DIN-rail with spring-loaded contact.
--------------	--

LEDs

ERR ON ERR + RUN OFF	Input voltage too low, or maximum current No power supply connected
-------------------------	--

Others

Head Station firmware MTBF	V1.265 and later 3082529 hours, at 30° Celsius, IEC TR 62380
-------------------------------	---

Standard and approvals

CE	EMC Directive 2014/30/EU, class A Digital Device RoHs Directive 2011/65/EU
FCC	47 CFR 15, Unintentional Radiator, class A Digital Device.
UL	Report reference: E468970 Standards for safety: UL 508 - Industrial Control Equipment CSA C22.2 No. 142-M1987 - Industrial Control Equipment

37 Frequently asked questions / FAQ

General

Are the Kits in the product list really required?

NO, the Kits are just an easy step into the ComBricks world, because they contain all required components. You can also order all items separately; Head Station, repeater modules, I/O modules, etc. Kits are also cheaper than separate items.

Backplane

How many modules can I insert in the backplane?

ComBricks can handle 32 modules, but high speed modules can only be inserted in the first 10 sockets (repeater and fiber optic modules). If you only have 5 high speed modules, the rest of the sockets can be completed with regular modules (I/O modules).

What is the "Backplane Network"?

These are the 4 internal networks on the backplane that repeater modules utilize to transfer PROFIBUS messages transparently to other inserted repeater modules who are locked to the same network number. Each network can have its own masters, slaves and baudrate. They are completely isolated.

http://www.youtube.com/watch?v=P3_gSC1pJO4

When I buy a module, is a backplane socket provided?

YES, with every module a backplane socket is provided. If you require more sockets because of spare parts, an additional set can be purchased.

Installation

What is the default IP address after purchase or reset?

The default IP address is; **192.168.1.254**. This can be customized through the web server of the Head Station or the ComBricks Discovery Tool.

PROFIBUS PA Coupler Module

How can I make the PA Coupler Module transparent for 500 kbps?

You have to update the busparameters in the master. Keep in mind that some configuration tools cannot handle the large Tslot values.

I cannot make my PA module working. What are the steps to take?

- Head Station type 1C (for the monitoring).
- At least 1 module with a DP master (RS-485 or Fiber Optic) or CommDTM class 2 master through the Head Station.
- At least 1 PA module.
- All involved modules on the same network number.
- After changing the network number, reset the ComBricks.
- Power the PA module (check the respective LED).
- If it is a floating power supply without ground (regular adapter), it is recommended to short the "-" and GND on the power supply connector of the PA module.
- Proper termination at the other end of the PA segment.
- In some cases the PA cable should also be more than 1 meter (same as RS-485).
- Verify "your" calculation of DC current with the current consumption stated in the web server (status screen).

- Verify the PA power supply voltage.
- Correct addresses of your PA devices.
- Adjust the busparameters in the master to the specific baudrate (see paragraph 12.4.1).
- Check the master in the Live List.
- Check the devices in the Live List.
- Check the PA oscilloscope signals

ProfiTrace

Do you need a constant PC connection to monitor the network?

NO, This is a great feature for permanent monitoring. ComBricks contains a kernel and web server that works independently directly after power-up. Updates of the Live List, Statistics, Logging, Emailing, etc. are all carried out on its own initiative and can always be viewed.

Do I need to install/buy monitoring software?

NO, ComBricks is based on a web server. For the basic operation you only need a web browser. But if you are used to the ProfiTrace 2 software, you can stream data over Ethernet and keep working in your original software environment.

What is the difference between ProfiTrace OE and regular ProfiTrace?

OE stands for "Over Ethernet". It is the ProfiTrace core in ComBricks which visualizes all the information in a web server. The biggest difference is that ProfiTrace OE is permanently monitoring the installation and it does not require a constant PC connection.

Where does it save monitoring data, logs and settings?

The Head Station contains a uSD card on which all information is stored. By means of the web server or FTP the user can inspect and download the information. He can of course also take out the SD card and insert it in a PC.

What is 'live data streaming' with ProfiTrace 2?

Head Stations 1B and 1C have an integrated ProfiTrace that can be accessed with a web browser. The integrated ProfiTrace has some graphical and functional limitations compared to the powerful ProfiTrace 2 software. Live data streaming is a function within ProfiTrace that makes a connection with ComBricks over Ethernet and acts as if it works with a ProfiCore. The user can now use all the functionality of ProfiTrace 2 with the protocol data of 2 or 4 networks that ComBricks is capturing (Live List, statistics, message recording, triggering, searching, etc).

We already have repeaters installed. How can we take advantage of ComBricks without disturbing the existing network?

You can connect 1 channel of a ComBricks repeater module as a regular bus participant. Like a ProfiCore and ignoring the repeater functionality. Once a repeater channel is in contact with the cable/communication, ProfiTrace monitors telegrams.

How many files does the automatic message recording triggering save?

The automatic triggering saves 1000 files per network. Each file has its own name. When a new trigger takes place after 1000 files have already been saved, the oldest file is replaced by the new one (ring recording).

Repeater modules

Are the ComBricks repeaters suitable for PROFIsafe networks?

YES, especially in combination with the repeater redundancy makes ComBricks a perfect infrastructure component for PROFIBUS safety networks. Remote maintenance with ProfiTrace OE only makes it better.

Can ComBricks be used in MPI networks?

YES, MPI is using PROFIBUS FDL telegrams with its own user data implementation. Every ComBricks repeater and fiber optic coupler can interpret and forward MPI telegrams. Also the cabling rules are the same for MPI.

How are repeater modules powered?

All power is distributed over the backplane by the Head Station. The power to the Head Station is provided by 24V power connectors (redundant option).

How can I remotely deactivate a repeater module during operation?

Officially there is no shutdown function. What you can do is set the repeater network number by software (web server) instead of dipswitches. When you want to shut it down, change the assigned network number to a number that is not used. This will cause the repeater to be isolated from the rest.

With a Head Stations 1B (ProfiTrace for 2 networks) can I still wire 4 networks divided over 10 repeater modules?

YES, ProfiTrace OE on a 1B Head Station will monitor network 1 and 2. There is no link with the repeater modules which can be set to network 1, 2, 3 and 4.

I have changed the dipo switches on the repeater modules. How can I actualize them in the system without removing the power on the Head Station?

You can soft start the system with the nav button on the Head Station or in the Device Management menu of the web server. It is also possible to remove and insert the respective module.

When a slot contains a 1 channel repeater module can I hot swap it with a 2 channel repeater module?

YES, every time a module is inserted it is configured without looking at the past.

Is a 2 channel repeater module the same as a regular repeater?

YES and NO, Of course you have 2 RS-485 sides like a regular repeater, but there is a 3rd channel going to the backplane to link up with the other inserted repeater modules. This means a 2 channel repeater module can also be compared with a 3 channel repeater, but the 3rd channel is not RS-485. Additional to this; the RS-485 channels can also be assigned to networks. Then it cannot be compared at all with a regular repeater.

Is there an overview available how to connect the PROFIBUS cable with the repeater modules and when to switch on the on-board termination?

This image illustrates the 4 configurations that we support:

In configuration A and C the cable starts at the repeater module. In configuration B and D the repeater module is in the middle of the cable.

Only in configuration A the on-board termination should be set to ON. With the other configurations the repeater module is in the middle of the segment or the termination is activated on the DB9 plug.

38 Products and spare parts

Component	Order code	Remarks
Eco Monitoring Kit	101-200QBR	<ul style="list-style-type: none"> • Head Station type 1B • 1CH repeater • Fixed backplane unit
Standard Monitoring Kit	101-200QBS	<ul style="list-style-type: none"> • Head Station type 1B • Scope repeater • Fixed backplane unit
Advanced Monitoring Kit	101-200Q4CS	<ul style="list-style-type: none"> • Head Station type 1C • 4pcs Scope repeater • Fixed backplane unit
Fiber Optic Kit	101-200QQAFR	<ul style="list-style-type: none"> • Head Station type 1A • 1CH repeater • 2CH FO coupler • Fixed backplane unit
Fiber Optic Ring Monitoring Kit – Multimode	101-200QBMS	<ul style="list-style-type: none"> • Head Station type 1B • Scope repeater • FO Ring – MM module • Fixed backplane unit
Fiber Optic Ring Monitoring Kit – Single mode	101-200QBUS	<ul style="list-style-type: none"> • Head Station type 1B • Scope repeater • FO Ring – SM module • Fixed backplane unit
Fiber Optic Ring Monitoring Kit – Combination mode	101-200QBCS	<ul style="list-style-type: none"> • Head Station type 1B • Scope repeater • FO Ring – XM module • Fixed backplane unit
RS-485-IS Monitoring Kit	101-200QBX	<ul style="list-style-type: none"> • Head Station type 1B • RS-485-IS module • Fixed backplane unit
RS-485-IS Repeater Monitoring Kit	101-200QBXR	<ul style="list-style-type: none"> • Head Station type 1B • 1CH repeater • RS-485-IS module • Fixed backplane unit
PA Monitoring Kit	101-200QBP	<ul style="list-style-type: none"> • Head Station type 1B • PA coupler module • Fixed backplane unit

Component	Order code	Remarks
PA Coupler Monitoring Kit	101-200QBPR	<ul style="list-style-type: none"> • Head Station type 1B • 1CH repeater • PA coupler module • Fixed backplane unit
Head Station Type 1C	101-20011C	<ul style="list-style-type: none"> • ProfiTrace OE on 4 networks • 1 GB SD card • Ethernet port • Redundant power supply • Drives 32 modules • CommDTM • Backplane unit • Streaming in ProfiTrace 2 • OPC in ProfiTrace 2
Head Station Type 1B	101-20011B	<ul style="list-style-type: none"> • ProfiTrace OE on 1 network • 1 GB SD card • Ethernet port • Redundant power supply • Drives 32 modules • Backplane unit included • Streaming in ProfiTrace 2 • OPC in ProfiTrace 2
Head Station Type 1A	101-20011A	<ul style="list-style-type: none"> • Basic web server • 1 GB SD card • Ethernet port • Redundant power supply • Drives 32 modules • Backplane unit included • NO ProfiTrace OE
SCOPE Repeater	101-201210	<ul style="list-style-type: none"> • 1 RS-485 channel repeater with oscilloscope • Same specs as regular 1 channel repeater • 192 MS/s sample rate • 50 mV resolution • -6.436..6.436 V • Backplane unit included
2 Channel Repeater	101-201102	<ul style="list-style-type: none"> • 2 RS-485 channels • 12 Mbps • 31 devices per channel • Screw terminals • DB9 connector • Redundancy • Termination • Backplane unit included

Component	Order code	Remarks
1 Channel Repeater	101-201101	<ul style="list-style-type: none"> • 1 RS-485 channel • 12 Mbps • 31 devices per channel • Screw terminals • DB9 connector • Redundancy • Termination • Backplane unit included
2 Channel Fiber Optic Module	101-201510	<ul style="list-style-type: none"> • 2 fiberoptic channels • 3 km cable length • 2 x 2 ST connectors • Redundancy • Backplane unit included
Fiber Optic Ring (Multimode)	101-201530	<ul style="list-style-type: none"> • 2 fiberoptic channels • 5 km cable length • 2 x 2 ST connectors • Ring Redundancy • Backplane unit included
Fiber Optic Ring (Single mode)	101-201531	<ul style="list-style-type: none"> • 2 fiberoptic channels • 30 km cable length • 2 x 2 ST connectors • Ring Redundancy • Backplane unit included
Fiber Optic Ring (Combi mode)	101-201532	<ul style="list-style-type: none"> • 2 fiberoptic channels: one MM and one SM • 5 and 30 km cable length • 2 x 2 ST connectors • Ring Redundancy • Backplane unit included
PA Link/Coupler Module	101-201610	<ul style="list-style-type: none"> • transparent up to 1.5 mbit • trunk voltage up to 27 V • trunk current 500 mA • auto termination (in coupler mode) • Backplane unit included
SALT Repeater Module	101-201710	<ul style="list-style-type: none"> • Adjustable termination: 94..940 Ohm • Adjustable idle voltage: 0..5 V • Same specs as regular Scope Repeater • Backplane unit included

Component	Order code	Remarks
RS-485-IS Barrier Module	101-201410	<ul style="list-style-type: none"> • 1 RS-485-IS channel repeater with oscilloscope • Suitable for Zone II (2) G [Ex ia Gb] IIC • 192 MS/s sample rate • Backplane unit included
PROFINET Device Module PND-001	101-220110	<ul style="list-style-type: none"> • Couples up to 10 networks (PB/PN) • Conformance class B • RT_CLASS_1 • Backplane unit included
PROFIBUS Slave Module PBS-001	101-220210	<ul style="list-style-type: none"> • Couples up to 10 networks (PB/PN) • Remote I/O, digital and relay contacts • Auto baudrate detect • Backplane unit included
4 Channel Relay Module	101-210210	<ul style="list-style-type: none"> • 5 A - 230 VAC • Backplane unit included
8 Channel Digital Out	101-210110	<ul style="list-style-type: none"> • 0.5 A - 24 VDC • Backplane unit included
8 Channel Digital In	101-210010	<ul style="list-style-type: none"> • 3 .. 32 VDC • Backplane unit included
Power Module	101-230010	<ul style="list-style-type: none"> • Provides 6 A to the backplane • Backplane unit included
Fixed Backplane 7 Modules	101-200027	<ul style="list-style-type: none"> • Fits: 1 Head Station and 6 regular modules • Extendible with standard backplane units • Improved durability
Fixed Backplane 4 Modules	101-200024	<ul style="list-style-type: none"> • Fits: 1 Head Station and 3 regular modules • Extendible with standard backplane units • Improved durability
Fixed Backplane 3 Modules	101-200023	<ul style="list-style-type: none"> • Fits: 1 Head Station and 2 regular modules • Extendible with standard backplane units • Improved durability

Component	Order code	Remarks
Fixed Backplane 2 Modules	101-200012	<ul style="list-style-type: none"> • Fits: 1 Head Station and 1 regular module • Extendible with standard backplane units • Improved durability
Backplane Units 5-pack	101-200011	<ul style="list-style-type: none"> • Pack of 5 pieces • Suitable for all regular modules • NOT for Head Stations

39 Glossary

Address	Unique number of a device connected to the network. With PROFIBUS this can be 0 to 126. 127 is a broadcast address.
Analyzer	Software tool to observe the protocol traffic. Combi-Analyzers can also inspect the signal quality. Other term: Bus Monitor. Example: ProfiTrace.
Bit Time (TBit)	To help simplify timing calculations, it is convenient to normalize the time units. One Bit Time is the time it takes to transmit one bit and is the reciprocal of the baudrate and is calculated as follows; $TBit = 1 \text{ (bit)} / \text{baudrate (bps)}$. Examples: 12 Mbps --> TBit = 83 ns 1,5 Mbps --> TBit = 667 ns
C	Capacitance.
Class 1 master	A class 1 master is normally a PLC or DCS system. The class 1 master handles the cyclical Data Exchange with the slaves assigned to it.
Class 2 master	A class 2 master is usually a laptop or programming console that is provided for commissioning, maintenance or diagnostic purposes.
Data Exchange	The state of a slave after parameterization and configuration has been completed, in which it cyclically exchanges I/O data with the master. Normally the slave stays forever in Data Exchange until the bus communication or device are stopped.
DGND	Digital Ground.
DIN	German Institute for Standardization (www.din.de).
DNS	Domain Name Service When ComBricks is sending an e-mail, it uses a DNS server to look up the domain name it is trying to access and convert it to an IP address. ComBricks uses a default DNS server, but if your email server does not support this one, you can enter an alternative DNS server.
DP-V0	DP-V0 is the basic stage of the PROFIBUS DP communication protocol. DP-V0 devices (master and slaves) perform the following basic functionalities: <ul style="list-style-type: none">• Cyclic exchange of I/O data between controlling and slave devices• Device, Identifier (module) and Channel related Diagnosis• Parameterization of DP-slaves• Configuration of DP-slaves

DP-V1	<p>DP-V1 is the first extension of PROFIBUS DP-V0. DP-V1 devices comply with the following features:</p> <ul style="list-style-type: none"> • Device related diagnosis is replaced by status and alarms. • The first three octets of the user parameterization data are standardized. <p>Optionally these devices may support:</p> <ul style="list-style-type: none"> • Acyclic communication (MS1, MS2). • If alarms are used, MS1 is supported.
DP-V2	<p>DP-V2 is the second stage of extension of PROFIBUS DP after DP-V1. DP-V2 devices shall comply with the following features:</p> <ul style="list-style-type: none"> • Data Exchange Broadcast (DxB) for slave to slave communication (publisher/subscriber principle). • Isochronous Mode (time tick synchronized operating slaves, e.g. drives) • Up- and/or download of Load Region Data (domains) • Clock Control (synchronization within slaves) and Time Stamping • Redundancy.
Drop cable	See <i>Spur line</i> .
Electromagnetic Compatibility	See <i>EMC</i> .
EMC	<p>The extent to which an electric or electronic device will tolerate electrical interference from other equipment (immunity), and will interfere with other equipment. Within the European Community as well as in other countries it is regulated by law that electric and electronic components and equipment comply with basic standards such as IEC 61000-6-2 or IEC 61326 or corresponding individual product standards.</p>
FDL	Fieldbus Datalink Layer. Layer 2 of PROFIBUS.
Flashing	<p>Function in the Discovery Tool that will blink the LEDs of a selected ComBricks. Flashing is a support feature that gives the user a visual confirmation about the installed location of the ComBricks.</p>
FTP	<p>File Transfer Protocol</p> <p>Allows a user to transfer files between two computers. The FTP client program runs on one computer and a server program on the other. FTP is primarily for transferring files but can be used to perform other functions: creating directories, removing directories, listing files, etc. It is TCP based.</p>
GSD file	<p>Generic Station Description.</p> <p>It is provided by the device manufacturer and contains a description of the PROFIBUS DP/PA device. GSD files provide a way for an open configuration tool to automatically get the device characteristics.</p>
Head Station	<p>The Head Station is the primary element of ComBricks and has to be inserted in the most left slot of the fixed backplane socket. It schedules the interaction between all modules and provides data storage and an Ethernet interface for the user.</p>

HSA	<p>Highest Station Address</p> <p>The highest address to which the master will look for new masters. This is done with the FDL Status message. It has nothing to do with the configured slaves! Default value is 126, but the end user can decrease it to a lower value. We recommend leaving it on 126 in order to display not configured slaves in the Live List. This value does not influence the I/O cycle time of the network.</p>
Hub	<p>A Hub refreshes a signal and passes the information on to all nodes which are connected to the Hub. Data frames which were received on one port are transferred to all the other ports (chicken foot topology).</p>
Ident Number	<p>The primary slave device identification is an Ident Number. This is a unique 16 bits number assigned by the PNO. It is stored within the device and defined in the corresponding GSD file. In addition it is part of the GSD file name. At runtime the Ident Number is used within the;</p> <ul style="list-style-type: none"> • Set slave address procedure • Parameterization telegram (byte 5 + 6) • Standard part of a diagnosis message (byte 5 + 6) <p>The Ident Number can be retrieved from a device. Its main purpose is to make sure that a GSD file and configuration/parameterization data between master class 1 and its slave are matching.</p>
LED	<p>Light Emitting Diode</p> <p>Indicators on devices to inform the user of its status.</p>
Live List	<p>The Live List is a matrix that lists all the available devices. It is directly visible which devices are 'troublemakers'. With different background colours the status of the devices is displayed. The Live List can also generate the product name of the devices when a diagnostic message is captured (synchronized with the GSD library).</p>
Module	<p>A card that can be inserted in the backplane of ComBricks.</p> <p>Examples of modules: repeaters, DP slaves or I/O cards.</p>
MPI	<p>Multiple Protocol Interface.</p> <p>Protocol defined by Siemens which uses the layer 1 and 2 of PROFIBUS (FDL).</p>
OE	<p><i>See ProfiTrace OE.</i></p>
PA	<p><i>See PROFIBUS PA.</i></p>
PB	<p>PROFIBUS.</p>

PROFIBUS DP	<p>Acronym for "PROFIBUS for Decentralized Peripherals". Specification of an open fieldbus system with the following characteristics:</p> <ul style="list-style-type: none"> • Polling master-slave-system (cyclic communications, MS0) • Flying masters with robin round token passing coordination (MM) • Connection based (MS1) and connectionless (MS2, MS3) acyclic communication between masters and slaves <p>Options (e.g.):</p> <ul style="list-style-type: none"> • Data exchange broadcast (DXB), i.e. slave to slaves communication • Isochronous mode of slaves • Clock synchronization • Redundancy <p>PROFIBUS DP is standardized within IEC 61158 and IEC 61784, communication profile families 3/1 and 3/2</p> <p>The term "PROFIBUS DP" also is a synonym for the RS485 based deployments within factory automation.</p>
PROFIBUS PA	<p>Acronym for "PROFIBUS for Process Automation". This is an application profile based on PROFIBUS DP independent from the physical profiles (RS485, Fiber Optics, MBP). The requirements of continuous manufacturing are covered within the application profile "PA-Devices" and the extension MBP to the physical profiles.</p>
ProfiTrace OE	<p>ProfiTrace Over Ethernet.</p> <p>A ProfiTrace core which has been implemented in ComBricks that permanently monitors the installation through the repeaters and visualizes the information in a web server.</p>
Reflection	<p>Part of the original signal that is transmitted back along the cable. It corrupts the original signal.</p>
Repeater	<p>Active physical layer device that receives and retransmits all signals over a different port to increase the distance and number of devices for which signals can be correctly transferred for a given medium.</p>
SD card	<p>Secure Digital (SD) is a non-volatile memory card format developed by the SD Card Association for use in portable devices, like: cameras, phones and game players. The SDHC (High-Capacity) card family has a capacity of 4 GB to 32 GB.</p>
Spur line	<p>A cable attached to a bus segment with a T-connection . Spurs are not recommended with PROFIBUS DP. They are prohibited with 12 Mbps and PROFIsafe operations. German term is "Stichleitung".</p>
Stub line	<p>See <i>Spur line</i>.</p>
TBit	<p>See <i>Bit Time</i>.</p>
TELNET	<p>TELEtype NETwork</p> <p>Is a network protocol used to make raw-TCP sessions (terminal-like access). Basically keyboard commands typed by a remote user can cross the network and become input for the server. On many operating systems the TELNET client program is available to communicate without specialized client software. It was developed in 1969.</p>

Termination	A (powered) resistor network at both ends of a segment to prevent reflections (with PROFIBUS DP the termination has to be powered).
Topology	In a communications network, the pattern of interconnection between network nodes; e.g. bus, ring, star configuration.

40 Revision history

Version 6.4.0

- Added paragraph 4.7.1
- Added paragraph 9.5
- Added note about DTM in monitoring mode, page 148.
- Added better explanation on ambient temperature in paragraph 3.1.

Version 6.4.1

- Updated chapter 42
- Updated chapter 43

Version 6.5.1

- Added paragraph 12.3.3

Version 6.5.2

- Updated paragraph 1.7
- Inserted new paragraph 4.4 (Diagnostic slave info)
- Added paragraph 4.13.6
- Updated paragraph 4.13
- Added paragraph 4.13.6
- Added paragraph 4.14
- Updated paragraph 5.1
- Updated paragraph 12.2.1
- Updated Technical Datasheets (chapters 20-36)
- Updated chapter 43

41 Other PROCENTEC products

PROFINET Cable Tester

- Suitable for 4- and 8-wire PROFINET and regular Ethernet cables
- Suitable for straight and 90°, metal or plastic PROFINET plugs
- Tests cable shielding
- Detects short circuits, wire breaks, swaps, miswiring and split pairs
- Large LCD clearly indicates the test results
- 150 hours on one 9 V battery
- Operating temperature: 0 to 50 °C
- Just 1-key-press to start continuous testing
- It can also test telephone and coax cable



www.profinetcabletester.com

Compact PROFIBUS Repeater

- Single channel PROFIBUS repeater
- Transparent
- Increased signal strength
- 12 Mbps
- Auto baudrate detection
- Redundant power supply
- Digital glitch filtering
- No limit in cascading
- Integrated switchable termination
- Diagnostic LEDs
- DB9 connector for measurements
- **IP 20 with DIN-rail mounting**



www.procentec.com/profihub/b1/en

ProfiHub B5+R

- 6 galvanically isolated channels
- Configurable grounding system
- Redundant power supply
- Bus redundancy option
- Star, tree and bus structured networks
- Alarm contact
- Monitoring port per channel
- IP20
- Certifications: UL Listed, DNV, FCC, CE

www.procentec.com/products/profihub

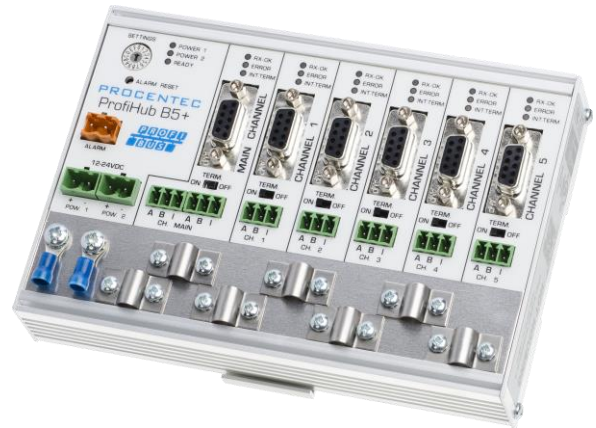

ProfiHub A5

- 5 Isolated channels
- Transparent
- Increased signal strength
- 31 devices per channel
- 12 Mbps
- 1200 m spur line length
- No address required
- Integrated switchable termination
- IP 65 classification

www.procentec.com/profihub



42 Sales offices and distributors

HEADQUARTERS

PROCENTEC
Klopperman 16
2292 JD WATERINGEN
Netherlands

T: +31-(0)174-671800
F: +31-(0)174-671801
E: info@procentec.com
I: www.procentec.com

ARGENTINA

eFALCOM
Alcorta 2411
B1744 - Moreno
Buenos Aires
Argentina

T: +54 237 46 31 151
F: +54 237 46 31 150
E: santiago.falcomer@efalcom.com
I: www.efalcom.com.ar

AUSTRALIA

IS Systems Pty Limited
14 Laverick Ave.,
Tomago
NSW, Australia, 2322

T: +61 2 4964 8548
F: +61 2 4964 8877
E: fritz.woller@issystems.com.au
I: www.issystems.com.au

Pentair Flow Control Pacific
1 Percival Road
Smithfield
NSW, Australia, 2164

T: +61 2 4448 0466
F: +61 2 4423 3232
E: sharee.hazell@pentair.com.au
I: www.profibuscentre.com.au

BELGIUM and LUXEMBOURG

Bintz Technics N.V.
Brixtonlaan 23
B-1930 Zaventem
Belgium

T: +32 2 720 49 16
F: +32 2 720 37 50
E: bloemen@bintz.be
I: www.bintz.be

BRAZIL

Westcon Instrument. Indl Ltda
Rual Alvaro Rodrigues, 257
São Paulo – SP
Brazil - CEP 04582-000

T: +55 11 5561-7488
F: +55 11 5093-2592
E: paolo@wii.com.br
I: www.wii.com.br

CANADA

Streamline Process Management Inc.
#3, 4351 – 104 Ave SE
Calgary, Alberta T2C 5C6
Canada

T: +1 403 225 1986
F: +1 587 585 2828
E: admin@streamlinepm.com
I: www.streamlinepm.com

CHILE

RP Ingenieria Limitada
Tucapel 92 oficina 52
Concepción
Chile

T: +56-(0)41-2469350
F: +56-(0)41-2522592
E: rodrigopinto@rpingeneria.cl
I: www.rpingeneria.cl

CHINA

PROCENTEC Beijing
Room E-1115 WangJingYuan YouLeHui
ChaoYang
Beijing
China

T: +86(10)84766911 or 84787311
F: +86(10)84766722
E: info@procentec.net
I: www.procentec.net

CZECH REPUBLIC

FOXON s.r.o.
Polní 367
460 01 Liberec 12
Czech Republic

T: +420 484 845 555
F: +420 484 845 556
E: foxon@foxon.cz
I: www.foxon.cz

DENMARK

ProSaiCon
Jernbanegade 23B
DK 4000 Roskilde
Denmark

T: +45 70 20 52 01
F: +45 70 20 52 02
E: hfj@prosaicon.dk
I: www.prosaicon.dk

EGYPT

Mas Trading
37, 105 Street
Al-Etihad Square
Egypt

T: +2 02 2524 2842
F: +2 02 2524 2843
E: aya.elshafei@masautomation.com
I: www.masautomation.com

MTSE
7, Amin Annis St., 4th Sec.
11341 Cairo
Egypt

T: +20 2 241 475 07
F: +20 2 229 031 60
E: hassan.mahdy@mtse.com.eg
I: www.mtse.com.eg

ESTONIA

Saksa Automaatika OU
Peterburi Tee 49
Tallinn
EE-11415 Estonia

T: +372 605 2526
F: +372 605 2524
E: info@saksa-automaatika.ee
I: www.saksa-automaatika.ee

FINLAND

Hantekno Oy
Kalliotie 2
04360 Tuusula
Finland

T: +358 40 8222 014
E: info@hantekno.com
I: www.hantekno.fi

FRANCE

AGILICOM
Bâtiment B
1, rue de la Briaudière
Z.A. La Châtaigneraie
37510 BALLAN-MIRE
France

T: +33 247 76 10 20
F: +33 247 37 95 54
E: jy.bois@agilicom.fr
I: www.agilicom.fr

GERMANY

PROCENTEC GmbH
Benzstrasse 15
D-76185 Karlsruhe
Germany

T: +49-(0)721 831 663-0
F: +49-(0)721 831 663-29
E: info@procentec.de
I: www.procentec.de

INDIA

UL Engineering Services & Software Pvt Ltd
Nirman Classic,
Katraj-Kondhwa Road,
Katraj, Pune-411046
India

T: +91-202 696 0050
F: +91-202 696 2079
E: dileep.miskin@ulepl.com
I: www.ulepl.com

IRELAND

PROFIBUS Ireland
Automation Research Centre
University of Limerick
National Technology Park, Plassey
Limerick
Ireland

T: +353-61-202107 or +35361240240
F: +353-61-202582
E: info@profibus.ie
I: www.profibus.ie

ISRAEL

Instrumentics Industrial Control
8 Hamlacha St.
New Industrial Zone
Netanya, 42170
Israel

T: +972-9-8357090
F: +972-9-8350619
E: info@instrumentics-ic.co.il
I: www.inst-ic.co.il

ITALY

PROCENTEC Italy
Via Branze n. 43/45
25123 Brescia
Italy

T: +39 030 200 8610
F: +39 030 238 0059
E: www.procentec.it
W: www.procentec.it

JAPAN

TJ Group
C/O Japanese PROFIBUS Organisation
West World Building 4F
3-1-6 Higashi-Gotanda,
Shinagawa-ku,
Tokyo, 141-0022
Japan

T: +81-3-6450-3739
F: +81-3-6450-3739
E: info@profibus.jp

KOREA

Hi-PRO Tech. Co., Ltd.
#2802, U-Tower, 1029
Youngduk-dong, Giheung-gu
Yongin-Si, Kyunggi-do,
446-908 Korea

T: +82 82-31-216-2640
F: +82 82-31-216-2644
E: chays@hiprotech.co.kr
I: www.profibus.co.kr

LEBANON

Industrial Technologies S.A.L. (ITEC)
Point Center, Boulevard Fouad Chehab
Sin El Fil
Beirut
Lebanon

T: +961 1 491161
F: +961 1 491162
E: sales@iteclb.com
I: www.iteclb.com

MEXICO

Grid Connect Inc.

T: +1 530-219-2565 (Spanish)
E: tomf@gridconnect.com
I: www.gridconnect.com

NETHERLANDS

PROCENTEC B.V.
Klopperman 16
2292 JD Wateringen
Netherlands

T: +31 (0)174 671800
F: +31 (0)174 671 801
E: info@procentec.com
I: www.procentec.com

NEW ZEALAND

Mantis Systems
34 Glasgow St.
Dunedin
New Zealand

T: +643 455 6072
F: +31 (0)174 671 801
E: tbaldock@mantis-sys.co.nz
I: www.mantis-sys.co.nz

NIGERIA

PowerPro Company Limited
DTN Complex, Off Lateef Jakande Road
Ikeja, Lagos
Nigeria

T: +234 909 019 8004
E: babangida@powerpro.ng
I: www.powerpro.ng

NORWAY

Nortelco Automation AS
Johan Scharffenbergs vei 95
N-0694 Oslo
Norway

T: +47 22 57 61 00
E: post@nortelcoautomation.no
I: www.nortelcoautomation.no

PAKISTAN

OTC
Suite No. 4, 1st Floor Liberty Heights
Main Boulevard Gulberg
Lahore - 54660
Pakistan

T: +92 42 3587 2667-9 Ext. 117
F: +92 42 3587 2670
E: nsm@otc.com.pk
I: www.otc.com.pk

PERU

ControlWare
Jr. Los Silicios 5409
Los Olivos - L39
Peru

T: +51 1637 3735
F: +51 1528 0454
E: info@controlware.com.pe
I: www.controlware.com.pe

POLAND

INTEX Sp. z o.o.
ul. Portowa 4
44-102 Gliwice
Poland

T: +48 32 230 75 16
F: +48 32 230 75 17
E: intex@intex.com.pl
I: www.intex.com.pl

ROMANIA

S.C. SVT Electronics S.R.L.
Brăila 7
540331 Tg-Mure
Romania

T: +40 365 809 305
F: +40 365 809 305
E: sajgo.tibor@svt.ro
I: www.svt.ro

SAUDI ARABIA

ASM Process Automation
Al-Zahra Dist. – Attas st.
cross section with helmy Kutby St.
Villa no.25
Jeddah-21553
Saudi Arabia

T: +966 2 691 2741
F: +966 2 682 8943
E: info@asmestablishment.com
I: www.asmeestablishment.com

SINGAPORE / SOUTH EAST ASIA

Allegro Electronics
236 Serangoon Avenue 3 07-98
Singapore 550236

T: +65 628 780 63
E: sales@allegro.com.sg
I: www.allegro.com.sg

Gissmatic Automatisierung Pte Ltd
318 Tanglin Road 01-34
Singapore 247979

T: +65 900 912 76
E: sales@gissmatic.com
I: www.gissmatic.com

SLOVAKIA

ControlSystem s.r.o.
Stúrova 4
977 01 BREZNO
Slovakia

T: +421 486115900
F: +421 486111891
E: jan.snopko@controlsystem.sk
W: www.controlsystem.sk

SOUTH AFRICA

IDX ONLINE CC
1 Weaver Street
Fourways
Johannesburg
South Africa - 2191

T: +27(11) 548 9960
F: +27(11) 465-8890
E: sales@idxonline.com
I: www.idxonline.com

SPAIN

LOGITEK, S.A
Ctra. de Sant Cugat, 63 Esc. B Planta 1ª
Rubí (BARCELONA), 08191
Spain

T: +34 93 588 6767
E: xavier.cardena@logitek.es
I: www.logitek.es

SWEDEN

P&L Nordic AB
Box 252
S-281 23 Hässleholm
Sweden

T: +46 451 74 44 00
F: +46 451 89 833
E: hans.maunsbach@pol.se
I: www.pol.se/profibus

SWITZERLAND

EME AG
Lohwisstrasse 50
CH-8123 Ebmatingen
Switzerland

T: +41 44 982 11 11
E: mhauri@eme.ch
I: www.eme.ch

TAIWAN

Orion Energy Technology
3F, No. 2, Aly. 6, Ln. 109, Sec. 2, Huanshan Rd.
Neihu District, Tapei City
114, Taiwan

T: +886 9 370 270 96
E: jackychiu76@gmail.com

TURKEY

Emikon Otomasyon
DES Sanayi sitesi 103 sokak
B-7 blok No:16 Yukari Dudullu / Umraniye
Istanbul 34776
Turkey

T: +90 216 420 8347
F: +90 216 420 8348
E: tolgaturunz@emikonotomasyon.com
I: www.emikonotomasyon.com

UNITED ARAB EMIRATES

Synergy Controls
907, IT Plaza Silicon Oasis :
Dubail
United Arab Emirates

T: +971 4 3262692
F: +971 4 3262693
E: sales@synergycontrols.ae

UNITED KINGDOM and N. Ireland

Verwer Training & Consultancy
5 Barclay Road
Poynton, Stockport
Cheshire SK12 1YY
United Kingdom

T: +44 (0)1625 871199
E: andy@verwertraining.com
I: www.verwertraining.com

Hi-Port Software
The Hub 2 Martin Close
Lee-on-Solent
Hampshire PO13 8LG
United Kingdom

T: +44 (0)8452 90 20 30
F: +44 (0)2392 552880
E: sales@hiport.co.uk
I: www.hiport.co.uk

iTech
Unit 1
Dukes Road
Troon
Ayrshire KA10 6QR
United Kingdom

T: +44 (0)1292 311 613
F: +44 (0)1292 311 578
E: sales@itech-troon.co.uk
I: www.itech-troon.co.uk

Parkelect Ltd.
84 Dargan Road
Belfast
BT3 9JU
N. Ireland

T: +44 2890 777743
F: +44 2890 777794
E: jgillan@parkelect.co.uk
I: www.parkelect.co.uk

UNITED STATES

Grid Connect Inc.
1630 W. Diehl Road
Naperville, Illinois 60563
USA

T: +1 630 245-1445
F: +1 630 245-1717
E: sales@gridconnect.com
I: www.gridconnect.com/procentec.html

VIETNAM

Bavitech Corporation
42 Truong Son Street
Ward 2, Tan Binh District
Ho Chi Minh City
Vietnam

T: +84-8-3547 0976
F: +84-8-3547 0977
E: hai.hoang@bavitech.com
I: www.bavitech.com

For the up to date list of the Sales Offices and Distributors see www.procentec.com/company/distributors/. If your country or region is not listed, please contact us. We are still searching for distributors who can cover complete areas or countries.

43 Certificates

Certificate of Compliance	
This certificate is issued under the conditions as described in the test report as mentioned below	
Certificate number:	10C01036CRT02
Product name:	COMbricks
Model number:	--
Serial number:	COMbricks head station: SN203,
(Product identification)	COMbricks 2Ch Repeater: SN101
Manufacturer:	Procentec
	Turfschipper 41
	2292 JC WATERINGEN
	The Netherlands
Measurements carried out on behalf of:	Procentec
	Turfschipper 41
	2292 JC WATERINGEN
	The Netherlands
Applicant's representative:	Mr. M. de Brabander
In the capacity of:	Manufacturer
Date of measurement:	2010 November, 4,5
The measurement results are laid down in report:	10C01036RPT02
The product has been examined according to ¹:	Emission: EN 55022 (2006) + A1 (2007), class A
	Immunity: EN 55024 (1998) + A1 (2001) + A2 (2003)
ijkstra advies, research & EMC Consultancy B.V. Vijzelmolenlaan 7 - NL-3447 GX Woerden The Netherlands Tel: +31 (0)348 430 979 Fax: +31 (0)348 430 645 Internet: www.dare.nl E-mail: info@dare.nl	 D. van der Vlugt Director Woerden, 2011 March, 15
The Standard for EMC- & Radio, Automotive and Electrical Safety DARE!! Consultancy	¹ Has been found in compliance with the harmonised standards under the EMC directive 2004/108/EC.

Certificate of Compliance

This certificate is issued under the conditions as described in the test report as mentioned below

Certificate number:

10C01037CRT02

Product name:

COMbricks

Model number:

--

Serial number:

(Product identification)

COMbricks head station: SN203,
COMbricks 2Ch Repeater: SN101

Manufacturer:

Procentec
Turfschipper 41
2292 JC WATERINGEN
The Netherlands

Measurements carried out on behalf of:

Procentec
Turfschipper 41
2292 JC WATERINGEN
The Netherlands

Applicant's representative:

Mr. M. de Brabander

In the capacity of:

Manufacturer

Date of measurement:

2010 November, 4,5

The measurement results are laid down in report:

10C01037RPT02

The product has been examined according to ¹:

Emission: 47 CFR 15, class A

Dijkstra Advies, Research & EMC Consultancy B.V.
Vijzelmolendijk 7 - NL-3447 GX Woerden
The Netherlands
Tel: +31 (0)348 430 979
Fax: +31 (0)348 430 645
Internet: www.dare.nl
E-mail: info@dare.nl

The Standard for EMC- & Radio, Automotive and Electrical Safety

DARE!!
Consultancy

D. van der Vlugt
Director



Woerden, 2011 March, 15

¹ Has been found in compliance with the harmonised standards under the EMC directive 2004/108/EC.

Certificate

PROFIBUS Nutzerorganisation e.V. grants to

PROCENTEC

Turfschipper 41, 2292JC Wateringen, The Netherlands

the Certificate No: **Z01776** for the PROFIBUS Device:

Model Name: PBS_001

Revision: V2.1; SW/FW: Version 2.1; HW: Version 1.3

GSD: PROC696F.GSD, File Version: 18-07-2013

This certificate confirms that the product has successfully passed the certification tests with the following scope:

<input checked="" type="checkbox"/> DP-V0	MS0, Sync, Freeze, Fail_Safe, Set_Slave_Add
<input checked="" type="checkbox"/> Physical Layer	RS485

Test Report Number: PCN174-DPS-02

Authorized Test Laboratory: PROCENTEC, Wateringen, The Netherlands

The tests were executed in accordance with the following documents:
"Test Specifications for PROFIBUS DP Slaves, Version 3.09, September 2008".

This certificate is granted according to the document:
"Framework for testing and certification of PROFIBUS and PROFINET products".

For all products that are placed in circulation by August 20, 2016 the certificate is valid for life.



(Official in Charge)

Board of PROFIBUS Nutzerorganisation e. V.



(Karsten Schneider)

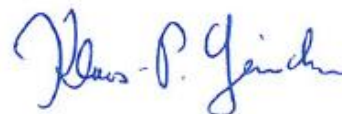

(K.-P. Lindner)

Certificate

PROFIBUS Nutzerorganisation e.V. grants to

PROCENTEC

Turfschipper 41, 2292JC Wateringen, The Netherlands

the Certificate No: **Z10500** for the PROFINET IO Device:

Model Name: PND-001
Revision: V1.0.0; SW/FW: V1.1.0; HW: 1
Identnumber: 0x4000; 0x0001
GSD: GSDML-V2.25-PROCENTEC-COMbricks PND_001-20120831.xml
DAP: DIM 1- DIM 10, Module ID 0x0001F900 - 909 together with PND-001, Module ID 0x00010500

This certificate confirms that the product has successfully passed the certification tests with the following PROFINET scope:

<input checked="" type="checkbox"/> Hardware	Auto_Negotiation, Auto_Polarity, Auto_Crossover
<input checked="" type="checkbox"/> Conformance Class B	RT_CLASS_1, RTA, LLDP, SNMP, MIB-II, LLDP-MIB

Test Report Number: PN194-1
Authorized Test Laboratory: SIEMENS AG, Fürth, Germany

The tests were executed in accordance with the following documents:
 "Test Specifications for PROFINET IO devices, Version 2.2.4 from December 2010" and
 "Test Cases for PN-Tester for PROFINET IO devices, Version 2.2.4.16.21".

This certificate is granted according to the document:
 "Framework for testing and certification of PROFIBUS and PROFINET products".

For all products that are placed in circulation by September 06, 2015 the certificate is valid for life.



(Official in Charge)

Board of PROFIBUS Nutzerorganisation e. V.

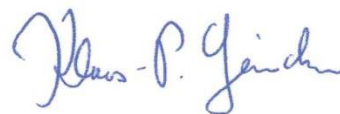

(Karsten Schneider)

(K.-P. Lindner)



44 About PROCENTEC

PROCENTEC is a specialist in PROFIBUS and PROFINET technology and develops products to optimize the production processes of end users. Our innovative solutions ensure that our customers successfully operate in the world of industrial automation and enjoy maximum results from their process.

PROCENTEC globally supplies all the components required to install a measurable and steerable network. We develop and produce all products in the Netherlands and they are exported through our worldwide distribution network. At PROCENTEC, we have a professional team of qualified support engineers who provide technical support on-site and online. Our professionals have more than 20 years of experience with PROFIBUS and PROFINET technology. They provide the necessary support to end users during implementation procedures, certification processes, audits and malfunctions. PROCENTEC also is the international accredited Competence and Training centre for PROFIBUS and PROFINET. We provide training courses that help employees using those techniques optimally for their business objectives.

Products

- ProfiTrace
- ComBricks
- ProfiHub
- PROFINET tools
- Cables and connectors

Training courses

- PROFIBUS training courses
- PROFINET training courses
- Product training courses

Services

- Competence centre
- Support & Consultancy
- Network certification & Audits
- Testlab & Democenter



PROCENTEC BV
Klopperman 16
2292 JD Wateringen
The Netherlands

T: +31 (0)174 671 800

F: +31 (0)174 671 801

E: support@procentec.com

W: www.procentec.com

